

MEDI-GLOBE
GROUP

UROTECH

MASTERING MEDICAL CHALLENGES BY INNOVATION.



TABLE OF CONTENT



URETERAL STENTS
Chapter 1



NEPHROSTOMY
Chapter 2



SUPRAPUBIC BLADDER
DRAINAGE
Chapter 3

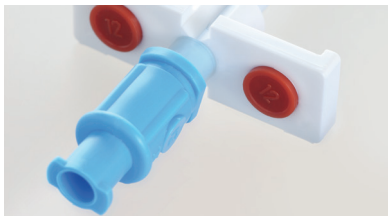

ACCESSORIES
Chapter 4



URETERAL CATHETERS
Chapter 5



FOLEY CATHETERS
Chapter 6



STONE BASKETS
Chapter 7



URODYNAMIC
Chapter 8



SPECIAL PRODUCTS
Chapter 9



SPECIAL PRODUCTS
Chapter 10



PEDIATRIC UROLOGY
Chapter 11



CONTACT INFORMATION

Order via Fax



+49 8032 973-393
(Order form on the back)

Order via e-mail



info@urotech.com

Order via mail



UROTECH GmbH
Medi-Globe-Straße 1-5
83101 Rohrdorf OT Achenmühle, Germany

FAX ORDER FORM
 to UROTECH GmbH
Telefax: +49 8032 973-393



Customer's Name: _____

Customer's ID: _____

Zipcode: _____

Contact Person: _____

Location: _____

Phone Number: _____

Order Code	Product	Quantity
1.		
2.		
3.		
4.		
5.		
6.		
7.		
8.		
9.		
10.		

Signature: _____

Date: _____

UROTECH
 Medi-Globe-Straße 1-5 · 83101 Rohrdorf OT Achenmühle, Germany
 ☎ +49 8032 973-450 · Fax: +49 8032 973-393
 info@urotech.com · www.urotech.com



CONVERSION TABLES Imperial to SI units

French / Charrière to Millimeters
1 FR/CH = 0.333 mm

French (FR) Charrière (CH)	Millimeters (mm)
01	0.333
02	0.667
03	1.000
04	1.333
04.7	1.565
05	1.667
06	2.000
07	2.333
08	2.667
09	3.000
10	3.333
11	3.667
12	4.000
14	4.667
16	5.333
18	6.000
20	6.667
22	7.333
24	8.000
26	8.667

Inches to Millimeters
1 in = 25.4 mm

Inches (in)	Millimeters (mm)
0.010	0.254
0.020	0.508
0.025	0.635
0.028	0.711
0.030	0.762
0.032	0.813
0.035	0.889
0.038	0.965
0.040	1.016
0.045	1.143
0.050	1.270
0.060	1.524
0.080	2.032
0.100	2.540
0.200	5.080
0.400	10.160
0.600	15.240
0.800	20.320
0.900	22.860
1.000	25.400

COLOURCODES FOR BALLOON CATHETER

French (FR) Charrière (CH)	Colour
6	Brown
8	Blue
10	Black
12	White
14	Green
16	Orange
18	Red
20	Yellow
22	Purple
24	Dark blue
26	Pink
28	Green
30	Grey

URETERAL STENTS



URETERAL STENTS

Variations overview

YELLOW-STAR

- ♦ Polyurethane (PUR)
- ♦ Phosphorylcholine (PC)-treatment to minimise the risk of infection and encrustation
- ♦ Very suitable for long term indwelling time



WHITE-STAR

- ♦ Polyurethane (PUR)
- ♦ Standard stent – available in many different versions



GREEN-STAR

- ♦ Polyurethane (PUR)
- ♦ Special soft material for high patient comfort



BLACK-STAR

- ♦ Polyurethane (PUR)
- ♦ With magnet



URETERAL STENTS

Introduction and general information

Introduction

On the following pages, we would like to provide you with a comprehensive portfolio of our ureteral stents. Regardless of the indication, you are sure to find the appropriate product here.

Material

Polyurethane (PUR)

All UROTECH ureteral stents are produced from aliphatic polyurethane (PUR) that has been specifically developed for medical applications. Unlike other materials, PUR shows minimal adhesion to blood cells and has a very low-grade inflammatory effect on tissue due to its physical and chemical properties. PUR becomes soft in a moist environment at body temperature, significantly limiting the risks of traumatic injury to surrounding tissue. Experimental tests and practical experience have shown that PUR is one of the

least thrombogenic and most tissue-compatible materials for implantable medical products.

Indwelling time

All UROTECH ureteral stents are approved for long-term use and can remain inside a patient for several months. The additional layer of phosphorylcholine (PC) on the ureteral stents significantly reduces the risk of encrustation and infection. However, due to the heterogeneity of indications and individual differences between patients, regular follow-up examinations should be performed by the treating physician.

Length measurements

In accordance with international norms (ASTMF-1828), the length of our ureteral stents is always indicated without including the J-tip – this equals the shaft length (Fig. 1).

Variations

In addition to our large catalog of standard ureteral stents, you can order many different custom variations based on your clinical needs.

E.g. stents:

- 🔴 with attached suture
- 🔴 without drainage openings in shaft

Fig. 1

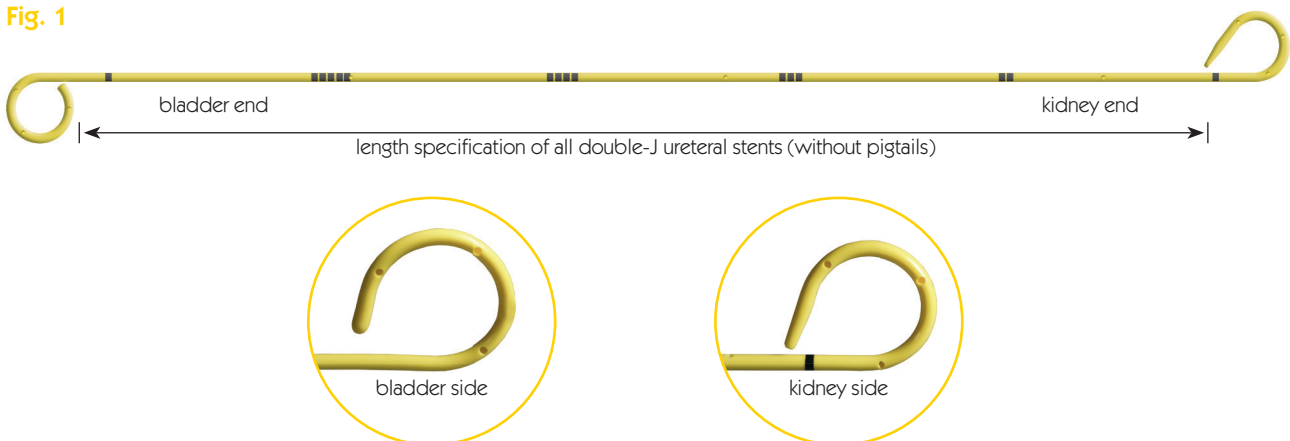

(1) Referenzen: Russel JC.; Bacteria, Biofilm and Devices: The Possible Protective Role of Phosphorylcholine Materials; J. Endourology 2000; 14(1): 39-42
 Stickler DJ, Evans A. et al.; Strategies for the control of catheter encrustation; Int. J. of Antimicrobial Agents 2002; 19(6): 499-506
 Heidenreich A, Becker T. et al.; Morbidity of internal Ureteral Stents: Prospective randomized Trial of Polyurethane versus Phosphorylcholine-treated Stents; Poster # 139 XVIIth Congress of European Association of Urology (EAU) Birmingham 2002

URETERAL STENTS

YELLOW-STAR



YELLOW-STAR Double-J Ureteral Stent-Set Treated with PC

SET COMPONENTS

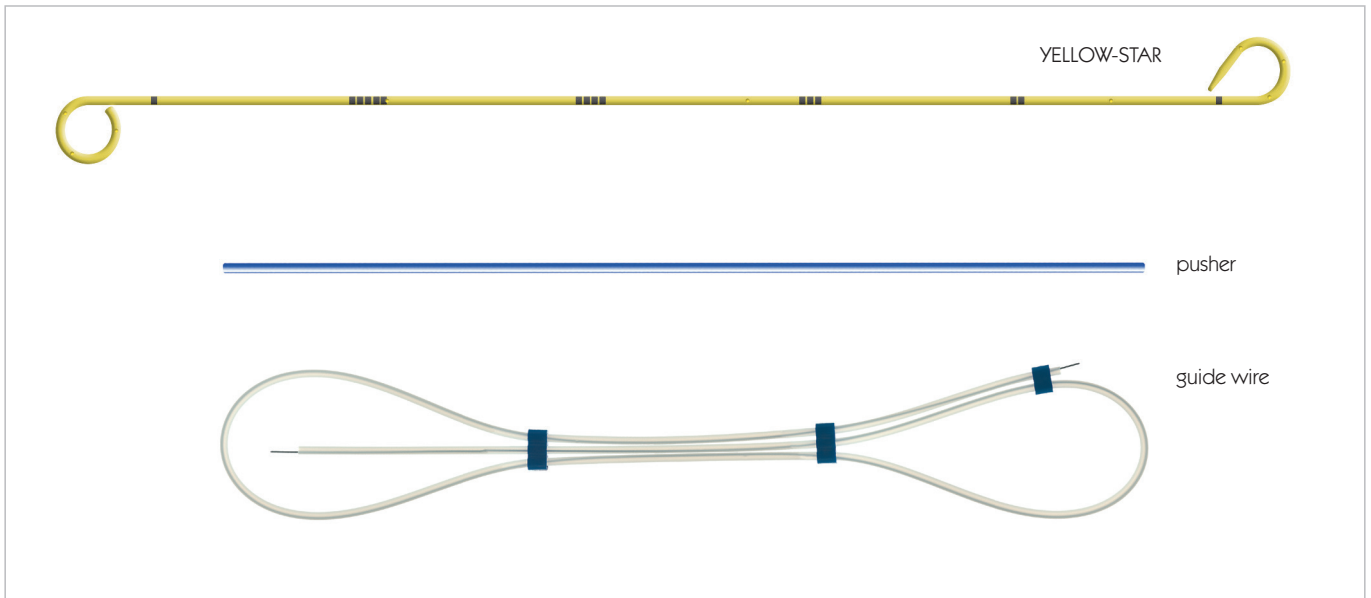

Ureteral Stent

- ◆ Polyurethane (PUR)
- ◆ PC-treatment to minimise risk of infection and encrustation, resulting in extended indwelling time
- ◆ Drainage openings in pigtails and shaft
- ◆ Open or closed tip
- ◆ Markings for exact positioning
- ◆ Radiopaque

Pusher

- ◆ Length: 40 cm

Guide Wire

- ◆ PTFE-coated

Clamp

- ◆ Only in sets with closed tip



YELLOW-STAR Double-J Ureteral Stent-Set

Treated with PC

Open tip							
Size (FR/CH)	Length (cm)	Order Code without Guide Wire	Order Code with Guide Wire	Guide Wire Length (cm)	Guide Wire Diameter	Guide Wire Tip	Guide Wire Stiffness
4.7	24	EP-414724	EP-364724	125	0.028"	straight	standard
4.7	26	EP-414726	EP-364726	125	0.028"	straight	standard
06	24	EP-410624	EP-360624	125	0.035"	straight	standard
06	26	EP-410626	EP-360626	125	0.035"	straight	standard
06	28	EP-410628	EP-360628	125	0.035"	straight	standard
06	30	EP-410630	EP-360630	125	0.035"	straight	standard
07	24	EP-410724	EP-360724	125	0.035"	straight	standard
07	26	EP-410726	EP-360726	125	0.035"	straight	standard
07	28	EP-410728	EP-360728	125	0.035"	straight	standard
07	30	EP-410730	EP-360730	125	0.035"	straight	standard
08	24	EP-410824	EP-360824	125	0.035"	straight	standard
08	26	EP-410826	EP-360826	125	0.035"	straight	standard
08	28	EP-410828	EP-360828	125	0.035"	straight	standard
08	30	EP-410830	EP-360830	125	0.035"	straight	standard

Closed tip							
Size (FR/CH)	Length (cm)		Order Code with Guide Wire	Guide Wire Length (cm)	Guide Wire Diameter	Guide Wire Tip	Guide Wire Stiffness
4.7	24		EP-394724	125	0.028"	straight	standard
4.7	26		EP-394726	125	0.028"	straight	standard
06	24		EP-390624	125	0.035"	straight	standard
06	26		EP-390626	125	0.035"	straight	standard
06	28		EP-390628	125	0.035"	straight	standard
06	30		EP-390630	125	0.035"	straight	standard
07	24		EP-390724	125	0.035"	straight	standard
07	26		EP-390726	125	0.035"	straight	standard
07	28		EP-390728	125	0.035"	straight	standard
07	30		EP-390730	125	0.035"	straight	standard
08	24		EP-390824	125	0.035"	straight	standard
08	26		EP-390826	125	0.035"	straight	standard
08	28		EP-390828	125	0.035"	straight	standard
08	30		EP-390830	125	0.035"	straight	standard

YELLOW-STAR Double-J Ureteral Stent-Set Treated with PC, flexible length

SET COMPONENTS

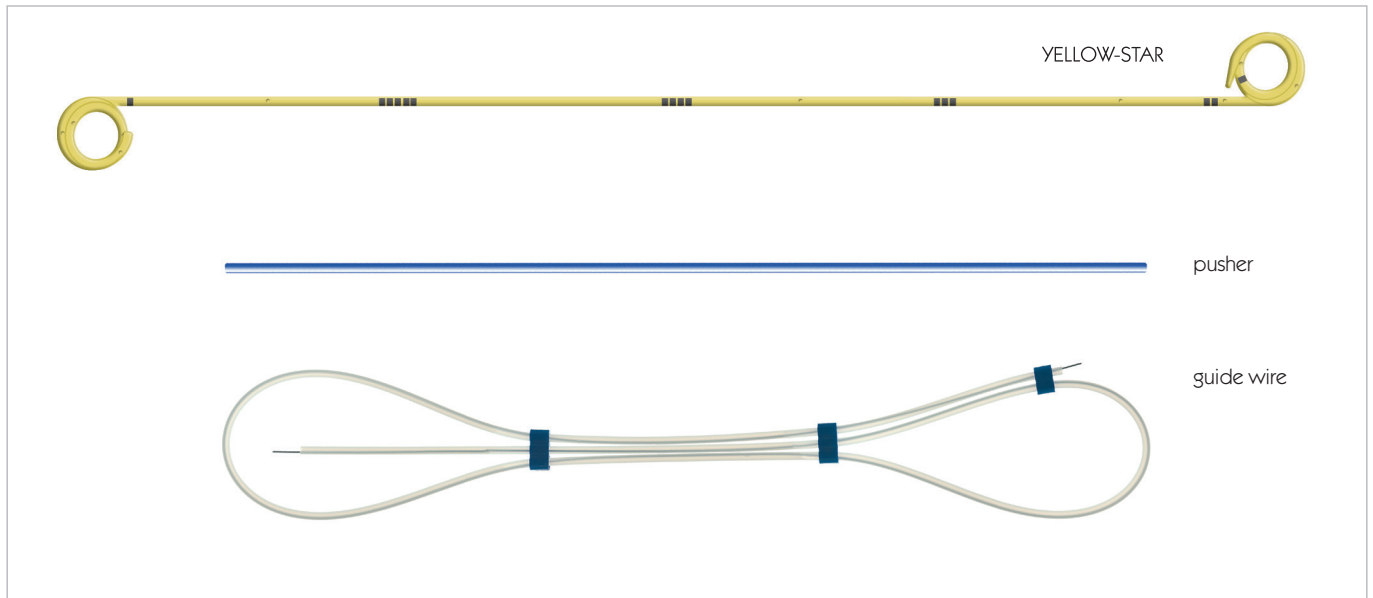

Ureteral Stent

- ◆ Polyurethane (PUR)
- ◆ PC-treatment to minimise risk of infection and encrustation, resulting in extended indwelling time
- ◆ Multiple coils on both ends for flexible shaft length from 22 to 30 cm
- ◆ Less risk of dislocation
- ◆ Drainage openings in pigtails and shaft
- ◆ Open or closed tip
- ◆ Markings for exact positioning
- ◆ Radiopaque

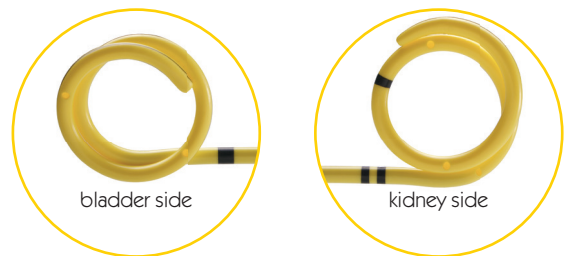

Pusher

- ◆ Length: 40 cm

Guide Wire

- ◆ PTFE-coated

Clamp

- ◆ Only in sets with closed tip



YELLOW-STAR Double-J Ureteral Stent-Set
Treated with PC, flexible length

Open tip							
Size (FR/CH)	Length (cm)	Order Code without Guide Wire	Order Code with Guide Wire	Guide Wire Length (cm)	Guide Wire Diameter	Guide Wire Tip	Guide Wire Stiffness
4.7	22-30	EP-414722-30-BS	EP-364722-30-BS	125	0.028"	straight	standard
06	22-30	EP-410622-30-BS	EP-360622-30-BS	125	0.035"	straight	standard
07	22-30	EP-410722-30-BS	EP-360722-30-BS	125	0.035"	straight	standard
08	22-30	EP-410822-30-BS	EP-360822-30-BS	125	0.035"	straight	standard

Closed tip							
Size (FR/CH)	Length (cm)		Order Code with Guide Wire	Guide Wire Length (cm)	Guide Wire Diameter	Guide Wire Tip	Guide Wire Stiffness
4.7	22-30		EP-394722-30-BS	125	0.028"	straight	standard
06	22-30		EP-390622-30-BS	125	0.035"	straight	standard
07	22-30		EP-390722-30-BS	125	0.035"	straight	standard
08	22-30		EP-390822-30-BS	125	0.035"	straight	standard

YELLOW-STAR Double-J Ureteral Stent-Set Treated with PC, steerable

SET COMPONENTS



Ureteral Stent

- ◆ Polyurethane (PUR)
- ◆ PC-treatment to minimise risk of infection and encrustation, resulting in extended indwelling time
- ◆ Drainage openings in pigtails and shaft
- ◆ Open or closed tip
- ◆ Markings for exact positioning
- ◆ Radiopaque

Steering Device

- ◆ Pusher
- ◆ Disconnecter
- ◆ Length: 53 cm

Guide Wire

- ◆ PTFE-coated

Clamp

- ◆ Only in sets with closed tip



YELLOW-STAR Double-J Ureteral Stent-Set
Treated with PC, steerable

Open tip							
Size (FR/CH)	Length (cm)	Order Code without Guide Wire	Order Code with Guide Wire	Guide Wire Length (cm)	Guide Wire Diameter	Guide Wire Tip	Guide Wire Stiffness
4.7	24		EP-484724	145	0.028"	straight	standard
4.7	26	EP-474726	EP-484726	145	0.028"	straight	standard
06	24	EP-470624	EP-480624	150	0.035"	straight	standard / movable core
06	26	EP-470626	EP-480626	150	0.035"	straight	standard / movable core
06	28	EP-470628	EP-480628	150	0.035"	straight	standard / movable core
06	30	EP-470630	EP-480630	150	0.035"	straight	standard / movable core
07	24	EP-470724	EP-480724	150	0.035"	straight	standard / movable core
07	26	EP-470726	EP-480726	150	0.035"	straight	standard / movable core
07	28	EP-470728	EP-480728	150	0.035"	straight	standard / movable core
07	30	EP-470730	EP-480730	150	0.035"	straight	standard / movable core
08	24		EP-480824	150	0.035"	straight	standard / movable core
08	26	EP-470826	EP-480826	150	0.035"	straight	standard / movable core
08	28	EP-470828	EP-480828	150	0.035"	straight	standard / movable core
08	30	EP-470830	EP-480830	150	0.035"	straight	standard / movable core

YELLOW-STAR Double-J Ureteral Stent-Set Treated with PC, steerable with coupling

SET COMPONENTS

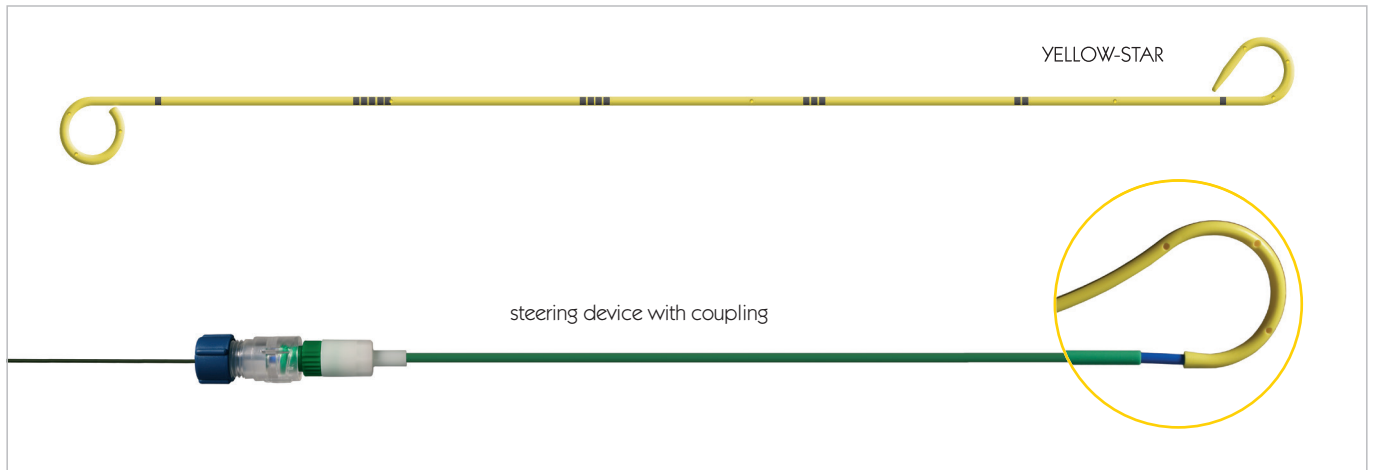

Ureteral Stent

- ◆ Polyurethane (PUR)
- ◆ PC-treatment to minimise risk of infection and encrustation, resulting in extended indwelling time
- ◆ Drainage openings in pigtails and shaft
- ◆ Open or closed tip
- ◆ Markings for exact positioning
- ◆ Radiopaque

Steering Device with Coupling

- ◆ Pusher
- ◆ Disconnecter
- ◆ Coupling to fasten guide wire
- ◆ Length: 43 cm

Guide Wire

- ◆ PTFE-coated

YELLOW-STAR Double-J Ureteral Stent-Set

Treated with PC, steerable with coupling

Open tip							
Size (FR/CH)	Length (cm)	Order Code without Guide Wire	Order Code with Guide Wire	Guide Wire Length (cm)	Guide Wire Diameter	Guide Wire Tip	Guide Wire Stiffness
4.7	24	EP-574724	EP-584724	145	0.028"	straight	standard
4.7	26	EP-574726	EP-584726	145	0.028"	straight	standard
06	24	EP-570624	EP-580624	150	0.035"	straight	standard / movable core
06	26	EP-570626	EP-580626	150	0.035"	straight	standard / movable core
06	28	EP-570628	EP-580628	150	0.035"	straight	standard / movable core
06	30	EP-570630	EP-580630	150	0.035"	straight	standard / movable core
07	24	EP-570724	EP-580724	150	0.035"	straight	standard / movable core
07	26	EP-570726	EP-580726	150	0.035"	straight	standard / movable core
07	28	EP-570728	EP-580728	150	0.035"	straight	standard / movable core
07	30	EP-570730	EP-580730	150	0.035"	straight	standard / movable core
08	24		EP-580824	150	0.035"	straight	standard / movable core
08	26	EP-570826	EP-580826	150	0.035"	straight	standard / movable core
08	28	EP-570828	EP-580828	150	0.035"	straight	standard / movable core

Closed tip							
Size (FR/CH)	Length (cm)		Order Code with Guide Wire	Guide Wire Length (cm)	Guide Wire Diameter	Guide Wire Tip	Guide Wire Stiffness
4.7	24		EP-594724	125	0.028"	straight	standard
4.7	26		EP-594726	125	0.028"	straight	standard
06	24		EP-590624	125	0.035"	J-tip	standard / movable core
06	26		EP-590626	125	0.035"	J-tip	standard / movable core
06	28		EP-590628	125	0.035"	J-tip	standard / movable core
06	30		EP-590630	125	0.035"	J-tip	standard / movable core
07	24		EP-590724	125	0.035"	J-tip	standard / movable core
07	26		EP-590726	125	0.035"	J-tip	standard / movable core
07	28		EP-590728	125	0.035"	J-tip	standard / movable core
07	30		EP-590730	125	0.035"	J-tip	standard / movable core
08	24		EP-590824	125	0.035"	J-tip	standard / movable core
08	26		EP-590826	125	0.035"	J-tip	standard / movable core
08	28		EP-590828	125	0.035"	J-tip	standard / movable core
08	30		EP-590830	125	0.035"	J-tip	standard / movable core

URETERAL STENTS

WHITE-STAR



WHITE-STAR Double-J Ureteral Stent-Set

SET COMPONENTS

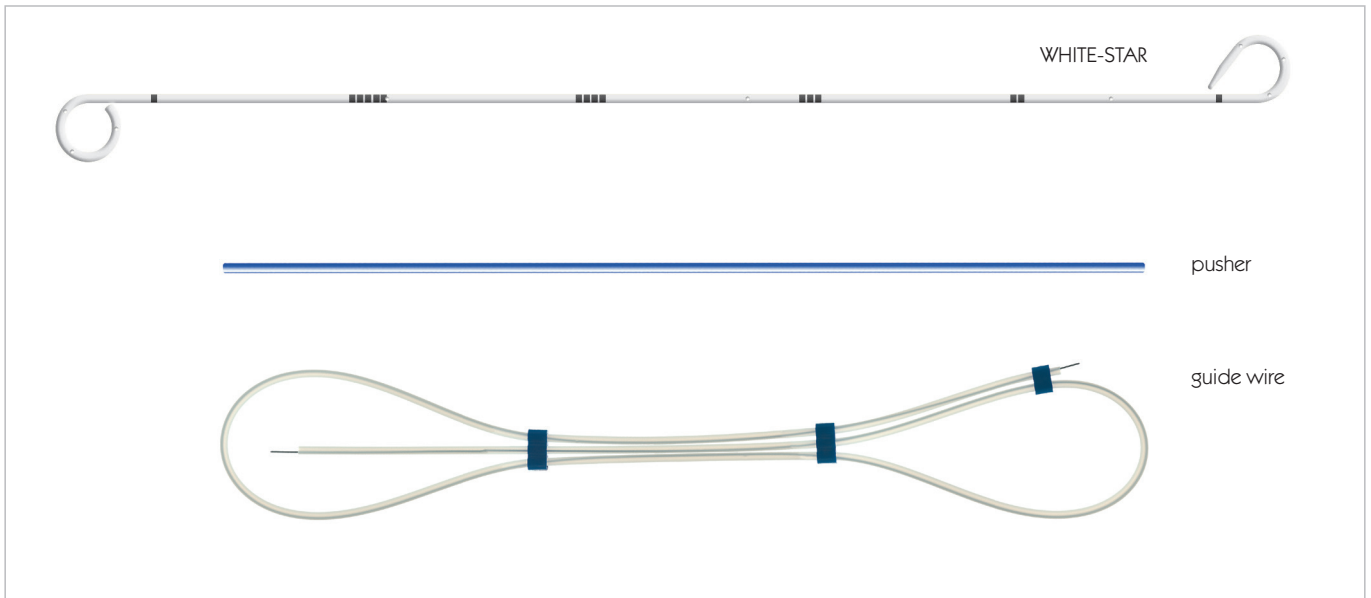

Ureteral Stent

- ◆ Polyurethane (PUR)
- ◆ Drainage openings in pigtails and shaft
- ◆ Open or closed tip
- ◆ Markings for exact positioning
- ◆ Radiopaque

Pusher

- ◆ Length: 40 cm

Guide Wire

- ◆ PTFE-coated

Clamp

- ◆ 2 clamps in sets with closed tip



WHITE-STAR Double-J Ureteral Stent-Set

Open tip							
Size (FR/CH)	Length (cm)	Order Code without Guide Wire	Order Code with Guide Wire	Guide Wire Length (cm)	Guide Wire Diameter	Guide Wire Tip	Guide Wire Stiffness
4.7	24	EN-410524	EN-360524	125	0.028"	straight	standard
4.7	26	EN-410526	EN-360526	125	0.028"	straight	standard
06	24	EN-410624	EN-360624	125	0.035"	straight	standard
06	26	EN-410626	EN-360626	125	0.035"	straight	standard
06	28	EN-410628	EN-360628	125	0.035"	straight	standard
06	30	EN-410630	EN-360630	125	0.035"	straight	standard
07	24	EN-410724	EN-360724	125	0.035"	straight	standard
07	26	EN-410726	EN-360726	125	0.035"	straight	standard
07	28	EN-410728	EN-360728	125	0.035"	straight	standard
07	30	EN-410730	EN-360730	125	0.035"	straight	standard
08	24	EN-410824	EN-360824	125	0.035"	straight	standard
08	26	EN-410826	EN-360826	125	0.035"	straight	standard
08	28	EN-410828	EN-360828	125	0.035"	straight	standard
08	30	EN-410830	EN-360830	125	0.035"	straight	standard

Closed tip							
Size (FR/CH)	Length (cm)	Order Code without Guide Wire	Order Code with Guide Wire	Guide Wire Length (cm)	Guide Wire Diameter	Guide Wire Tip	Guide Wire Stiffness
4.7	24	EN-400524	EN-300524	125	0.028"	straight	standard
4.7	26	EN-400526	EN-300526	125	0.028"	straight	standard
06	24	EN-400624	EN-300624	125	0.035"	straight	standard
06	26	EN-400626	EN-300626	125	0.035"	straight	standard
06	28	EN-400628	EN-300628	125	0.035"	straight	standard
06	30	EN-400630	EN-300630	125	0.035"	straight	standard
07	24	EN-400724	EN-300724	125	0.035"	straight	standard
07	26	EN-400726	EN-300726	125	0.035"	straight	standard
07	28	EN-400728	EN-300728	125	0.035"	straight	standard
07	30	EN-400730	EN-300730	125	0.035"	straight	standard
08	24	EN-400824	EN-300824	125	0.035"	straight	standard
08	26	EN-400826	EN-300826	125	0.035"	straight	standard
08	28	EN-400828	EN-300828	125	0.035"	straight	standard
08	30		EN-300830	125	0.035"	straight	standard

WHITE-STAR Double-J Ureteral Stent-Set

Flexible length

SET COMPONENTS

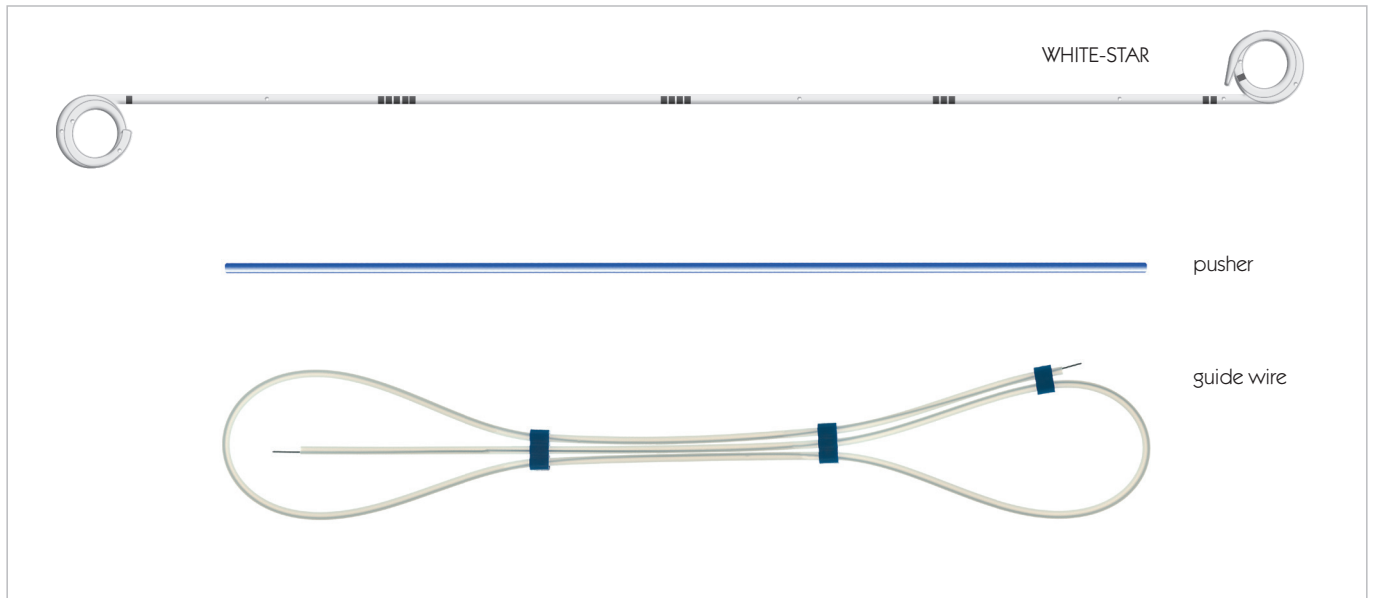

Ureteral Stent

- ◆ Polyurethane (PUR)
- ◆ Multiple coils on both ends for flexible shaft length from 22 to 30 cm
- ◆ Less risk of dislocation
- ◆ Drainage openings in pigtails and shaft
- ◆ Open or closed tip
- ◆ Markings for exact positioning
- ◆ Radiopaque



Pusher

- ◆ Length: 40 cm

Guide Wire

- ◆ PTFE-coated

Clamp

- ◆ 2 clamps in sets with closed tip



WHITE-STAR Double-J Ureteral Stent-Set

Flexible length

Open tip							
Size (FR/CH)	Length (cm)	Order Code without Guide Wire	Order Code with Guide Wire	Guide Wire Length (cm)	Guide Wire Diameter	Guide Wire Tip	Guide Wire Stiffness
06	22-30	EN-410622-30-BS	EN-360622-30-BS	125	0.035"	straight	standard
07	22-30	EN-410722-30-BS	EN-360722-30-BS	125	0.035"	straight	standard
08	22-30	EN-410822-30-BS	EN-360822-30-BS	125	0.035"	straight	standard

Closed tip							
Size (FR/CH)	Length (cm)		Order Code with Guide Wire	Guide Wire Length (cm)	Guide Wire Diameter	Guide Wire Tip	Guide Wire Stiffness
06	22-30		EN-390622-30-BS	125	0.035"	straight	standard
07	22-30		EN-390722-30-BS	125	0.035"	straight	standard
08	22-30		EN-390822-30-BS	125	0.035"	straight	standard

WHITE-STAR Double-J Ureteral Stent-Set Steerable

SET COMPONENTS

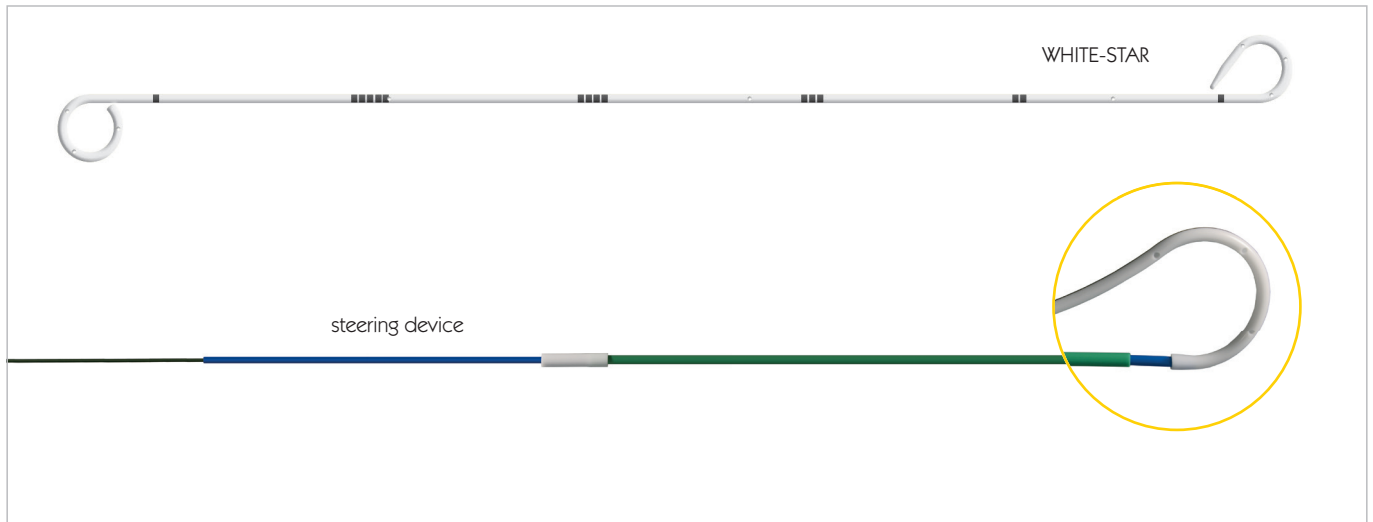

Ureteral Stent

- ◆ Polyurethane (PUR)
- ◆ Drainage openings in pigtails and shaft
- ◆ Open or closed tip
- ◆ Markings for exact positioning
- ◆ Radiopaque

Steering Device

- ◆ Pusher
- ◆ Disconnecter
- ◆ Length: 53 cm

Guide Wire

- ◆ PTFE-coated

Clamp

- ◆ 2 clamps in sets with closed tip



WHITE-STAR Double-J Ureteral Stent-Set

Steerable

Open tip							
Size (FR/CH)	Length (cm)	Order Code without Guide Wire	Order Code with Guide Wire	Guide Wire Length (cm)	Guide Wire Diameter	Guide Wire Tip	Guide Wire Stiffness
4.7	24	ES-360524	ES-370524	145	0.028"	straight	standard
4.7	26	ES-360526	ES-370526	145	0.028"	straight	standard
06	24	ES-360624	ES-370624	150	0.035"	straight	standard / movable core
06	26	ES-360626	ES-370626	150	0.035"	straight	standard / movable core
06	28	ES-360628	ES-370628	150	0.035"	straight	standard / movable core
06	30	ES-360630	ES-370630	150	0.035"	straight	standard / movable core
07	24	ES-360724	ES-370724	150	0.035"	straight	standard / movable core
07	26	ES-360726	ES-370726	150	0.035"	straight	standard / movable core
07	28	ES-360728	ES-370728	150	0.035"	straight	standard / movable core
07	30	ES-360730	ES-370730	150	0.035"	straight	standard / movable core
08	24		ES-370824	150	0.035"	straight	standard / movable core
08	26	ES-360826	ES-370826	150	0.035"	straight	standard / movable core
08	28	ES-360828	ES-370828	150	0.035"	straight	standard / movable core
08	30	ES-360830	ES-370830	150	0.035"	straight	standard / movable core

Closed tip							
Size (FR/CH)	Length (cm)		Order Code with Guide Wire	Guide Wire Length (cm)	Guide Wire Diameter	Guide Wire Tip	Guide Wire Stiffness
4.7	24		ES-380524	125	0.028"	straight	standard
4.7	26		ES-380526	125	0.028"	straight	standard
06	24		ES-380624	125	0.035"	J-tip	standard / movable core
06	26		ES-380626	125	0.035"	J-tip	standard / movable core
06	28		ES-380628	125	0.035"	J-tip	standard / movable core
06	30		ES-380630	125	0.035"	J-tip	standard / movable core
07	26		ES-380726	125	0.035"	J-tip	standard / movable core
07	28		ES-380728	125	0.035"	J-tip	standard / movable core
07	30		ES-380730	125	0.035"	J-tip	standard / movable core

WHITE-STAR Double-J Ureteral Stent-Set Steerable with coupling

SET COMPONENTS

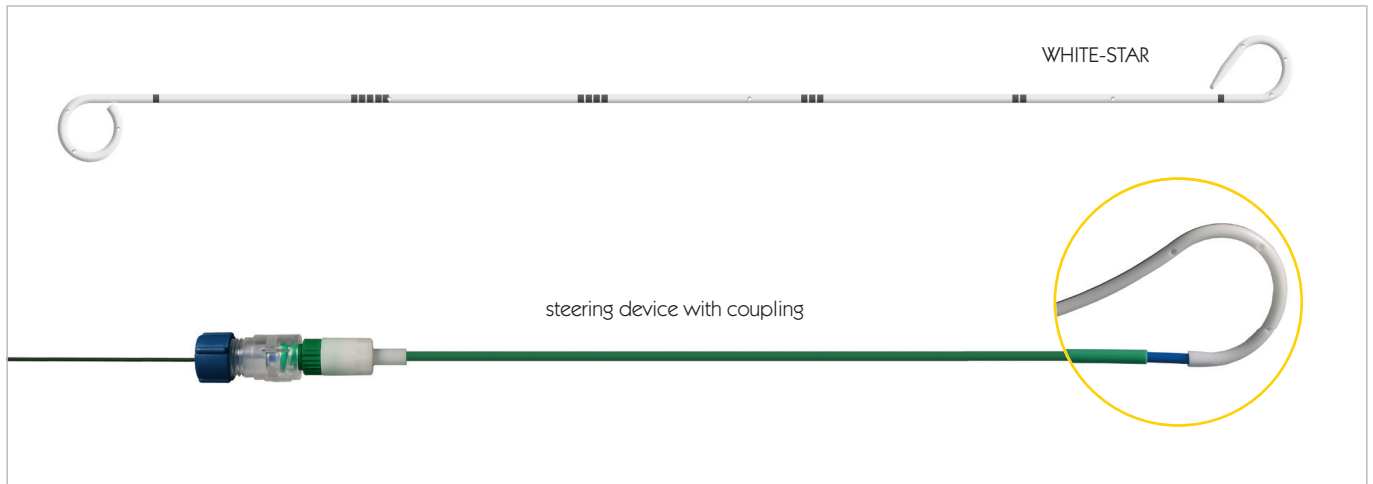

Ureteral Stent

- ◆ Polyurethane (PUR)
- ◆ Drainage openings in pigtails and shaft
- ◆ Open or closed tip
- ◆ Markings for exact positioning
- ◆ Radiopaque

Steering Device with Coupling

- ◆ Pusher
- ◆ Disconnecter
- ◆ Coupling to fasten guide wire
- ◆ Length: 43 cm

Guide Wire

- ◆ PTFE-coated

WHITE-STAR Double-J Ureteral Stent-Set
Steerable with coupling

Open tip							
Size (FR/CH)	Length (cm)	Order Code without Guide Wire	Order Code with Guide Wire	Guide Wire Length (cm)	Guide Wire Diameter	Guide Wire Tip	Guide Wire Stiffness
4.7	24	ES-570524	ES-580524	145	0.028"	straight	standard
4.7	26	ES-570526	ES-580526	145	0.028"	straight	standard
06	24		ES-580624	150	0.035"	straight	standard / movable core
06	26	ES-570626	ES-580626	150	0.035"	straight	standard / movable core
06	28	ES-570628	ES-580628	150	0.035"	straight	standard / movable core
06	30	ES-570630	ES-580630	150	0.035"	straight	standard / movable core
07	24	ES-570724		150	0.035"	straight	standard / movable core
07	26	ES-570726	ES-580726	150	0.035"	straight	standard / movable core
07	28	ES-570728	ES-580728	150	0.035"	straight	standard / movable core
07	30	ES-570730	ES-580730	150	0.035"	straight	standard / movable core
08	24		ES-580824	150	0.035"	straight	standard / movable core
08	26	ES-570826	ES-580826	150	0.035"	straight	standard / movable core
08	28		ES-580828	150	0.035"	straight	standard / movable core
08	30		ES-580830	150	0.035"	straight	standard / movable core

Closed tip							
Size (FR/CH)	Length (cm)		Order Code with Guide Wire	Guide Wire Length (cm)	Guide Wire Diameter	Guide Wire Tip	Guide Wire Stiffness
4.7	24		ES-590524	125	0.028"	straight	standard
4.7	26		ES-590526	125	0.028"	straight	standard
06	24		ES-590624	125	0.035"	J-tip	standard / movable core
06	26		ES-590626	125	0.035"	J-tip	standard / movable core
06	28		ES-590628	125	0.035"	J-tip	standard / movable core
06	30		ES-590630	125	0.035"	J-tip	standard / movable core
07	24		ES-590724	125	0.035"	J-tip	standard / movable core
07	26		ES-590726	125	0.035"	J-tip	standard / movable core
07	28		ES-590728	125	0.035"	J-tip	standard / movable core
07	30		ES-590730	125	0.035"	J-tip	standard / movable core
08	24		ES-590824	125	0.035"	J-tip	standard / movable core
08	26		ES-590826	125	0.035"	J-tip	standard / movable core

WHITE-STAR MONO Mono-J Ureteral Stent-Set

SET COMPONENTS

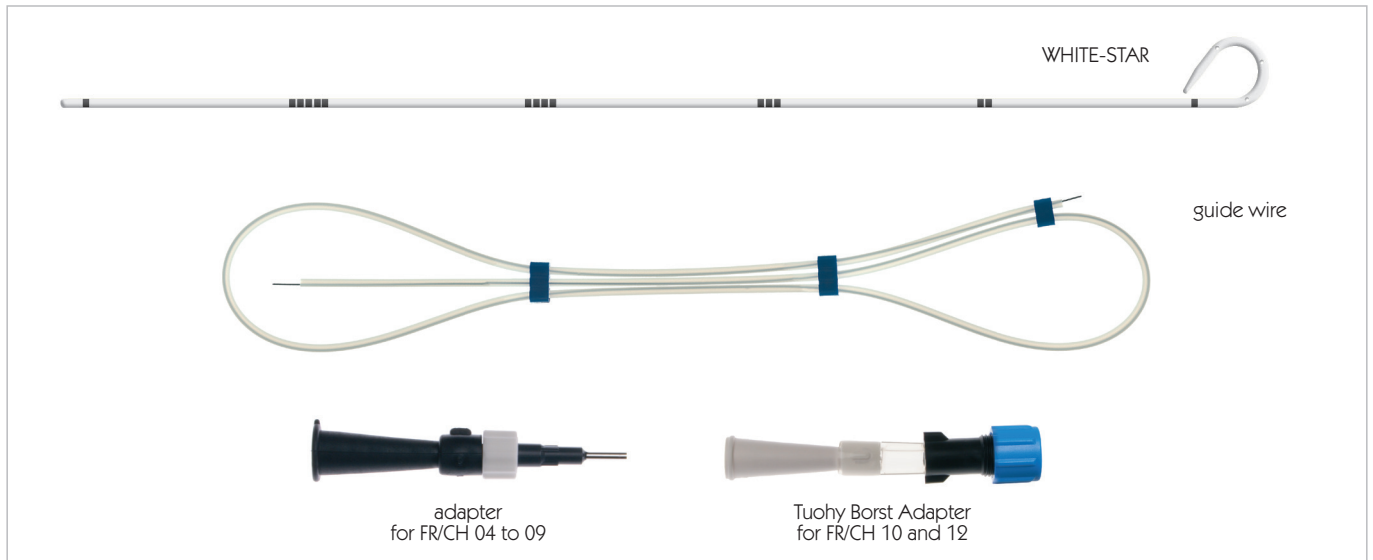

Ureteral Stent

- ◆ Polyurethane (PUR)
- ◆ Drainage openings only in pigtail
- ◆ Open or closed tip
- ◆ Markings for exact positioning
- ◆ Radiopaque

Guide Wire

- ◆ PTFE-coated

Adapter

- ◆ For attachment of the urinary drainage bag

Clamp

- ◆ Only in sets with closed tip



WHITE-STAR MONO Mono-J Ureteral Stent-Set

Open tip						
Size (FR/CH)	Length (cm)	Order Code with Guide Wire	Guide Wire Length (cm)	Guide Wire Diameter	Guide Wire Tip	Guide Wire Stiffness
04	70	EN-350471	125	0.025"	straight	standard
4.7	70	EN-350571	175	0.028"	straight	standard
06	70	EN-350671	175	0.035"	straight	standard
07	70	EN-350771	175	0.035"	straight	standard
08	70	EN-350871	175	0.038"	straight	standard
09	70	EN-350971	175	0.045"	straight	standard
10	70	EN-351071	175	0.045"	straight	standard
12	70	EN-351271	175	0.045"	straight	standard

Closed tip						
Size (FR/CH)	Length (cm)	Order Code with Guide Wire	Guide Wire Length (cm)	Guide Wire Diameter	Guide Wire Tip	Guide Wire Stiffness
04	70	EN-350470	125	0.025"	straight	standard
4.7	70	EN-350570	125	0.028"	straight	standard
06	70	EN-350670	125	0.035"	straight	standard
07	70	EN-350770	125	0.035"	straight	standard
08	70	EN-350870	125	0.035"	straight	standard
09	70	EN-350970	125	0.045"	straight	standard
10	70	EN-351070	125	0.045"	straight	standard
12	70	EN-351270	125	0.045"	straight	standard

URETERAL STENTS

GREEN-STAR

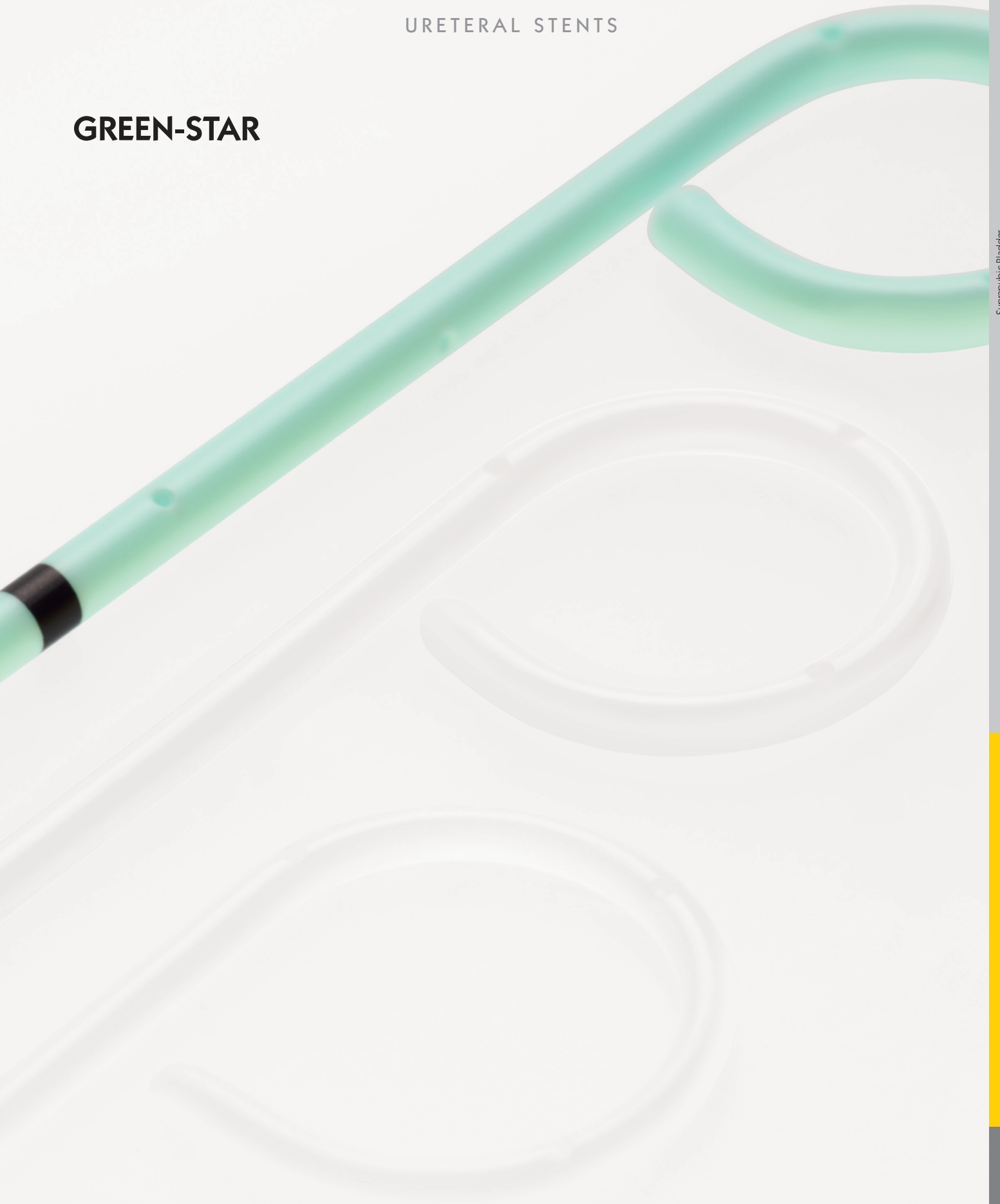

Ureteral Stents

Nephrostomy

Suprapubic Bladder
Drainage

Accessories

Ureteral Catheters

Foley Catheters

Stone Baskets

Urodynamic

Special Products

Care Products

Pediatric Urology



UROTECH

GREEN-STAR Double-J Ureteral Stent-Set

Soft material

SET COMPONENTS

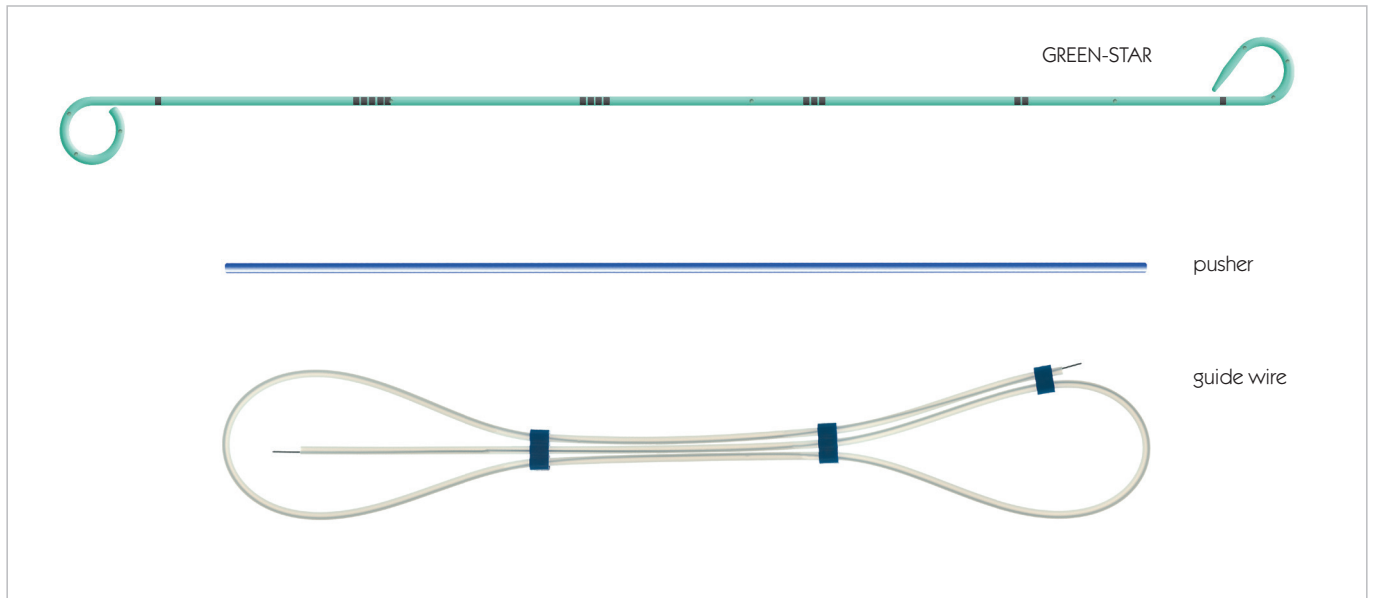

Ureteral Stent

- ◆ Polyurethane (PUR)
- ◆ Special soft material for high patient comfort
- ◆ Drainage openings in pigtails and shaft
- ◆ Open or closed tip
- ◆ Markings for exact positioning
- ◆ High radiopaque visibility

Pusher

- ◆ Length: 40 cm

Guide Wire

- ◆ PTFE-coated

Clamp

- ◆ Only in sets with closed tip



GREEN-STAR Double-J Ureteral Stent-Set

Soft material

Open tip							
Size (FR/CH)	Length (cm)	Order Code without Guide Wire	Order Code with Guide Wire	Guide Wire Length (cm)	Guide Wire Diameter	Guide Wire Tip	Guide Wire Stiffness
06	24	EG-410624	EG-360624	125	0.035"	straight	standard
06	26	EG-410626	EG-360626	125	0.035"	straight	standard
06	28	EG-410628	EG-360628	125	0.035"	straight	standard
06	30	EG-410630	EG-360630	125	0.035"	straight	standard
07	24	EG-410724	EG-360724	125	0.035"	straight	standard
07	26	EG-410726	EG-360726	125	0.035"	straight	standard
07	28	EG-410728	EG-360728	125	0.035"	straight	standard
07	30	EG-410730	EG-360730	125	0.035"	straight	standard
08	24		EG-360824	125	0.035"	straight	standard
08	26	EG-410826	EG-360826	125	0.035"	straight	standard
08	28	EG-410828	EG-360828	125	0.035"	straight	standard
08	30		EG-360830	125	0.035"	straight	standard

Closed tip							
Size (FR/CH)	Length (cm)	Order Code without Guide Wire	Order Code with Guide Wire	Guide Wire Length (cm)	Guide Wire Diameter	Guide Wire Tip	Guide Wire Stiffness
06	24	EG-400624	EG-390624	125	0.035"	straight	standard
06	26	EG-400626	EG-390626	125	0.035"	straight	standard
06	28	EG-400628	EG-390628	125	0.035"	straight	standard
06	30	EG-400630	EG-390630	125	0.035"	straight	standard
07	24		EG-390724	125	0.035"	straight	standard
07	26	EG-400726	EG-390726	125	0.035"	straight	standard
07	28	EG-400728	EG-390728	125	0.035"	straight	standard
07	30	EG-400730	EG-390730	125	0.035"	straight	standard
08	26	EG-400826	EG-390826	125	0.035"	straight	standard
08	28	EG-400828	EG-390828	125	0.035"	straight	standard

GREEN-STAR Double-J Ureteral Stent-Set

Soft material, flexible length

SET COMPONENTS

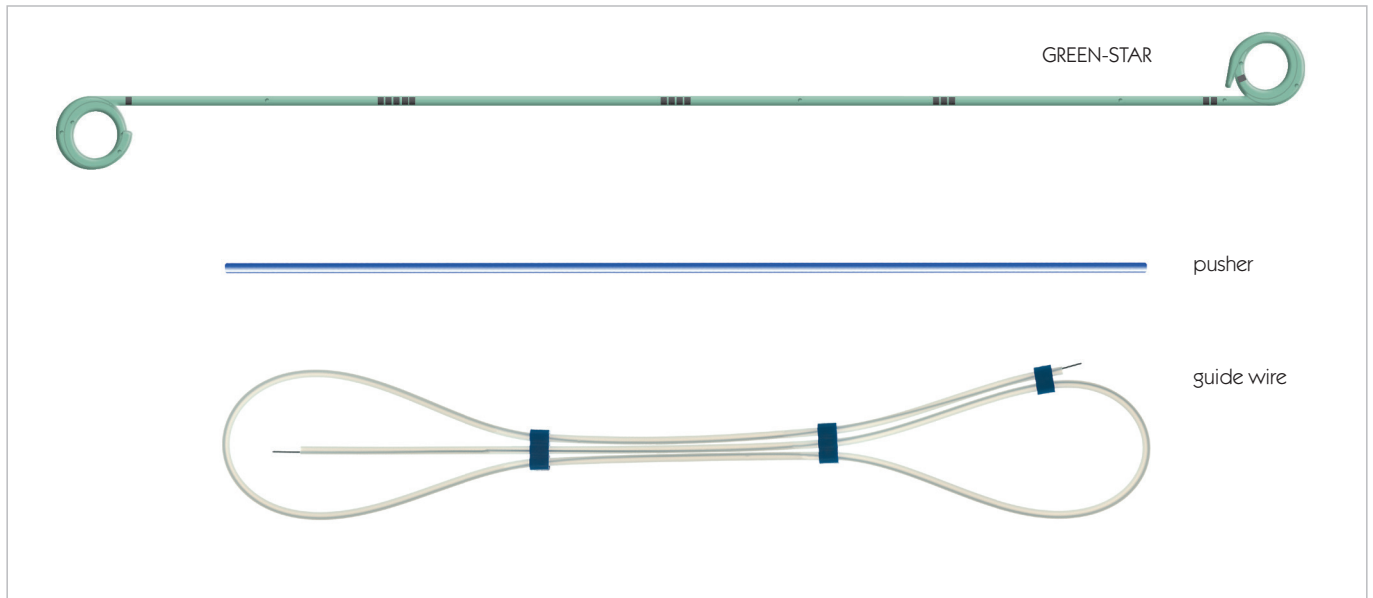

Ureteral Stent

- ◆ Polyurethane (PUR)
- ◆ Special soft material for high patient comfort
- ◆ Multiple coils on both ends for flexible shaft length from 22 to 30 cm
- ◆ Drainage openings in pigtails and shaft
- ◆ Open or closed tip
- ◆ Markings for exact positioning
- ◆ High radiopaque visibility

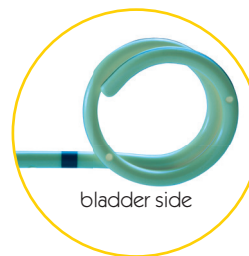

Pusher

- ◆ Length: 40 cm

Guide Wire

- ◆ PTFE-coated

Clamp

- ◆ Only in sets with closed tip



GREEN-STAR Double-J Ureteral Stent-Set

Soft material, flexible length

Open tip							
Size (FR/CH)	Length (cm)	Order Code without Guide Wire	Order Code with Guide Wire	Guide Wire Length (cm)	Guide Wire Diameter	Guide Wire Tip	Guide Wire Stiffness
06	22-30	EG-410622-30-BS	EG-360622-30-BS	125	0.035"	straight	standard
07	22-30	EG-410722-30-BS	EG-360722-30-BS	125	0.035"	straight	standard
08	22-30	EG-410822-30-BS	EG-360822-30-BS	125	0.035"	straight	standard

Closed tip							
Size (FR/CH)	Length (cm)		Order Code with Guide Wire	Guide Wire Length (cm)	Guide Wire Diameter	Guide Wire Tip	Guide Wire Stiffness
06	22-30		EG-390622-30-BS	125	0.035"	straight	standard
07	22-30		EG-390722-30-BS	125	0.035"	straight	standard

GREEN-STAR Double-J Ureteral Stent-Set

Soft material, steerable

SET COMPONENTS

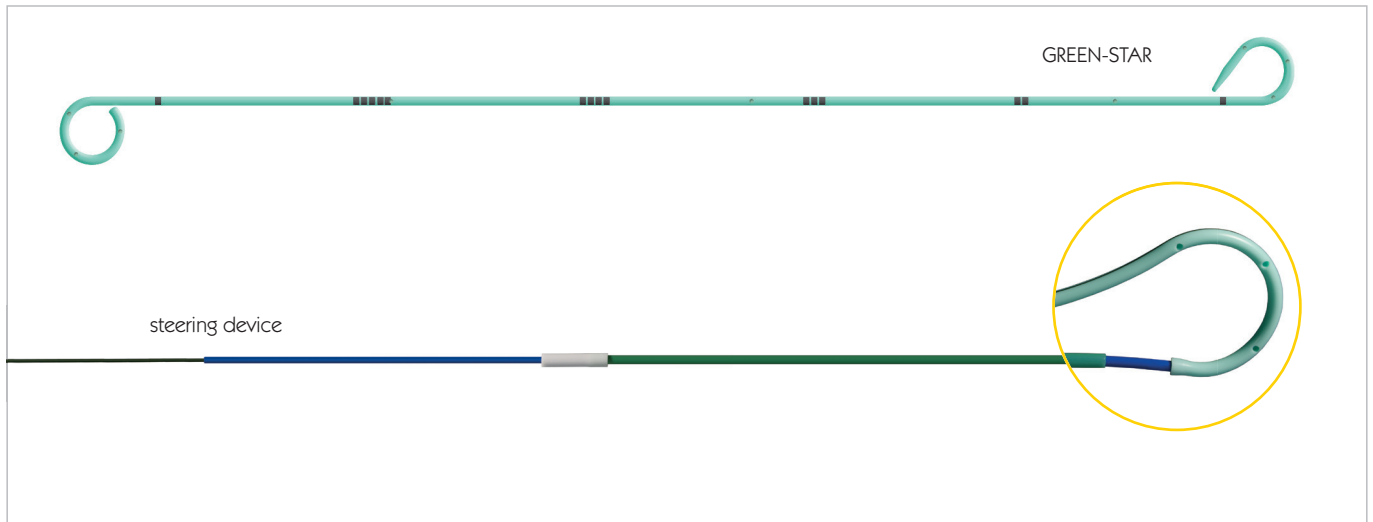

Ureteral Stent

- ◆ Polyurethane (PUR)
- ◆ Special soft material for high patient comfort
- ◆ Drainage openings in pigtails and shaft
- ◆ Open or closed tip
- ◆ Markings for exact positioning
- ◆ High radiopaque visibility

Steering Device

- ◆ Pusher
- ◆ Disconnecter
- ◆ Length: 53 cm

Guide Wire

- ◆ PTFE-coated

Clamp

- ◆ Only in sets with closed tip



GREEN-STAR Double-J Ureteral Stent-Set

Soft material, steerable

Open tip							
Size (FR/CH)	Length (cm)	Order Code without Guide Wire	Order Code with Guide Wire	Guide Wire Length (cm)	Guide Wire Diameter	Guide Wire Tip	Guide Wire Stiffness
06	24	EG-470624	EG-480624	150	0.035"	straight	standard / movable core
06	26	EG-470626	EG-480626	150	0.035"	straight	standard / movable core
06	28	EG-470628	EG-480628	150	0.035"	straight	standard / movable core
06	30	EG-470630	EG-480630	150	0.035"	straight	standard / movable core
07	26	EG-470726	EG-480726	150	0.035"	straight	standard / moveable core
07	28	EG-470728	EG-480728	150	0.035"	straight	standard / moveable core
07	30	EG-470730	EG-480730	150	0.035"	straight	standard / moveable core
08	24		EG-480824	150	0.035"	straight	standard / moveable core
08	26	EG-470826		150	0.035"	straight	standard / moveable core
08	28	EG-470828		150	0.035"	straight	standard / moveable core
08	30	EG-470830	EG-480830	150	0.035"	straight	standard / moveable core

Closed tip							
Size (FR/CH)	Length (cm)		Order Code with Guide Wire	Guide Wire Length (cm)	Guide Wire Diameter	Guide Wire Tip	Guide Wire Stiffness
06	24		EG-490624	125	0.035"	J-tip	standard / movable core
06	26		EG-490626	125	0.035"	J-tip	standard / movable core
06	28		EG-490628	125	0.035"	J-tip	standard / movable core
07	28		EG-490728	125	0.035"	J-tip	standard / movable core
08	26		EG-490826	125	0.035"	J-Tip	standard / movable core
08	28		EG-490828	125	0.035"	J-tip	standard / movable core

GREEN-STAR Double-J Ureteral Stent-Set

Soft material, steerable with coupling

SET COMPONENTS

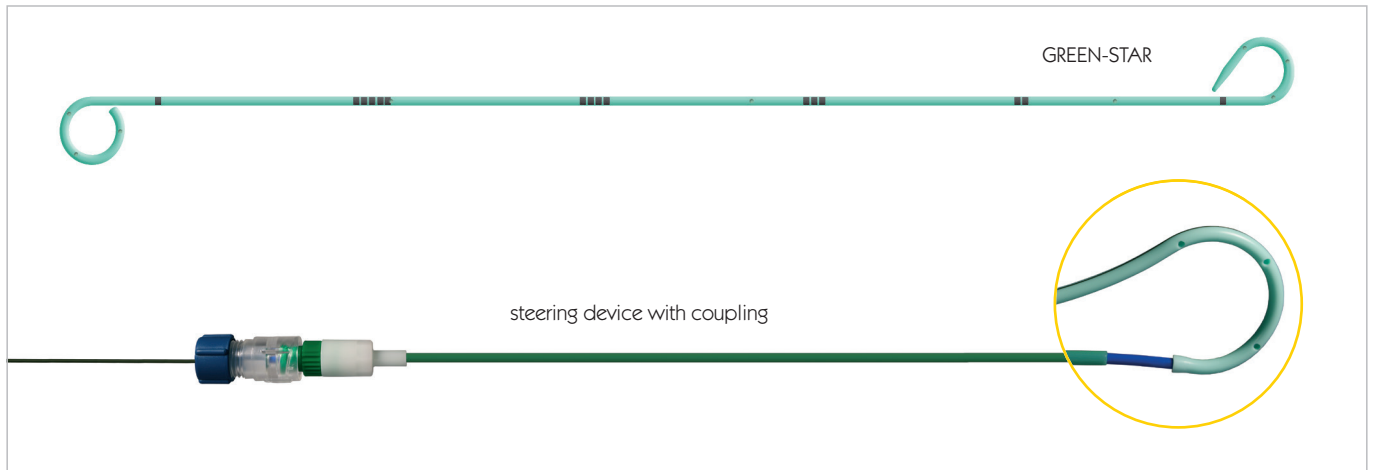

Ureteral Stent

- ◆ Polyurethane (PUR)
- ◆ Special soft material for high patient comfort
- ◆ Drainage openings in pigtails and shaft
- ◆ Open or closed tip
- ◆ Markings for exact positioning
- ◆ High radiopaque visibility

Steering Device with Coupling

- ◆ Pusher
- ◆ Disconnecter
- ◆ Coupling to fasten guide wire
- ◆ Length: 43 cm

Guide Wire

- ◆ PTFE-coated

GREEN-STAR Double-J Ureteral Stent-Set

Soft material, steerable with coupling

Open tip							
Size (FR/CH)	Length (cm)	Order Code without Guide Wire	Order Code with Guide Wire	Guide Wire Length (cm)	Guide Wire Diameter	Guide Wire Tip	Guide Wire Stiffness
06	24	EG-570624	EG-580624	150	0.035"	straight	standard / movable core
06	26	EG-570626	EG-580626	150	0.035"	straight	standard / movable core
06	28	EG-570628	EG-580628	150	0.035"	straight	standard / movable core
06	30		EG-580630	150	0.035"	straight	standard / movable core
07	24	EG-570724	EG-580724	150	0.035"	straight	standard / movable core
07	26	EG-570726	EG-580726	150	0.035"	straight	standard / movable core
07	28	EG-570728	EG-580728	150	0.035"	straight	standard / movable core
07	30	EG-570730	EG-580730	150	0.035"	straight	standard / movable core

Closed tip							
Size (FR/CH)	Length (cm)		Order Code with Guide Wire	Guide Wire Length (cm)	Guide Wire Diameter	Guide Wire Tip	Guide Wire Stiffness
06	24		EG-590624	125	0.035"	J-tip	standard / movable core
06	26		EG-590626	125	0.035"	J-tip	standard / movable core
06	28		EG-590628	125	0.035"	J-tip	standard / movable core
06	30		EG-590630	125	0.035"	J-tip	standard / movable core
07	26		EG-590726	125	0.035"	J-tip	standard / movable core
07	28		EG-590728	125	0.035"	J-tip	standard / movable core
08	24		EG-590824	125	0.035"	J-tip	standard / movable core
08	26		EG-590826	125	0.035"	J-tip	standard / movable core
08	28		EG-590828	125	0.035"	J-tip	standard / movable core

GREEN-STAR MONO Mono-J Ureteral Stent-Set

Soft material

SET COMPONENTS



Ureteral Stent

- ◆ Polyurethane (PUR)
- ◆ Special soft material for high patient comfort
- ◆ Drainage openings only in pigtail
- ◆ Open or closed tip
- ◆ Markings for exact positioning
- ◆ High radiopaque visibility

Guide Wire

- ◆ PTFE-coated

Adapter

- ◆ For attachment of the urinary drainage bag

Clamp

- ◆ Only in sets with closed tip



GREEN-STAR MONO Mono-J Ureteral Stent-Set

Soft material

Open tip						
Size (FR/CH)	Length (cm)	Order Code with Guide Wire	Guide Wire Length (cm)	Guide Wire Diameter	Guide Wire Tip	Guide Wire Stiffness
06	70	EG-350671	175	0.035"	straight	standard
07	70	EG-350771	175	0.035"	straight	standard
08	70	EG-350871	175	0.038"	straight	standard

Closed tip						
Size (FR/CH)	Length (cm)	Order Code with Guide Wire	Guide Wire Length (cm)	Guide Wire Diameter	Guide Wire Tip	Guide Wire Stiffness
06	70	EG-350670	125	0.035"	straight	standard
07	70	EG-350770	125	0.035"	straight	standard
08	70	EG-350870	125	0.035"	straight	standard

SPECIAL STENTS

YELLOW-STAR TUMOR-STENT

WHITE-STAR ESWL

WHITE-STAR INTRAOPERATIVE

WHITE-STAR STENOSIS

URETERAL STENT for supravescical urine drainage

MAGNETIC BLACK-STAR



YELLOW-STAR TUMOR-STENT Double-J Ureteral Stent-Set Treated with PC

SET COMPONENTS

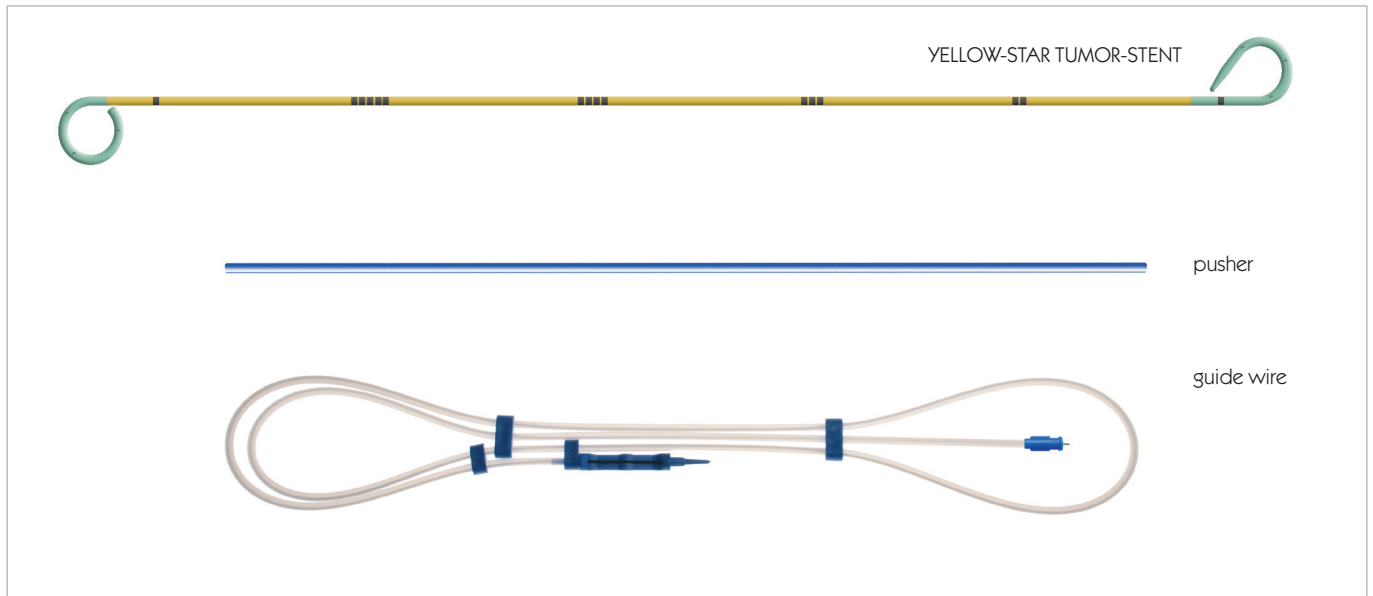

Ureteral Stent

- ◆ Polyurethane (PUR)
- ◆ PC-treatment to minimise risk of infection and encrustation, resulting in extended indwelling time
- ◆ Pressure resistant shaft, without drainage openings for preventing ingrowth of tumor tissue
- ◆ Soft pigtails for better wearing comfort
- ◆ Drainage openings only in pigtails
- ◆ Open tip
- ◆ Markings for exact positioning
- ◆ Radiopaque

Pusher

- ◆ Length: 40 cm

Guide Wire

- ◆ Hydrophilic coating for better gliding ability – prior to application, guide wire must be moistened in dispenser

YELLOW-STAR TUMOR-STENT Double-J Ureteral Stent-Set Treated with PC

Open tip							
Size (FR/CH)	Length (cm)	Order Code without Guide Wire	Order Code with Guide Wire	Guide Wire Length (cm)	Guide Wire Diameter	Guide Wire Tip	Guide Wire Stiffness
06	22	TU-410622	TU-360622	125	0.035"	straight	standard
06	24	TU-410624	TU-360624	125	0.035"	straight	standard
06	26	TU-410626	TU-360626	125	0.035"	straight	standard
06	28	TU-410628	TU-360628	125	0.035"	straight	standard
06	30		TU-360630	125	0.035"	straight	standard
06	32	TU-410632	TU-360632	125	0.035"	straight	standard
07	22	TU-410722	TU-360722	125	0.035"	straight	standard
07	24	TU-410724	TU-360724	125	0.035"	straight	standard
07	26	TU-410726	TU-360726	125	0.035"	straight	standard
07	28	TU-410728	TU-360728	125	0.035"	straight	standard
07	30	TU-410730	TU-360730	125	0.035"	straight	standard
07	32	TU-410732	TU-360732	125	0.035"	straight	standard
08	24	TU-410824	TU-360824	125	0.035"	straight	standard
08	24		TU-360826	125	0.035"	straight	standard
08	26	TU-410828	TU-360828	125	0.035"	straight	standard
08	28	TU-410830	TU-360830	125	0.035"	straight	standard
08	30	TU-410832	TU-360832	125	0.035"	straight	standard

YELLOW-STAR TUMOR-STENT Double-J Ureteral Stent-Set Treated with PC, steerable

SET COMPONENTS

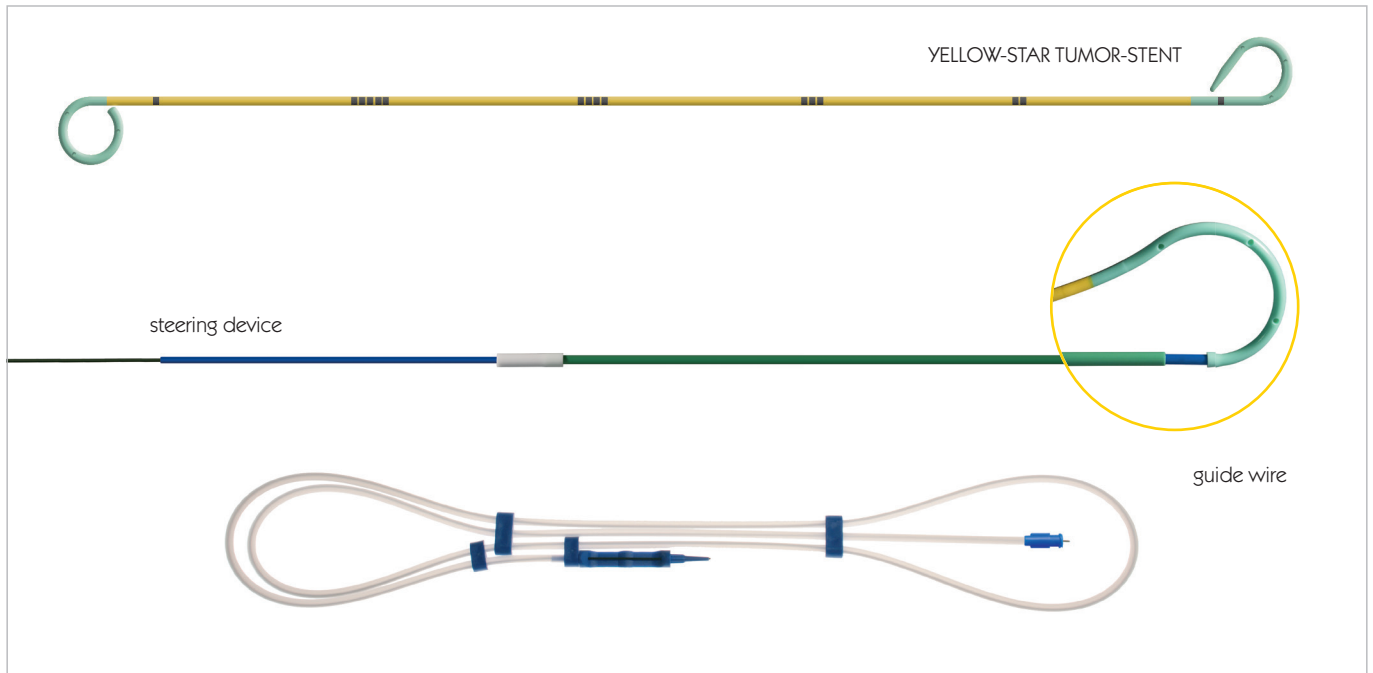

Ureteral Stent

- ◆ Polyurethane (PUR)
- ◆ PC-treatment to minimise risk of infection and encrustation, resulting in extended indwelling time
- ◆ Pressure resistant shaft, without drainage openings for preventing ingrowth of tumor tissue
- ◆ Soft pigtails for better wearing comfort
- ◆ Drainage openings only in pigtails
- ◆ Open tip
- ◆ Markings for exact positioning
- ◆ Radiopaque

Steering Device

- ◆ Pusher
- ◆ Disconnecter
- ◆ Length: 53 cm

Guide Wire

- ◆ Hydrophilic coating for better gliding ability – prior to application, guide wire must be moistened in dispenser

YELLOW-STAR TUMOR-STENT Double-J Ureteral Stent-Set

Treated with PC, steerable

Open tip							
Size (FR/CH)	Length (cm)	Order Code without Guide Wire	Order Code with Guide Wire	Guide Wire Length (cm)	Guide Wire Diameter	Guide Wire Tip	Guide Wire Stiffness
06	22		TU-480622	150	0.035"	straight	standard
06	26		TU-480626	150	0.035"	straight	standard
06	28		TU-480628	150	0.035"	straight	standard
06	30		TU-480630	150	0.035"	straight	standard
07	24	TU-470724	TU-480724	150	0.035"	straight	standard
07	26	TU-470726	TU-480726	150	0.035"	straight	standard
07	28	TU-470728	TU-480728	150	0.035"	straight	standard
07	30	TU-470730	TU-480730	150	0.035"	straight	standard
07	32		TU-480732	150	0.035"	straight	standard
08	24	TU-470824		150	0.035"	straight	standard
08	26		TU-480826	150	0.035"	straight	standard
08	28	TU-470828	TU-480828	150	0.035"	straight	standard

YELLOW-STAR TUMOR-STENT Double-J Ureteral Stent-Set Treated with PC, steerable with coupling

SET COMPONENTS

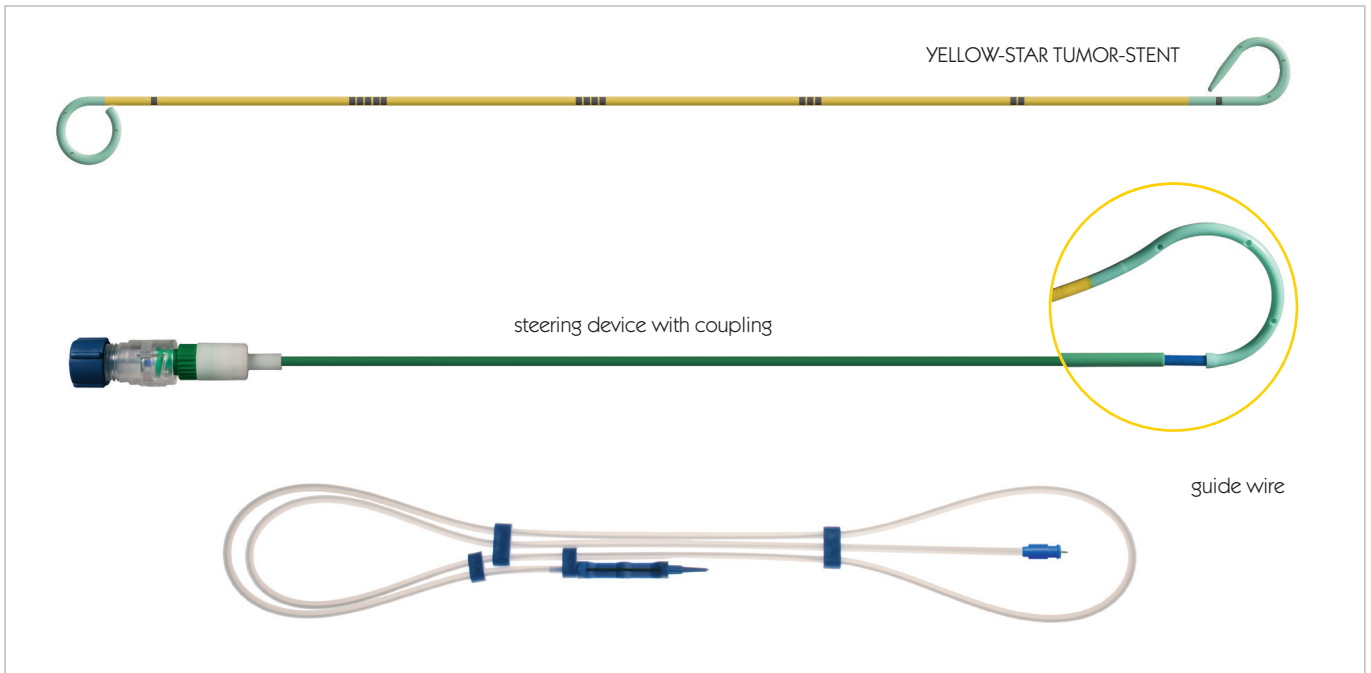

Ureteral Stent

- ◆ Polyurethane (PUR)
- ◆ PC-treatment to minimise risk of infection and encrustation, resulting in extended indwelling time
- ◆ Pressure resistant shaft, without drainage openings for preventing ingrowth of tumor tissue
- ◆ Soft pigtails for better wearing comfort
- ◆ Drainage openings only in pigtails
- ◆ Open tip
- ◆ Markings for exact positioning
- ◆ Radiopaque

Steering Device with Coupling

- ◆ Pusher
- ◆ Disconnecter
- ◆ Coupling to fasten guide wire
- ◆ Length: 43 cm

Guide Wire

- ◆ Hydrophilic coating for better gliding ability – prior to application, guide wire must be moistened in dispenser

YELLOW-STAR TUMOR-STENT Double-J Ureteral Stent-Set

Treated with PC, steerable with coupling

Open tip							
Size (FR/CH)	Length (cm)	Order Code without Guide Wire	Order Code with Guide Wire	Guide Wire Length (cm)	Guide Wire Diameter	Guide Wire Tip	Guide Wire Stiffness
06	24	TU-570624		150	0.035"	straight	standard
06	26	TU-570626		150	0.035"	straight	standard
06	28	TU-570628		150	0.035"	straight	standard
06	30	TU-570630		150	0.035"	straight	standard
07	24	TU-570724	TU-580724	150	0.035"	straight	standard
07	26	TU-570726	TU-580726	150	0.035"	straight	standard
07	28	TU-570728	TU-580728	150	0.035"	straight	standard
07	30	TU-570730	TU-580730	150	0.035"	straight	standard
08	24		TU-580824	150	0.035"	straight	standard
08	26	TU-570826	TU-580826	150	0.035"	straight	standard
08	28	TU-570828	TU-580828	150	0.035"	straight	standard
08	30	TU-570830	TU-580830	150	0.035"	straight	standard

WHITE-STAR ESWL Double-J Ureteral Stent-Set

With special profile

SET COMPONENTS

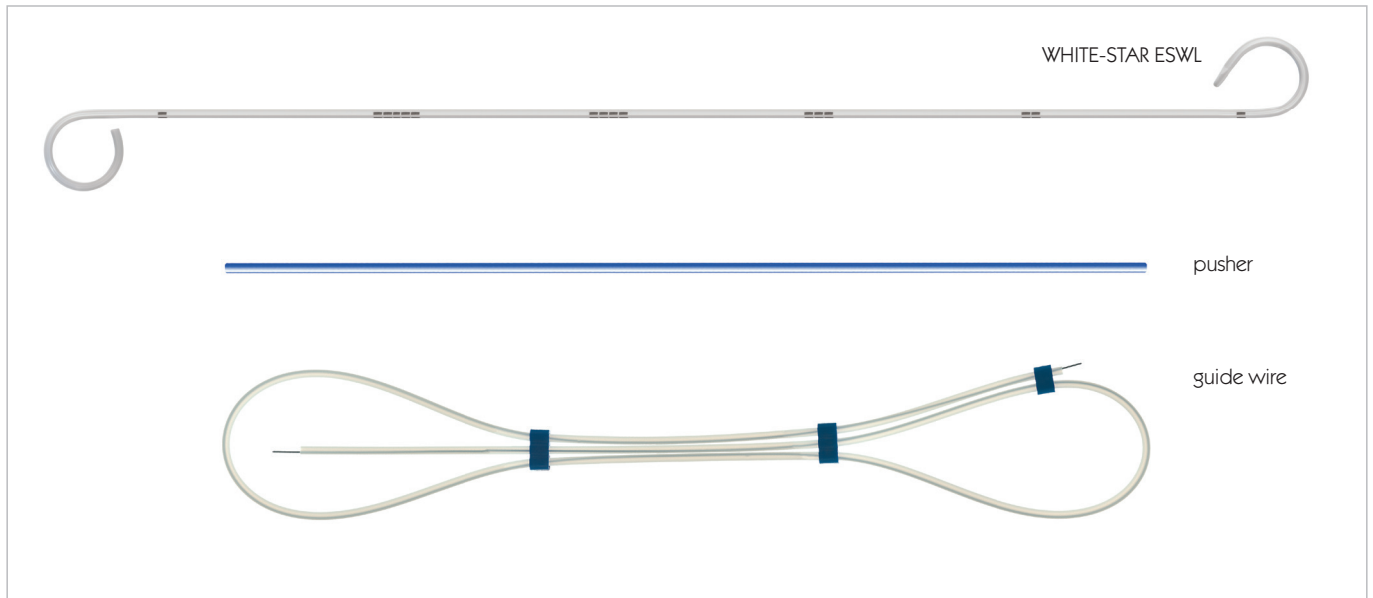

Ureteral Stent

- ◆ Polyurethane (PUR)
- ◆ With special profile for supporting transport of stone debris
- ◆ Drainage openings only in pigtails
- ◆ Open or closed tip
- ◆ Markings for exact positioning
- ◆ Radiopaque

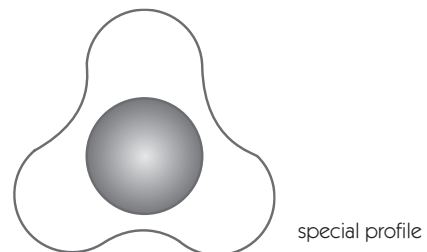

Pusher

- ◆ Length: 40 cm

Guide Wire

- ◆ PTFE-coated

Clamp

- ◆ Only in sets with closed tip



WHITE-STAR ESWL Double-J Ureteral Stent-Set With special profile

Open tip							
Size (FR/CH)	Length (cm)	Order Code without Guide Wire	Order Code with Guide Wire	Guide Wire Length (cm)	Guide Wire Diameter	Guide Wire Tip	Guide Wire Stiffness
07	24	EL-410724	EL-360724	125	0.035"	straight	standard
07	26	EL-410726	EL-360726	125	0.035"	straight	standard
07	28	EL-410728	EL-360728	125	0.035"	straight	standard
07	30	EL-410730	EL-360730	125	0.035"	straight	standard

Closed tip							
Size (FR/CH)	Length (cm)		Order Code with Guide Wire	Guide Wire Length (cm)	Guide Wire Diameter	Guide Wire Tip	Guide Wire Stiffness
07	24		EL-390724	125	0.035"	straight	standard
07	26		EL-390726	125	0.035"	straight	standard
07	28		EL-390728	125	0.035"	straight	standard
07	30		EL-390730	125	0.035"	straight	standard

WHITE-STAR INTRAOPERATIVE Double-J Ureteral Stent-Set

Round tip

SET COMPONENTS

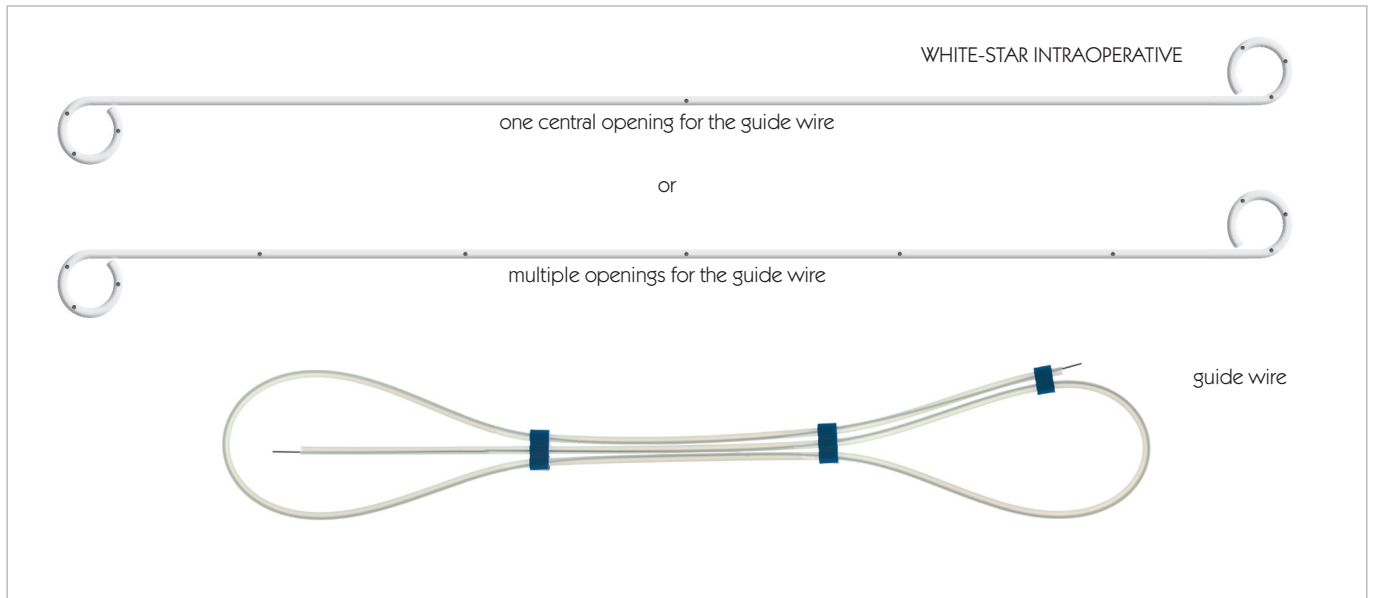

Ureteral Stent

- ◆ Polyurethane (PUR)
- ◆ Both ends closed
- ◆ At the shaft one central opening or multiple openings for the guide wire
- ◆ Radiopaque

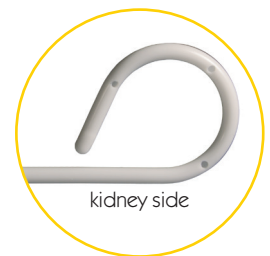
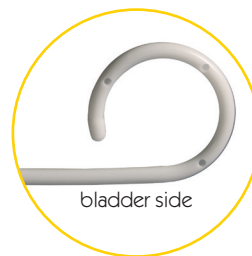

Guide Wire

- ◆ PTFE-coated

WHITE-STAR INTRAOPERATIVE Double-J Ureteral Stent-Set

Round tip

One central opening for the guide wire – closed tip

Size (FR/CH)	Length (cm)	Order Code with Guide Wire	Guide Wire Length (cm)	Guide Wire Diameter	Guide Wire Tip	Guide Wire Stiffness
4.7	24	EN-320524	100	0.028"	straight	standard
4.7	26	EN-320526	100	0.028"	straight	standard
4.7	28	EN-320528	100	0.028"	straight	standard
4.7	30	EN-320530	100	0.028"	straight	standard
06	24	EN-320624	100	0.035"	straight	standard
06	26	EN-320626	100	0.035"	straight	standard
06	28	EN-320628	100	0.035"	straight	standard
06	30	EN-320630	100	0.035"	straight	standard
07	24	EN-320724	100	0.035"	straight	standard
07	26	EN-320726	100	0.035"	straight	standard
07	28	EN-320728	100	0.035"	straight	standard
07	30	EN-320730	100	0.035"	straight	standard

Multiple openings for the guide wire – closed tip

Size (FR/CH)	Length (cm)	Order Code with Guide Wire	Guide Wire Length (cm)	Guide Wire Diameter	Guide Wire Tip	Guide Wire Stiffness
4.7	24	EN-330524	100	0.028"	straight	standard
4.7	26	EN-330526	100	0.028"	straight	standard
4.7	28	EN-330528	100	0.028"	straight	standard
4.7	30	EN-330530	100	0.028"	straight	standard
06	24	EN-330624	100	0.035"	straight	standard
06	26	EN-330626	100	0.035"	straight	standard
06	28	EN-330628	100	0.035"	straight	standard
06	30	EN-330630	100	0.035"	straight	standard
07	24	EN-330724	100	0.035"	straight	standard
07	26	EN-330726	100	0.035"	straight	standard
07	28	EN-330728	100	0.035"	straight	standard
07	30	EN-330730	100	0.035"	straight	standard

WHITE-STAR STENOSIS Stenosis Stent-Set

Partial shaft enlargement

SET COMPONENTS

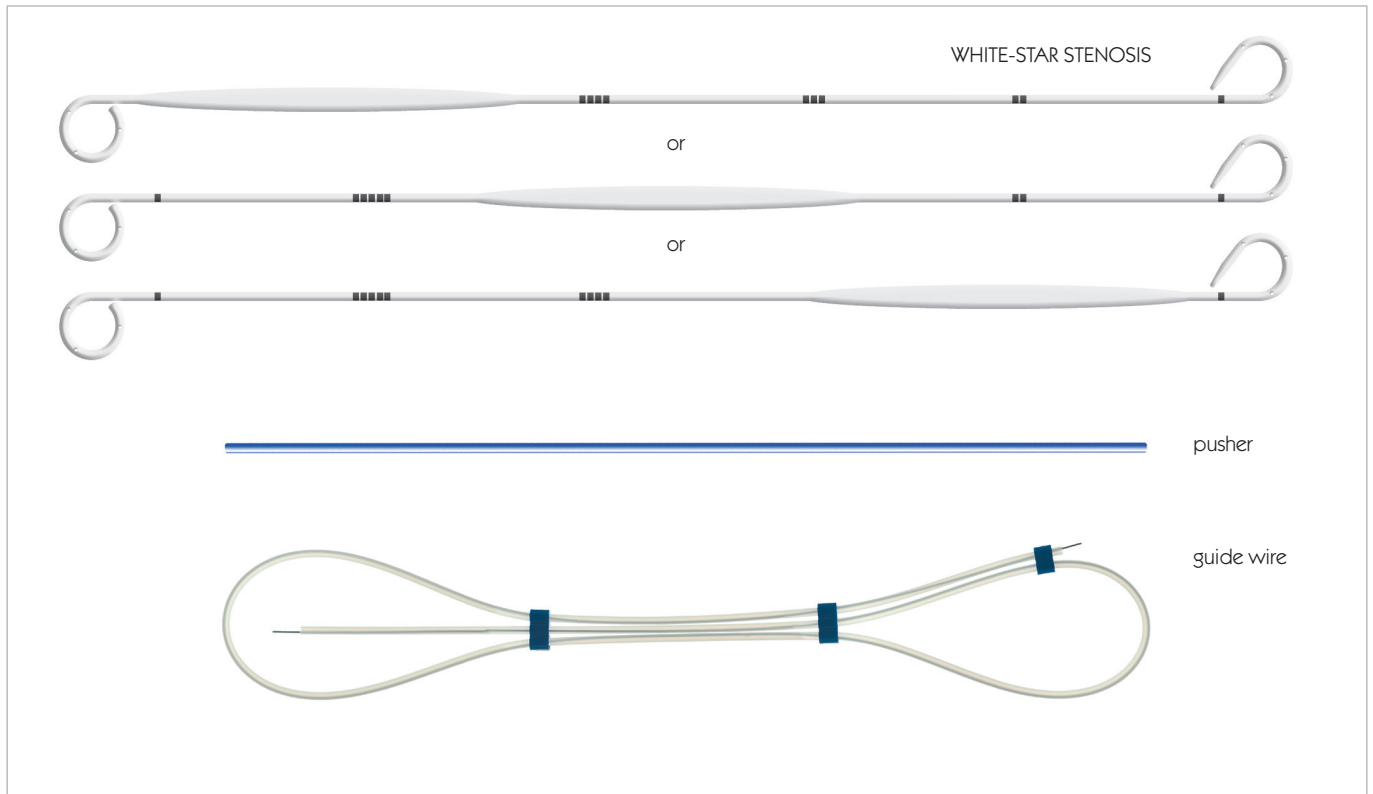

Ureteral Stent

- ◆ Polyurethane (PUR)
- ◆ Drainage openings only in pigtails
- ◆ Open tip
- ◆ Markings for exact positioning
- ◆ Radiopaque
- ◆ Partial enlargement (kidney, central, bladder) for dilation of stenosis

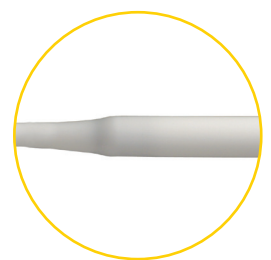

Pusher

- ◆ Length: 40 cm

Guide Wire

- ◆ PTFE-coated

WHITE-STAR STENOSIS Stenosis Stent-Set

Partial shaft enlargement

Bladder side – open tip

Size (FR/CH)	Shaft Enlargement (FR/CH)	Length (cm)	Order Code with Guide Wire	Guide Wire Length (cm)	Guide Wire Diameter	Guide Wire Tip	Guide Wire Stiffness
07	12	26	TU-201226-P	125	0.035"	straight	standard
07	12	28	TU-201228-P	125	0.035"	straight	standard
07	12	30	TU-201230-P	125	0.035"	straight	standard

Central enlargement – open tip

Size (FR/CH)	Shaft Enlargement (FR/CH)	Length (cm)	Order Code with Guide Wire	Guide Wire Length (cm)	Guide Wire Diameter	Guide Wire Tip	Guide Wire Stiffness
07	12	26	TU-201226-M	125	0.035"	straight	standard
07	12	28	TU-201228-M	125	0.035"	straight	standard
07	12	30	TU-201230-M	125	0.035"	straight	standard

Kidney side – open tip

Size (FR/CH)	Shaft Enlargement (FR/CH)	Length (cm)	Order Code with Guide Wire	Guide Wire Length (cm)	Guide Wire Diameter	Guide Wire Tip	Guide Wire Stiffness
07	12	26	TU-201226-D	125	0.035"	straight	standard
07	12	28	TU-201228-D	125	0.035"	straight	standard
07	12	30	TU-201230-D	125	0.035"	straight	standard

URETERAL STENT-SET for supravvesical urine drainage

SET COMPONENTS

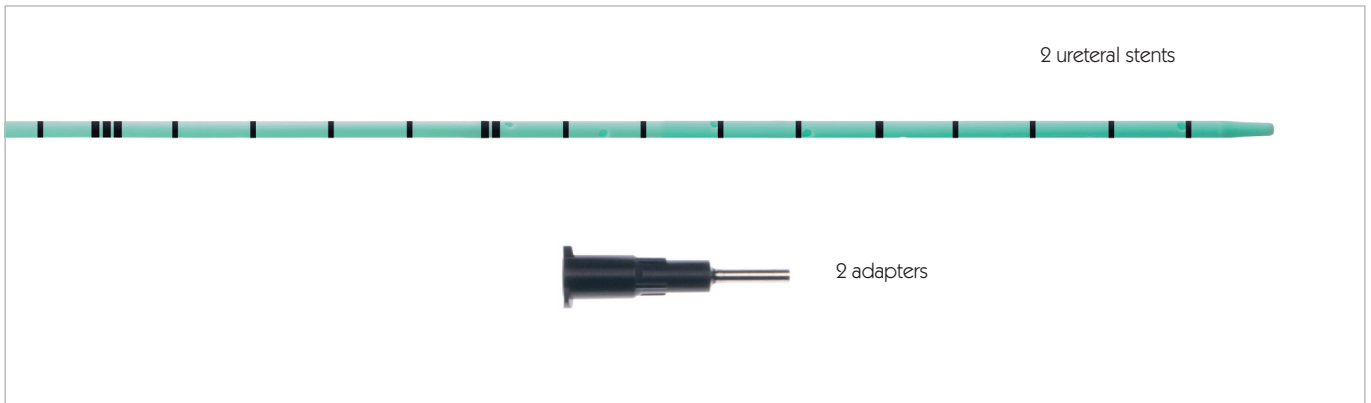

Ureteral Stent

- ◆ Polyurethane (PUR)
- ◆ 8 drainage openings at distal end for constant urine flow
- ◆ Open tip
- ◆ Markings for exact positioning
- ◆ Radiopaque
- ◆ Application e.g. after neobladder reconstruction surgery



Adapter

- ◆ Cannula adapter for drainage or attachment of the urinary drainage bag (Luer Connector)

Open tip					
Size (FR/CH)	Length (cm)	Material-Typ		Order Code without Guide Wire	Max. Guide Wire Diameter
4.7	70	White-Star	○	WEB-120570-NEO	0.028"
06	70	Green-Star	●	WEB-120670-NEO	0.035"
08	70	Green-Star	●	WEB-120870-NEO	0.035"

MAGNETIC BLACK-STAR Double-J Ureteral Stent-Set and Retrieval Device with magnet

SET COMPONENTS

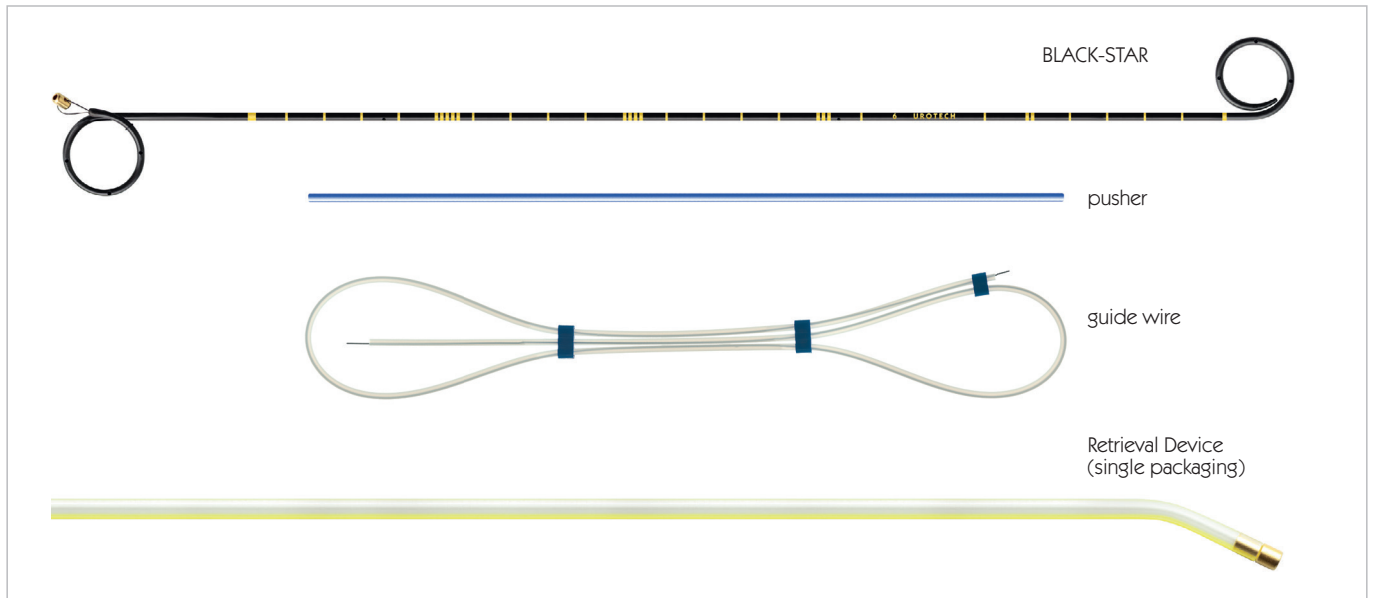

Ureteral Stent

- ◆ Polyurethane (PUR)
- ◆ Drainage openings in pigtails and shaft
- ◆ Open tip
- ◆ Markings for exact positioning
- ◆ Radiopaque
- ◆ Magnet at bladder side



Pusher

- ◆ Length: 40 cm

Guide Wire

- ◆ PTFE-coated

Retrieval Device with magnet

- ◆ Soft PUR
- ◆ Easy tip orientation via marking line
- ◆ Tiemann tip, 30°
- ◆ Single packaging

MAGNETIC BLACK-STAR Double-J Ureteral Stent-Set and Retrieval Device with magnet

Open tip								
Size (FR/CH)	Length (cm)	Size Magnet of the Stent (FR/CH)	Order Code without Guide Wire with Retrieval Device	Order Code with Guide Wire with Retrieval Device	Guide Wire Length (cm)	Guide Wire Diameter	Guide Wire Tip	Guide Wire Stiffness
4.8	20	07	MR-414820	MR-364820	150	0.028"	straight	standard
4.8	22	07	MR-414822	MR-364822	150	0.028"	straight	standard
4.8	24	07	MR-414824	MR-364824	150	0.028"	straight	standard
4.8	26	07	MR-414826	MR-364826	150	0.028"	straight	standard
06	15	09	MR-410615	MR-360615	150	0.035"	straight	standard
06	18	09	MR-410618	MR-360618	150	0.035"	straight	standard
06	20	09	MR-414820	MR-364820	150	0.035"	straight	standard
06	22	09	MR-410622	MR-360622	150	0.035"	straight	standard
06	24	09	MR-410624	MR-360624	150	0.035"	straight	standard
06	26	09	MR-410626	MR-360626	150	0.035"	straight	standard
07	15	09	MR-410715	MR-360715	150	0.035"	straight	standard
07	18	09	MR-410718	MR-360718	150	0.035"	straight	standard
07	20	09	MR-410720	MR-360720	150	0.035"	straight	standard
07	22	09	MR-410722	MR-360722	150	0.035"	straight	standard
07	24	09	MR-410724	MR-360724	150	0.035"	straight	standard
07	26	09	MR-410726	MR-360726	150	0.035"	straight	standard

Offene Spitze ohne Retrieval Device								
Size (FR/CH)		Size Magnet of the Stent (FR/CH)	Order Code without Guide Wire without Retrieval Device	Order Code with Guide Wire without Retrieval Device	Guide Wire Length (cm)	Guide Wire Diameter	Guide Wire Tip	Guide Wire Stiffness
4.8	20	07	MR-404820	MR-304820	150	0.028"	straight	standard
4.8	22	07	MR-404822	MR-304822	150	0.028"	straight	standard
4.8	24	07	MR-404824	MR-304824	150	0.028"	straight	standard
4.8	26	07	MR-404826	MR-304826	150	0.028"	straight	standard
06	15	09	MR-400615	MR-300615	150	0.035"	straight	standard
06	18	09	MR-400618	MR-300618	150	0.035"	straight	standard
06	20	09	MR-400620	MR-300620	150	0.035"	straight	standard
06	22	09	MR-400622	MR-300622	150	0.035"	straight	standard
06	24	09	MR-400624	MR-300624	150	0.035"	straight	standard
06	26	09	MR-400626	MR-300626	150	0.035"	straight	standard
07	15	09	MR-400715	MR-300715	150	0.035"	straight	standard
07	18	09	MR-400718	MR-300718	150	0.035"	straight	standard
07	20	09	MR-400720	MR-300720	150	0.035"	straight	standard
07	22	09	MR-400722	MR-300722	150	0.035"	straight	standard
07	24	09	MR-400724	MR-300724	150	0.035"	straight	standard
07	26	09	MR-400726	MR-300726	150	0.035"	straight	standard

Retrieval Device			
Size (FR/CH)	Length (cm)	Order Code suitable for FR/CH 4.8	Order Code suitable for FR/CH 6/7
09	40	R-Device-S	-
15	40	-	R-Device-L

NEPHROSTOMY



Nephrostomy

Suprapubic Bladder
Drainage

Accessories

Ureteral Catheters

Foley Catheters

Stone Baskets

Urodynamic

Special Products

Care Products

Pediatric Urology



UROTECH

RENODRAIN-YELLOW Nephrostomy Puncture- and Exchange Set

Seldinger technique, Treated with PC, with pigtail

SET COMPONENTS

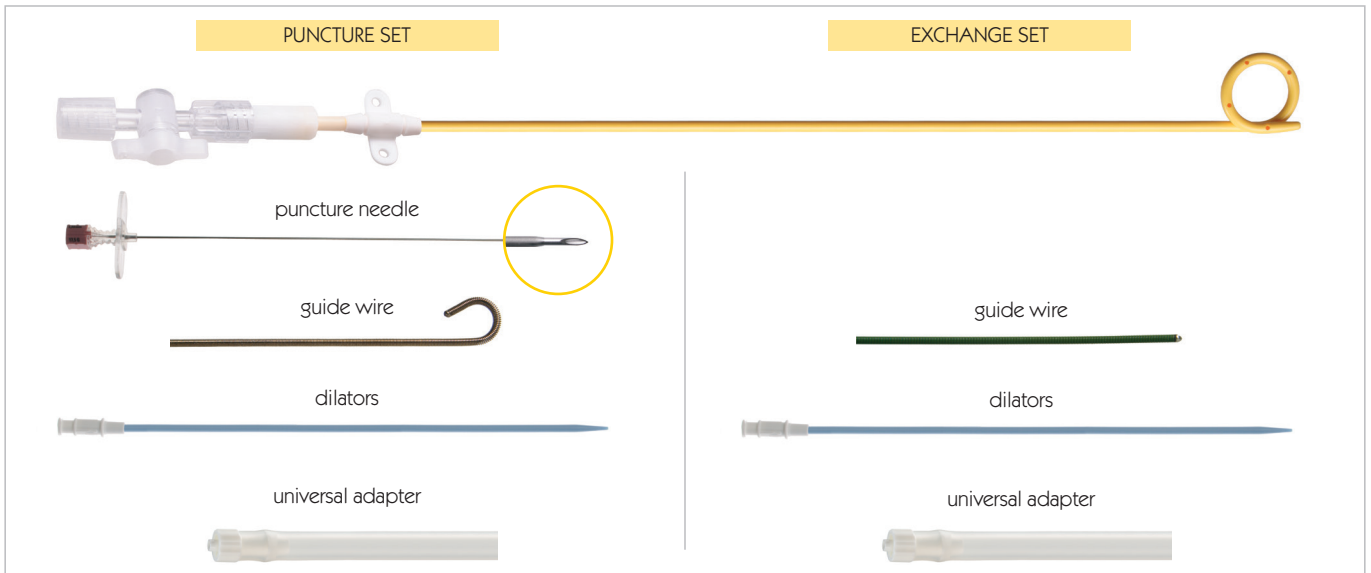

Nephrostomy Catheter

- ◆ Polyurethane (PUR)
- ◆ Treated with PC to minimise the risk of infection and encrustation, therefore extended indwelling time
- ◆ Drainage openings in pigtail
- ◆ Luer Lock Connector



Puncture Needle

- ◆ 2-part needle
- ◆ Medical stainless steel
- ◆ 18 G, length: 20 cm
- ◆ Ultrasonic visible

Guide Wire (Lunderquist)

- ◆ PTFE-coated

Universal Adapter

- ◆ Male Adapter with Luer Lock Connector
- ◆ 10 cm Silicone tube

RENODRAIN-YELLOW Nephrostomy Puncture- and Exchange Set

Seldinger technique, Treated with PC, with pigtail

Single Catheter		
Size (FR/CH)	Length (cm)	Order Code Pigtail Catheter
06	24	RP-410640
06	34	RP-410650
07	24	RP-410740
07	34	RP-410750
08	24	RP-410840
08	34	RP-410850
09	24	RP-410940
09	34	RP-410950
10.5	30	RP-411050
12	30	RP-411250
14	28	RP-411440

Puncture Set							
Size (FR/CH)	Length (cm)	Order Code Puncture Set	Dilators (FR/CH)	Guide Wire Length (cm)	Guide Wire Diameter	Guide Wire Tip (r=1.5 mm)	Guide Wire Stiffness
06	24	RP-400640	05/07	80	0.035"	J-Tip	stiff
06	34	RP-400650	05/07	80	0.035"	J-Tip	stiff
07	24	RP-400740	06/08	80	0.035"	J-Tip	stiff
07	34	RP-400750	06/08	80	0.035"	J-Tip	stiff
08	24	RP-400840	07/09	80	0.035"	J-Tip	stiff
08	34	RP-400850	07/09	80	0.035"	J-Tip	stiff
09	24	RP-400940	08/10	80	0.035"	J-Tip	stiff
09	34	RP-400950	08/10	80	0.035"	J-Tip	stiff
10.5	30	RP-401050	08/12	80	0.035"	J-Tip	stiff
12	30	RP-401250	10/14	80	0.035"	J-Tip	stiff
14	28	RP-401440	10/14/16	80	0.035"	J-Tip	stiff

Exchange Set							
Size (FR/CH)	Length (cm)	Order Code Exchange Set	Dilators (FR/CH)	Guide Wire Length (cm)	Guide Wire Diameter	Guide Wire Tip	Guide Wire Stiffness
06	24	RP-400642	06/07	80	0.035"	straight	stiff
06	34	RP-400652	06/07	80	0.035"	straight	stiff
07	24	RP-400742	07/08	80	0.035"	straight	stiff
07	34	RP-400752	07/08	80	0.035"	straight	stiff
08	24	RP-400842	08/09	80	0.035"	straight	stiff
08	34	RP-400852	08/09	80	0.035"	straight	stiff
09	24	RP-400942	09/10	80	0.035"	straight	stiff
09	34	RP-400952	09/10	80	0.035"	straight	stiff
10.5	30	RP-401052	10/12	80	0.035"	straight	stiff
12	30	RP-401252	12/14	80	0.035"	straight	stiff
14	28	RP-401442	12/14/16	80	0.035"	straight	stiff

RENODRAIN Nephrostomy Puncture- and Exchange Set

Seldinger technique, with pigtail

SET COMPONENTS

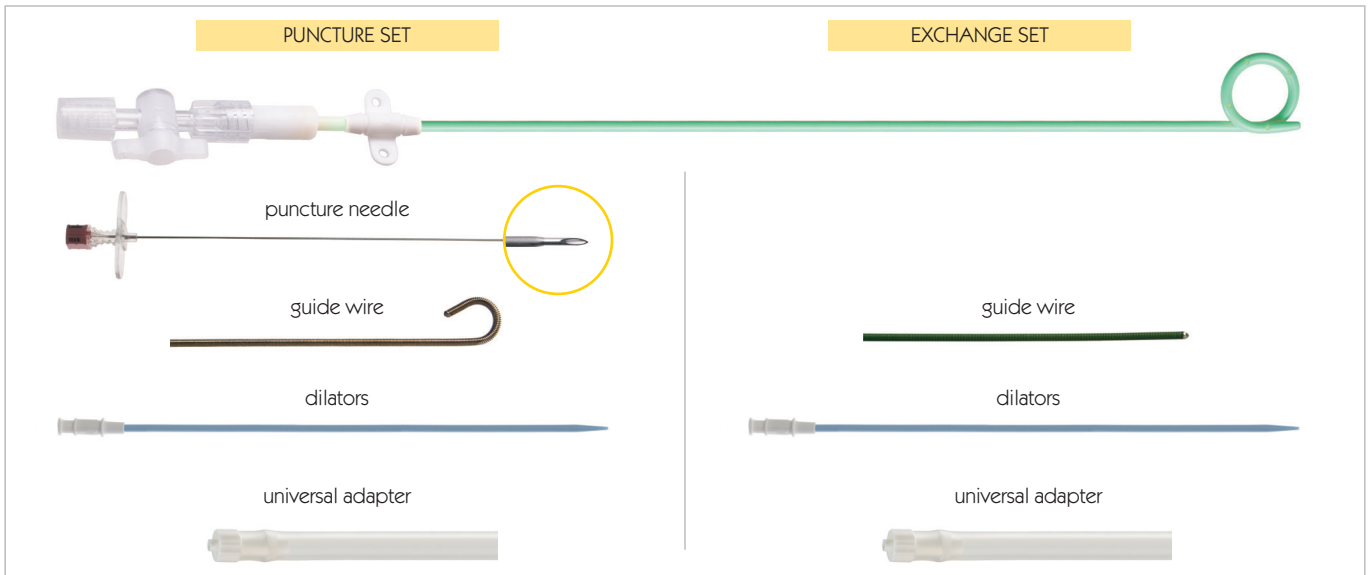

Nephrostomy Catheter

- ◆ Polyurethane (PUR)
- ◆ Drainage openings in pigtail
- ◆ Luer Lock Connector

Puncture Needle

- ◆ 2-part needle
- ◆ Medical stainless steel
- ◆ 18 G, length: 20 cm
- ◆ Ultrasonic visible

Guide Wire (Lunderquist)

- ◆ PTFE-coated

Universal Adapter

- ◆ Male Adapter with Luer Lock Connector
- ◆ 10 cm Silicone tube

RENODRAIN Nephrostomy Puncture- and Exchange Set

Seldinger technique, with pigtail

Single Catheter		
Size (FR/CH)	Length (cm)	Order Code Pigtail Catheter
06	24	RE-410640
06	34	RE-410650
07	24	RE-410740
07	34	RE-410750
08	24	RE-410840
08	34	RE-410850
09	24	RE-410940
09	34	RE-410950
10.5	30	RE-411050
12	30	RE-411250
14	28	RE-411440

Puncture Set							
Size (FR/CH)	Length (cm)	Order Code Puncture Set	Dilators (FR/CH)	Guide Wire Length (cm)	Guide Wire Diameter	Guide Wire Tip (r=1.5 mm)	Guide Wire Stiffness
06	24	RC-400640	07	80	0.035"	J-Tip	stiff
06	34	RC-400650	07	80	0.035"	J-Tip	stiff
07	24	RC-400740	08	80	0.035"	J-Tip	stiff
07	34	RC-400750	08	80	0.035"	J-Tip	stiff
08	24	RC-400840	09	80	0.035"	J-Tip	stiff
08	34	RC-400850	09	80	0.035"	J-Tip	stiff
09	24	RC-400940	10	80	0.035"	J-Tip	stiff
09	34	RC-400950	10	80	0.035"	J-Tip	stiff
10.5	30	RC-401050	08/12	80	0.035"	J-Tip	stiff
12	30	RC-401250	10/14	80	0.035"	J-Tip	stiff
14	28	RC-401440	10/16	80	0.035"	J-Tip	stiff

Exchange Set							
Size (FR/CH)	Length (cm)	Order Code Exchange Set	Dilators (FR/CH)	Guide Wire Length (cm)	Guide Wire Diameter	Guide Wire Tip	Guide Wire Stiffness
06	24	RC-400642	06/07	80	0.035"	straight	stiff
06	34	RC-400652	06/07	80	0.035"	straight	stiff
07	24	RC-400742	07/08	80	0.035"	straight	stiff
07	34	RC-400752	07/08	80	0.035"	straight	stiff
08	24	RC-400842	08/09	80	0.035"	straight	stiff
08	34	RC-400852	08/09	80	0.035"	straight	stiff
09	24	RC-400942	09/10	80	0.035"	straight	stiff
09	34	RC-400952	09/10	80	0.035"	straight	stiff
10.5	30	RC-401052	10/12	80	0.035"	straight	stiff
12	30	RC-401252	12/14	80	0.035"	straight	stiff
14	28	RC-401449	14/16	80	0.035"	straight	stiff

MAGNUSSON LOCKING SYSTEM Nephrostomy Puncture-/Exchange Set

Seldinger technique, Treated with PC, with pigtail, with locking system

SET COMPONENTS

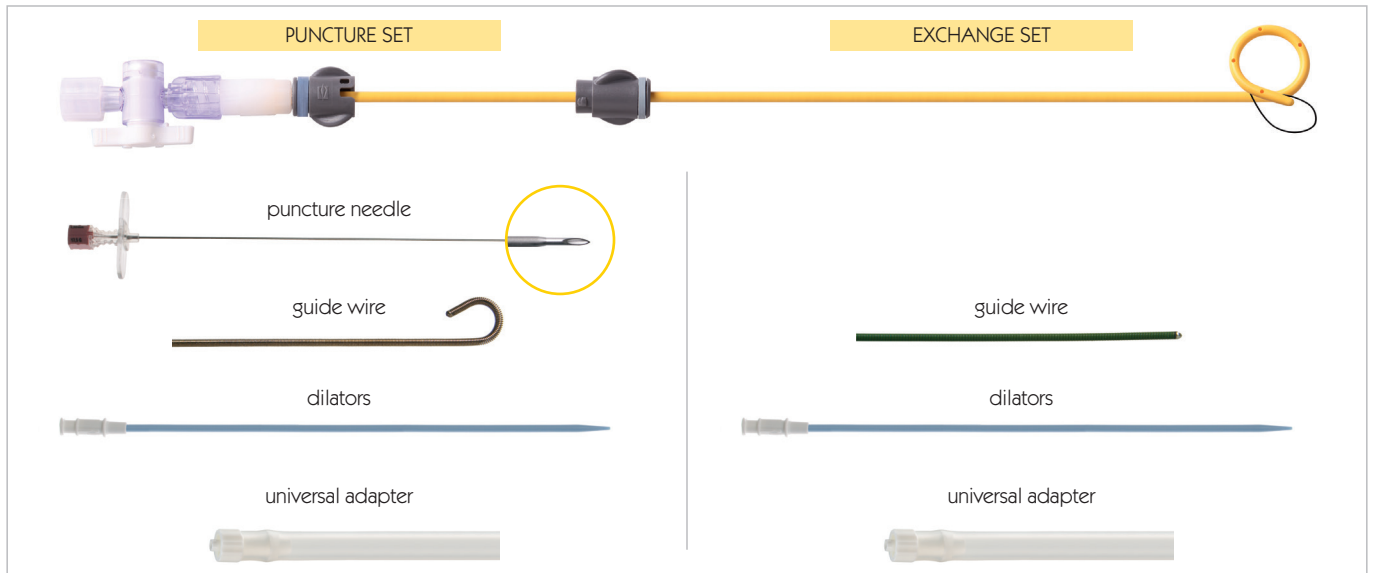

Nephrostomy Catheter

- ◆ Polyurethane (PUR)
- ◆ Treated with PC to minimise the risk of infection and encrustation, therefore extended indwelling time
- ◆ Patented locking system ensures safe closure of the pigtail
- ◆ Drainage openings in pigtail
- ◆ Luer Lock Connector



Puncture Needle

- ◆ 2-part needle
- ◆ Medical stainless steel
- ◆ 18 G, length: 20 cm
- ◆ Ultrasonic visible

Guide Wire (Lunderquist)

- ◆ PTFE-coated

Universal Adapter

- ◆ Male Adapter with Luer Lock Connector
- ◆ 10 cm Silicone tube

MAGNUSSON LOCKING SYSTEM Nephrostomy Puncture-/Exchange Set

Seldinger technique, Treated with PC, with pigtail, with locking system

Single Catheter		
Size (FR/CH)	Length (cm)	Order Code Pigtail Catheter
08	24	RP-410840-FI
08	34	RP-410850-FI
09	24	RP-410940-FI
09	34	RP-410950-FI
10.5	30	RP-411050-FI

Puncture Set							
Size (FR/CH)	Length (cm)	Order Code Puncture Set	Dilators (FR/CH)	Guide Wire Length (cm)	Guide Wire Diameter	Guide Wire Tip (r=1.5 mm)	Guide Wire Stiffness
08	24	RP-400840-FI	07/09	80	0.035"	J-Tip	stiff
08	34	RP-400850-FI	07/09	80	0.035"	J-Tip	stiff
09	34	RP-400950-FI	08/10	80	0.035"	J-Tip	stiff
10.5	30	RP-401050-FI	08/12	80	0.035"	J-Tip	stiff

Exchange Set							
Size (FR/CH)	Length (cm)	Order Code Exchange Set	Dilators (FR/CH)	Guide Wire Length (cm)	Guide Wire Diameter	Guide Wire Tip	Guide Wire Stiffness
08	24	RP-400842-FI	08/09	80	0.035"	straight	stiff
08	34	RP-400852-FI	08/09	80	0.035"	straight	stiff
10.5	30	RP-401052-FI	10/12	80	0.035"	straight	stiff

MAGNUSSON LOCKING SYSTEM Nephrostomy Puncture Set

Two-step technique, with pigtail, with locking system

SET COMPONENTS

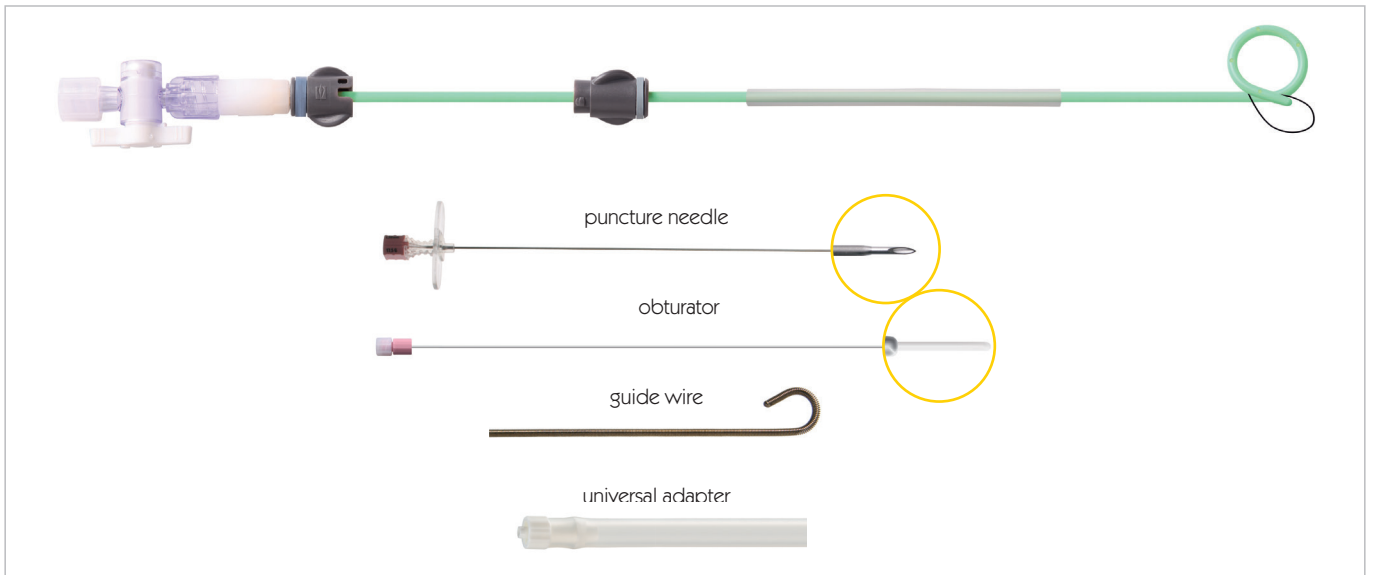

Nephrostomy Catheter

- ◆ Polyurethane (PUR)
- ◆ Patented locking system ensures safe closure of the pigtail
- ◆ Drainage openings in pigtail
- ◆ Luer Lock Connector

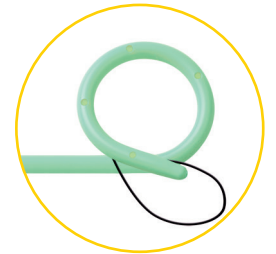

Puncture Needle

- ◆ 2-part needle
- ◆ Medical stainless steel
- ◆ 18 G, length: 20 cm
- ◆ Ultrasonic visible

Obturator

- ◆ Rounded tip for secure straightening of catheter

Schüller Guide Wire

- ◆ Uncoated stainless steel

Universal Adapter

- ◆ Male Adapter with Luer Lock Connector
- ◆ 10 cm Silicone tube

MAGNUSSON LOCKING SYSTEM Nephrostomy Puncture Set

Two-step technique, with pigtail, with locking system

Puncture Set						
Size (FR/CH)	Length (cm)	Order Code	Guide Wire Length (cm)	Guide Wire Diameter	Guide Wire Tip (r=3.0 mm)	Guide Wire Stiffness
08	22	RE-400892-FI	100	0.035"	J-Tip	stiff
09	22	RE-400992-FI	100	0.035"	J-Tip	stiff

RENODRAIN-DIRECT NEPHROSTOMY

One-step or two-step technique

SET COMPONENTS

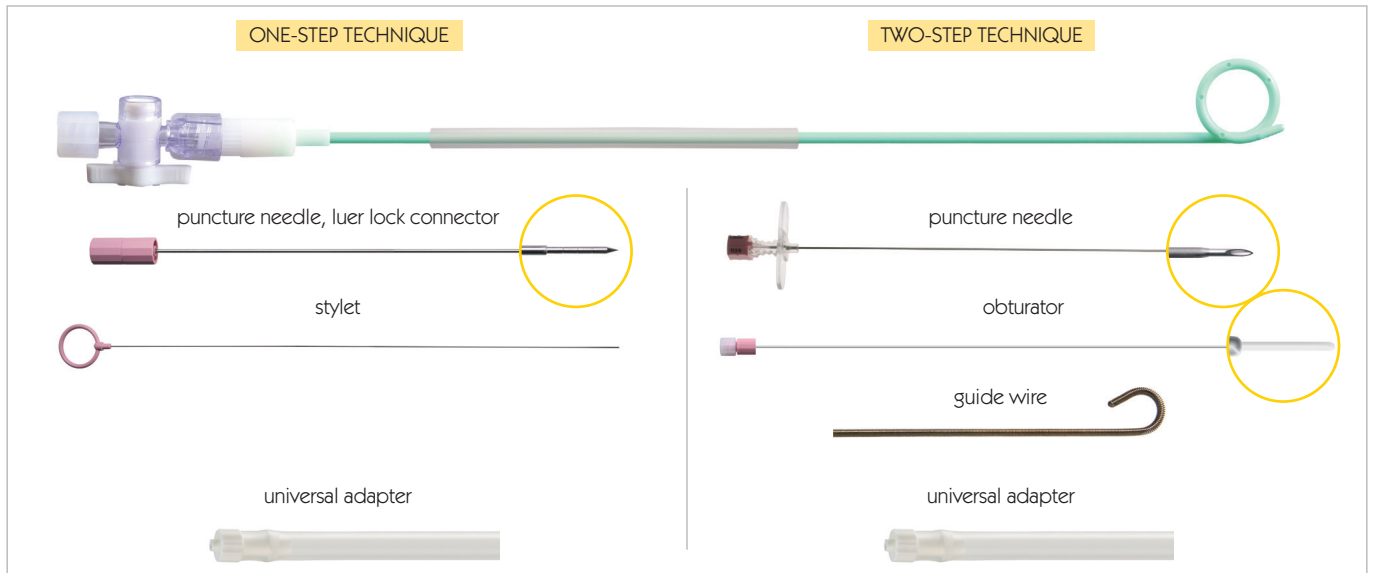

Nephrostomy Catheter

- ◆ Polyurethane (PUR)
- ◆ Tube to support insertion of stylet / obturator and puncture needle
- ◆ Luer Lock Connector

Puncture Needle

- ◆ 2-part needle
- ◆ 18 G, length: 20 cm
- ◆ Ultrasonic visible

Obturator/Stylet

- ◆ Rounded tip for secure straightening of catheter

Schüller Guide Wire

- ◆ Uncoated stainless steel

Universal Adapter

- ◆ Luer Lock Connector and funnel for attachment of the urinary drainage bag
- ◆ Length: 10 cm

RENODRAIN-DIRECT NEPHROSTOMY

One-step or two-step technique

One-Step Technique		
Size (FR/CH)	Length (cm)	Order Code
08	22	RE-400891

Two-Step Technique						
Size (FR/CH)	Length (cm)	Order Code	Guide Wire Length (cm)	Guide Wire Diameter	Guide Wire Tip (r=3.0 mm)	Guide Wire Stiffness
08	22	RE-400892	100	0.035"	J-Tip	stiff

RENODRAIN-YELLOW Nephrostomy Puncture- and Exchange Set

Seldinger technique, Treated with PC, with pigtail, with funnel

SET COMPONENTS

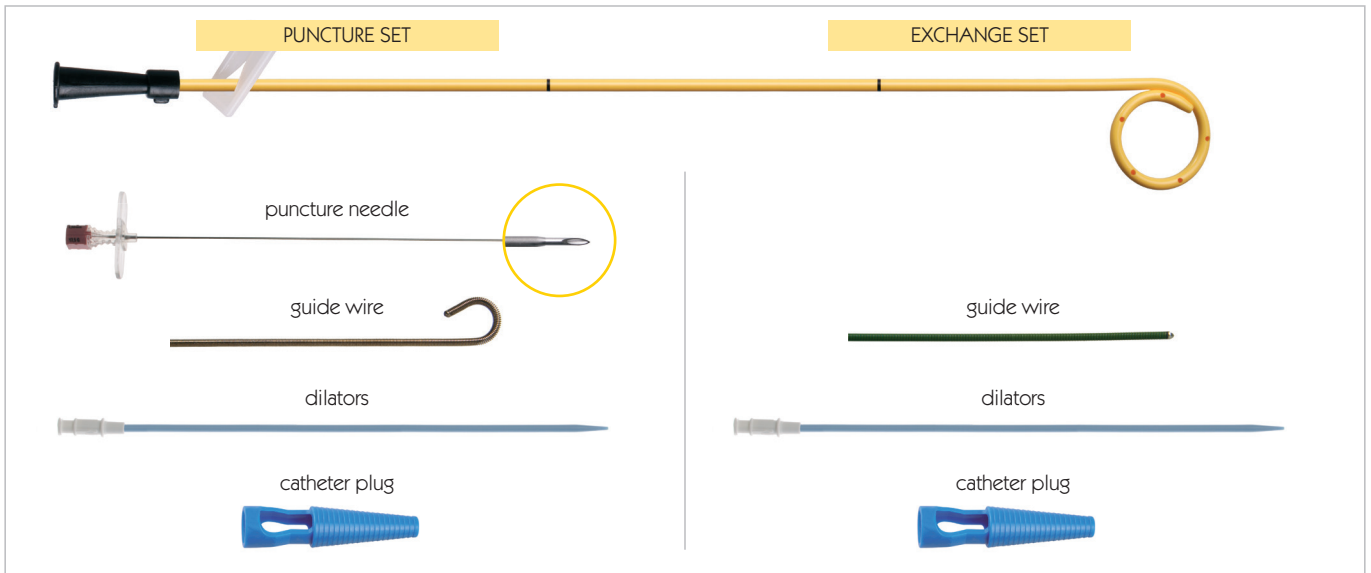

Nephrostomy Catheter

- ◆ Polyurethane (PUR)
- ◆ Treated with PC to minimise the risk of infection and encrustation, therefore extended indwelling time
- ◆ Drainage openings in pigtail
- ◆ Funnel for attachment of the urinary drainage bag

Puncture Needle

- ◆ 2-part needle
- ◆ Medical stainless steel
- ◆ 18 G, length: 20 cm
- ◆ Ultrasonic visible

Guide Wire (Lunderquist)

- ◆ PTFE-coated

RENODRAIN-YELLOW Nephrostomy Puncture- and Exchange Set

Seldinger technique, Treated with PC, with pigtail, with funnel

Single Catheter		
Size (FR/CH)	Length (cm)	Order Code Pigtail Catheter
10.5	28	RP-411140
14	28	RP-411440

Puncture Set							
Size (FR/CH)	Length (cm)	Order Code Puncture Set	Dilators (FR/CH) *with split sheath	Guide Wire Length (cm)	Guide Wire Diameter	Guide Wire Tip (r=1.5 mm)	Guide Wire Stiffness
11	28	RP-401140	08/12*	80	0.035"	J-Tip	stiff
14	28	RP-401440	10/14/16*	80	0.035"	J-Tip	stiff

Exchange Set							
Size (FR/CH)	Length (cm)	Order Code Exchange Set	Dilators (FR/CH) *with split sheath	Guide Wire Length (cm)	Guide Wire Diameter	Guide Wire Tip	Guide Wire Stiffness
11	28	RP-401142	10/12*	80	0.035"	straight	stiff
14	28	RP-401442	12/14/16*	80	0.035"	straight	stiff

RENODRAIN Nephrostomy Puncture- and Exchange Set

Seldinger technique, with pigtail, with funnel

SET COMPONENTS

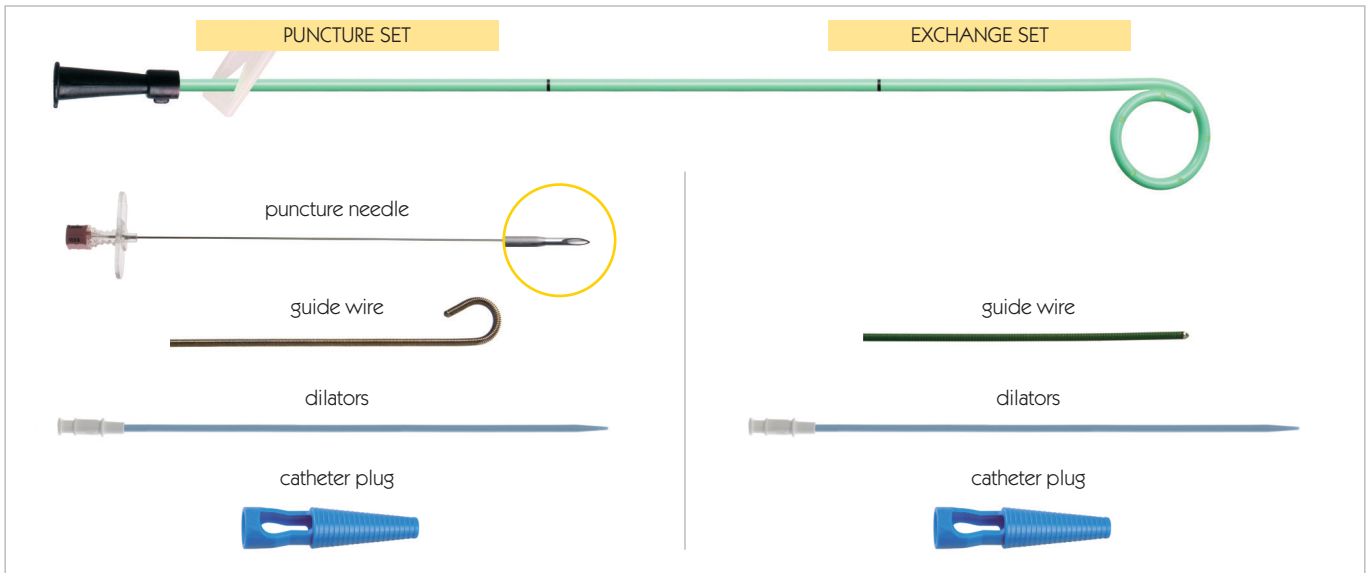

Nephrostomy Catheter

- ◆ Polyurethane (PUR)
- ◆ Drainage openings in pigtail
- ◆ Funnel for attachment of the urinary drainage bag

Puncture Needle

- ◆ 2-part needle
- ◆ Medical stainless steel
- ◆ 18 G, length: 20 cm
- ◆ Ultrasonic visible

Guide Wire (Lunderquist)

- ◆ PTFE-coated

RENODRAIN Nephrostomy Puncture- and Exchange Set

Seldinger technique, with pigtail, with funnel

Single Catheter		
Size (FR/CH)	Length (cm)	Order Code Pigtail Catheter
10.5	28	RE-411140
14	28	RE-411440

Puncture Set							
Size (FR/CH)	Length (cm)	Order Code Puncture Set	Dilators (FR/CH) *with split sheath	Guide Wire Length (cm)	Guide Wire Diameter	Guide Wire Tip (r=1.5 mm)	Guide Wire Stiffness
10.5	28	RC-401140	08/12*	80	0.035"	J-Tip	stiff
14	28	RC-401440	10/16*	80	0.035"	J-Tip	stiff

Exchange Set							
Size (FR/CH)	Length (cm)	Order Code Exchange Set	Dilators (FR/CH) *with split sheath	Guide Wire Length (cm)	Guide Wire Diameter	Guide Wire Tip	Guide Wire Stiffness
10.5	28	RC-401142	10/12*	80	0.035"	straight	stiff
14	28	RC-401442	14/16*	80	0.035"	straight	stiff

RENODRAIN-INTEGRALE Nephrostomy Puncture- and Exchange Set

Seldinger technique, 100% silicone, integrated balloon

SET COMPONENTS

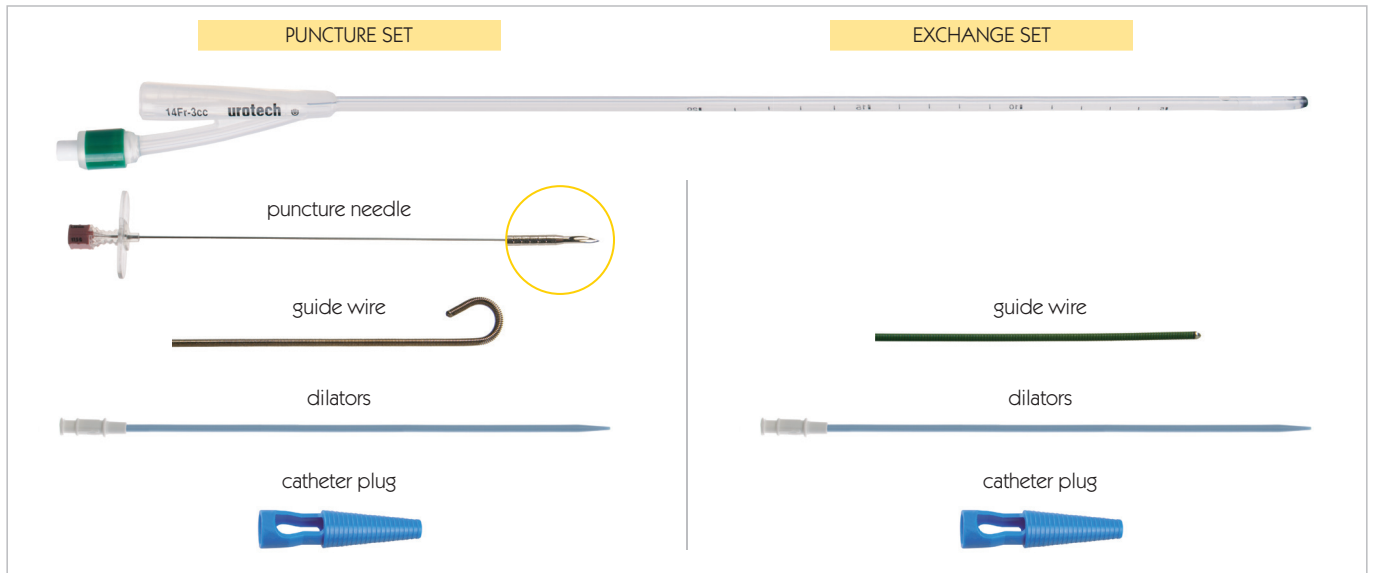

Balloon Catheter

- ◆ Silicone for optimal tissue compatibility
- ◆ Opening behind balloon to provide calyce drainage
- ◆ Integrated balloon
- ◆ Radiopaque contrast stripes
- ◆ Ultrasonic visible reinforced tip
- ◆ Markings for exact positioning



Puncture Needle

- ◆ 2-part needle
- ◆ Medical stainless steel
- ◆ 18 G, length: 20 cm
- ◆ Ultrasonic visible

Guide Wire (Lunderquist)

- ◆ PTFE-coated

RENODRAIN-INTEGRALE Nephrostomy Puncture- and Exchange Set

Seldinger technique, 100% silicone, integrated balloon

Single Catheter			
Size (FR/CH)	Length (cm)	Balloon (ml)	Order Code Single Catheter
10	40	1.5	NE-261005
12	30	2.0	NE-261225
12	40	2.0	NE-261205
14	30	3.0	NE-261425
14	40	3.0	NE-261405
16	30	5.0	NE-261625
16	40	5.0	NE-261605
18	30	5.0	NE-261825
18	40	5.0	NE-261805
20	40	5.0	NE-262005
22	40	5.0	NE-262205

Puncture Set								
Size (FR/CH)	Length (cm)	Balloon (ml)	Order Code Puncture Set	Dilators (FR/CH) *with split sheath	Guide Wire Length (cm)	Guide Wire Diameter	Guide Wire Tip (r=1.5 mm)	Guide Wire Stiffness
10	40	1.5	RE-401033	FR/CH 10/12*	70	0.025"	J-Tip	stiff
12	40	2.0	RE-401233	FR/CH 10/14*	70	0.025"	J-Tip	stiff
14	40	3.0	RE-401433	FR/CH 10/14/16*	80	0.035"	J-Tip	stiff
16	40	5.0	RE-401633	FR/CH 12/14/16*	80	0.035"	J-Tip	stiff

Exchange Set								
Size (FR/CH)	Length (cm)	Balloon (ml)	Order Code Exchange Set	Dilators (FR/CH) *with split sheath	Guide Wire Length (cm)	Guide Wire Diameter	Guide Wire Tip	Guide Wire Stiffness
10	40	1.5	RE-401032	FR/CH 10/12*	80	0.035"	straight	stiff
12	40	2.0	RE-401232	FR/CH 12/14*	80	0.035"	straight	stiff
14	40	3.0	RE-401432	FR/CH 14/16*	80	0.035"	straight	stiff
16	40	5.0	RE-401632	FR/CH 16/18*	80	0.035"	straight	stiff

RENODRAIN-BALLOON CATHETER

100% silicone, with hollow stylet

SET COMPONENTS

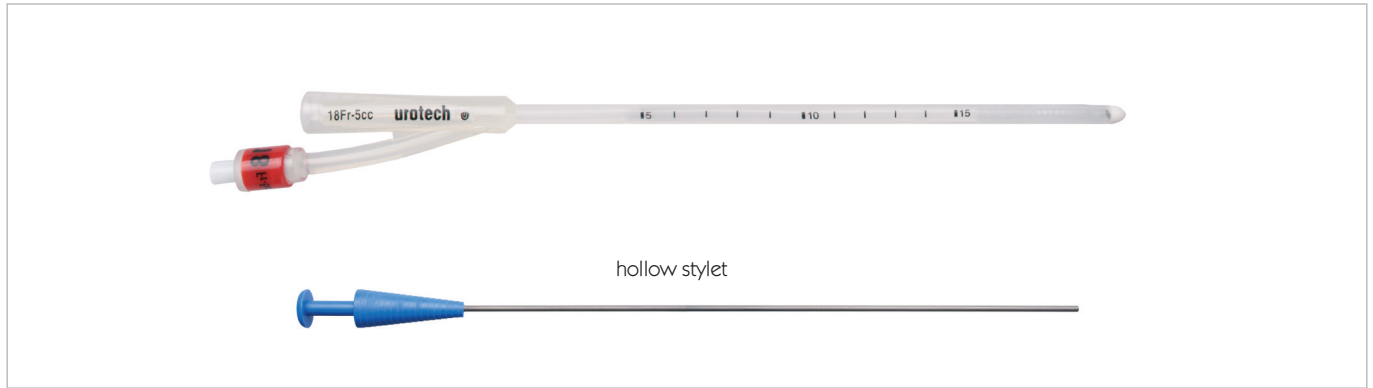

Balloon Catheter

- ◆ Silicone for optimal tissue compatibility
- ◆ Opening behind balloon to provide calyce drainage
- ◆ Integrated balloon
- ◆ Open reinforced tip
- ◆ Markings for exact positioning



Hollow Stylet

- ◆ To stabilise the balloon catheter

Size (FR/CH)	Length (cm)	Balloon (ml)	Order Code	Hollow Stylet Max. Guide Wire Diameter
12	40	2	NE-291205	0.035"
12	25	2	NE-291225	0.035"
14	40	3	NE-291405	0.035"
14	25	3	NE-291425	0.035"
16	40	5	NE-291605	0.035"
16	25	5	NE-291625	0.035"
18	40	5	NE-291805	0.035"
18	25	5	NE-291825	0.035"
20	40	5	NE-292005	0.035"
20	25	5	NE-292025	0.035"

RENODRAIN-INTEGRALE with detachable cone

100% silicone, with integrated balloon

SET COMPONENTS

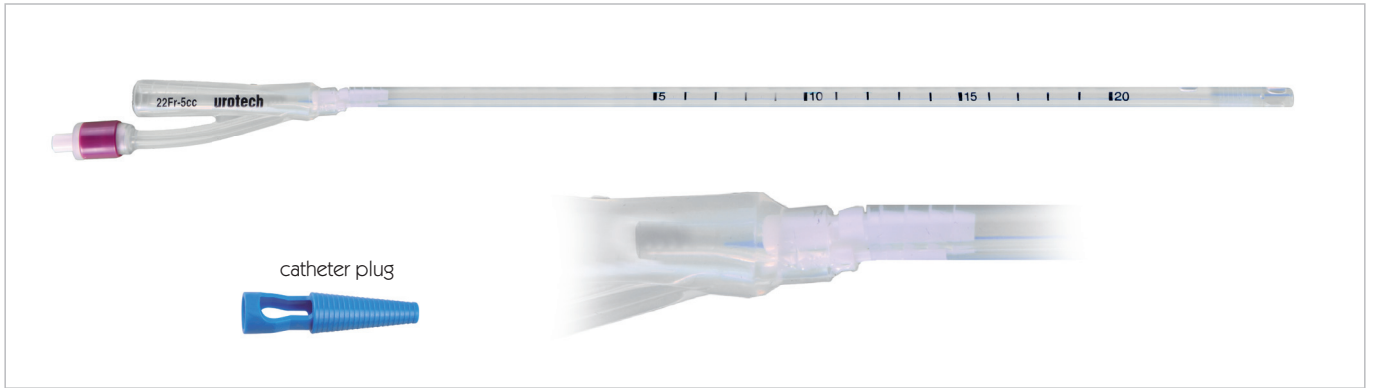

Balloon Catheter

- ◆ Silicone for optimal tissue compatibility
- ◆ Opening behind balloon to provide calyce drainage
- ◆ Integrated balloon
- ◆ Open reinforced tip
- ◆ Markings for exact positioning
- ◆ Detachable cone for telescope dilator

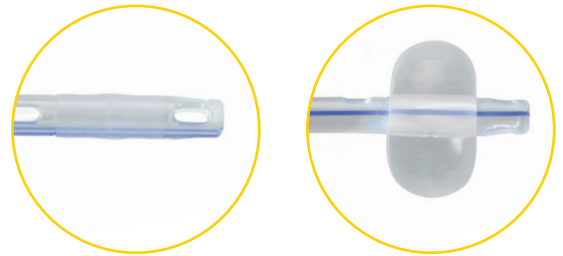

Size (FR/CH)	Length (cm)	Balloon (ml)	Order Code
22	40	5	NE-302205
24	40	5	NE-302405
26	40	5	NE-302605

REPOSITION CATHETER

For probing the nephrostomy channel after dislocation of a percutaneous or operative nephrostomy

SET COMPONENTS

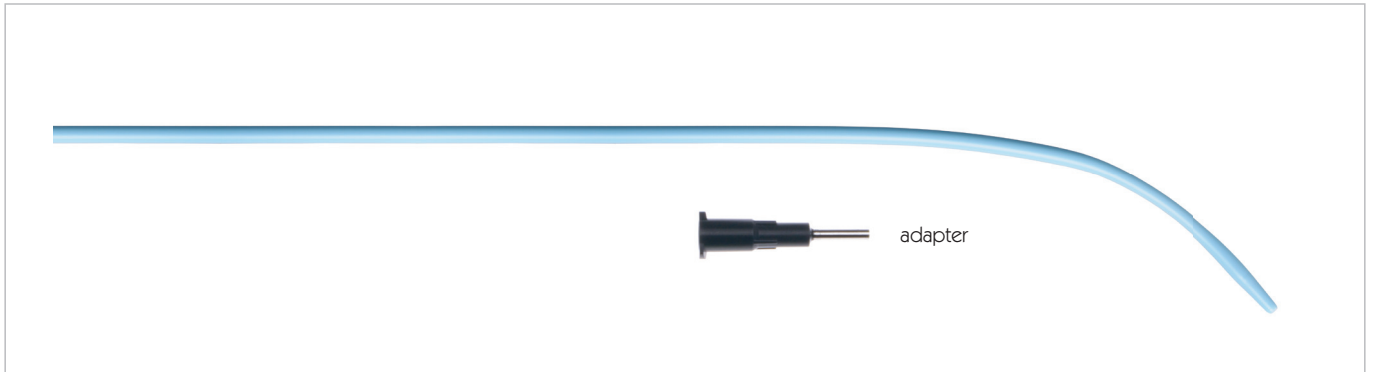

Catheter

- ◆ Polyurethane (PUR)
- ◆ Bent tip (45° bend)
- ◆ Open tip
- ◆ Radiopaque

Size (FR/CH)	Length (cm)	Order Code	Max. Guide Wire Diameter
06	50	RE-650	0.035"

SUPRAPUBIC
BLADDER DRAINAGE



Suprapubic Bladder
Drainage

Accessories

Ureteral Catheters

Foley Catheters

Stone Baskets

Urodynamic

Special Products

Care Products

Pediatric Urology



UROTECH

SUPRA-FIX Puncture- and Exchange Set

With pigtail, with funnel

SET COMPONENTS

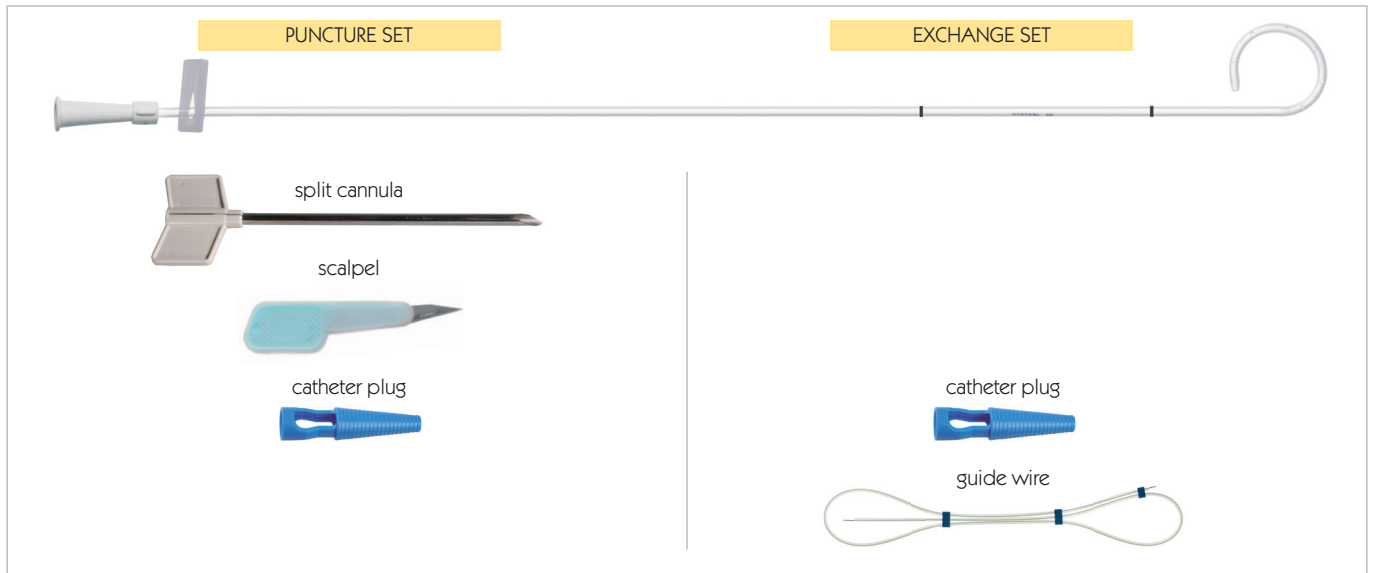

Pigtail Catheter

- ◆ Polyurethane (PUR)
- ◆ Flexible pigtail to avoid irritation
- ◆ Funnel for attachment of the urinary drainage bag
- ◆ Markings for exact positioning



Split Cannula

- ◆ Medical stainless steel
- ◆ Easy and safe splitting

Guide Wire (only in Exchange Set)

- ◆ PTFE-coated

SUPRA-FIX Puncture- and Exchange Set

With pigtail, with funnel

Puncture Set / Catheter					
Size (FR/CH)	Length (cm)	Order Code only Pigtail Catheter	Order Code Puncture Set	Split Cannula Size Ø (mm)	Split Cannula Length (cm)
8.0	65	SU-130865	SU-101040	3.6	12
10	65	SU-131065	SU-101046	4.6	12
12	65	SU-131265	SU-101240	5.6	12

Exchange Set						
Size (FR/CH)	Length (cm)	Order Code Exchange Set	Guide Wire Length (cm)	Guide Wire Diameter	Guide Wire Tip	Guide Wire Stiffness
8.0	65	SU-131040	100	0.038"	straight	standard
10	65	SU-131046	100	0.038"	straight	standard
12	65	SU-131240	100	0.038"	straight	standard

SUPRA-FIX TUR TUR-Puncture Set

With pigtail, with funnel

SET COMPONENTS

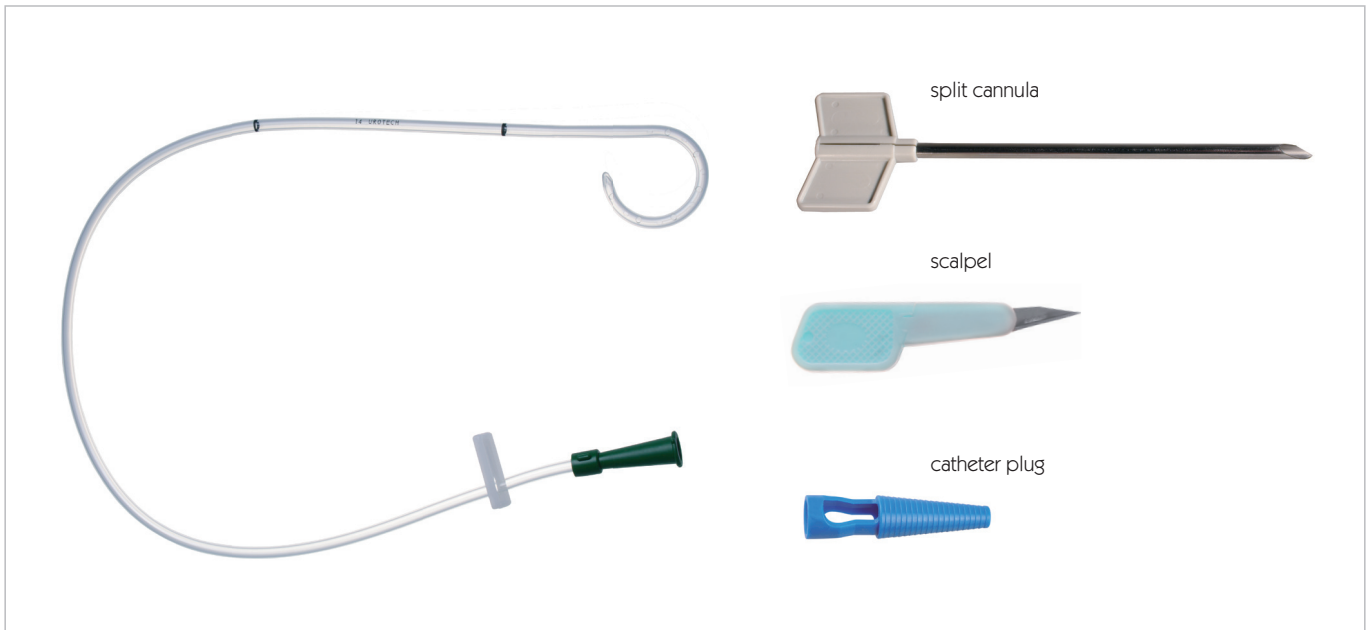

Pigtail Catheter

- ◆ Polyurethane (PUR)
- ◆ Open or closed tip
- ◆ Very suitable for drainage and irrigation during TUR procedure
- ◆ Flexible pigtail to avoid irritation
- ◆ Optimal urine drainage due to drainage holes in pigtail
- ◆ Funnel for attachment of the urinary drainage bag
- ◆ Markings for exact positioning



Split Cannula

- ◆ Medical stainless steel
- ◆ Easy and safe splitting

SUPRA-FIX TUR TUR-Puncture Set

With pigtail, with funnel

Open tip				
Size (FR/CH)	Length (cm)	Order Code	Split Cannula Size Ø (mm)	Split Cannula Length (cm)
14	65	SU-121640	5.6	12

Closed tip				
Size (FR/CH)	Length (cm)	Order Code	Split Cannula Size Ø (mm)	Split Cannula Length (cm)
14	65	SU-121540	5.6	12

SUPRA-FIX BK Puncture-, Exchange- and Dilation Exchange Set

100% silicone, with pigtail, with integrated balloon

SET COMPONENTS

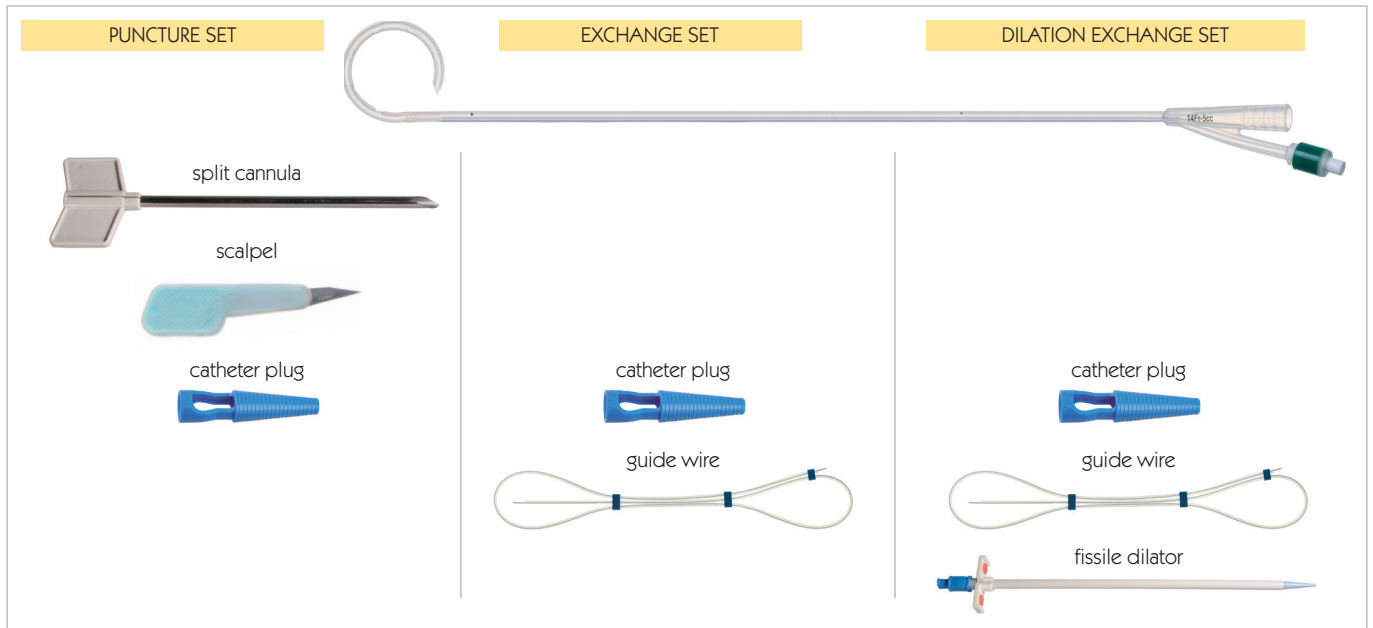

Balloon Catheter

- ◆ Silicone for optimal tissue compatibility
- ◆ Flexible pigtail to avoid irritation
- ◆ Markings for exact positioning



Split Cannula

- ◆ Medical stainless steel
- ◆ Easy and safe splitting

Guide Wire (only in Exchange Set)

- ◆ PTFE-coated

SUPRA-FIX BK Puncture-, Exchange- and Dilation Exchange Set
 100% silicone, with pigtail, with integrated balloon

Puncture Set / Catheter						
Size (FR/CH)	Length (cm)	Balloon (ml)	Order Code only Balloon Catheter	Order Code Puncture Set	Split Cannula Size Ø (mm)	Split Cannula Length (cm)
12	40	05	SU-251205	SU-121240	5.6	12
14	40	05	SU-251405	SU-121440	5.6	12
16	40	10	SU-251605			
18	40	10	SU-251805			

Exchange Set							
Size (FR/CH)	Length (cm)	Balloon (ml)	Order Code Exchange Set	Guide Wire Length (cm)	Guide Wire Diameter	Guide Wire Tip	Guide Wire Stiffness
12	40	05	SU-124540	100	0.038"	straight	standard
14	40	05	SU-124640	100	0.038"	straight	standard
16	40	10	SU-124740	100	0.038"	straight	standard
18	40	10	SU-124840	100	0.038"	straight	standard

Dilation Exchange Set								
Size (FR/CH)	Length (cm)	Balloon (ml)	Order Code Dilation Exchange Set	Dilator (FR/CH)	Guide Wire Length (cm)	Guide Wire Diameter	Guide Wire Tip	Guide Wire Stiffness
12	40	05	SU-124541	14	100	0.038"	straight	standard
14	40	05	SU-124641	16	100	0.038"	straight	standard
16	40	10	SU-124741	18	100	0.038"	straight	standard

SUPRA-FIX-INTEGRALE Puncture-, Exchange- and Dilation Exchange Set

100% silicone, with integrated balloon

SET COMPONENTS

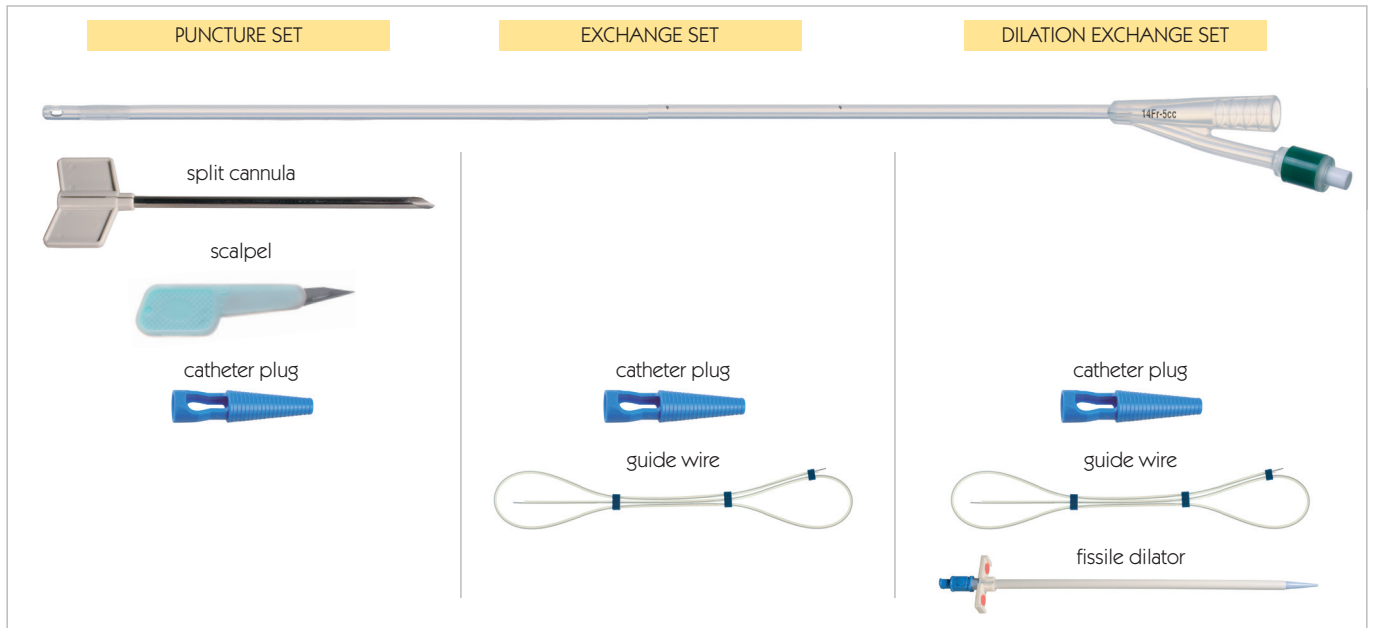

Balloon Catheter

- ◆ Silicone for optimal tissue compatibility
- ◆ Markings for exact positioning



Split Cannula

- ◆ Medical stainless steel
- ◆ Easy and safe splitting

Guide Wire (only in Exchange Set)

- ◆ PTFE-coated

SUPRA-FIX-INTEGRALE Puncture-, Exchange- and Dilation Exchange Set 100% silicone, with integrated balloon

Puncture Set / Catheter						
Size (FR/CH)	Length (cm)	Balloon (ml)	Order Code only Balloon Catheter	Order Code Puncture Set	Split Cannula Size Ø (mm)	Split Cannula Length (cm)
08	30	1.5	SU-270825	SU-110826	3.6	08
10	30	3.0	SU-271025	SU-111026	4.6	08
10	40	3.0	SU-271005	SU-111030	4.6	12
12	30	5.0	SU-271225	SU-111226	4.6	08
12	40	5.0	SU-271205	SU-111230	4.6	12
14	30	5.0	SU-271425			
14	40	5.0	SU-271405	SU-111430	5.6	12
16	30	5-10	SU-271625			
16	40	5-10	SU-271605			
18	30	5-10	SU-271825			
18	40	5-10	SU-271805			
20	30	5-10	SU-272025			
20	40	5-10	SU-272005			
22	30	5-10	SU-272225			
22	40	5-10	SU-272205			
24	40	5-10	SU-272405			

Exchange Set							
Size (FR/CH)	Length (cm)	Balloon (ml)	Order Code Exchange Set	Guide Wire Length (cm)	Guide Wire Diameter	Guide Wire Tip	Guide Wire Stiffness
08	30	1.5	SU-140826	100	0.025"	straight	standard
10	30	3.0	SU-141026	100	0.032"	straight	standard
10	40	3.0	SU-141030	100	0.032"	straight	standard
12	30	5.0	SU-141226	100	0.032"	straight	standard
12	40	5.0	SU-141230	100	0.032"	straight	standard
14	30	5.0	SU-141426	100	0.038"	straight	standard
14	40	5.0	SU-141430	100	0.038"	straight	standard
16	30	5-10	SU-141626	100	0.038"	straight	standard
16	40	5-10	SU-141630	100	0.038"	straight	standard
18	30	5-10	SU-141826	100	0.038"	straight	standard
18	40	5-10	SU-141830	100	0.038"	straight	standard
20	40	5-10	SU-142030	100	0.038"	straight	standard

Dilation Exchange Set								
Size (FR/CH)	Length (cm)	Balloon (ml)	Order Code Dilation Exchange Set	Dilator (FR/CH)	Guide Wire Length (cm)	Guide Wire Diameter	Guide Wire Tip	Guide Wire Stiffness
10	40	3.0	SU-141031	12	100	0.032"	straight	standard
12	40	5.0	SU-141231	14	100	0.032"	straight	standard
14	40	5.0	SU-141431	16	100	0.038"	straight	standard
16	40	5-10	SU-141631	18	100	0.038"	straight	standard

SUPRA-FIX SOFT Exchange Set

Latex, with silicone elastomeric coating

SET COMPONENTS

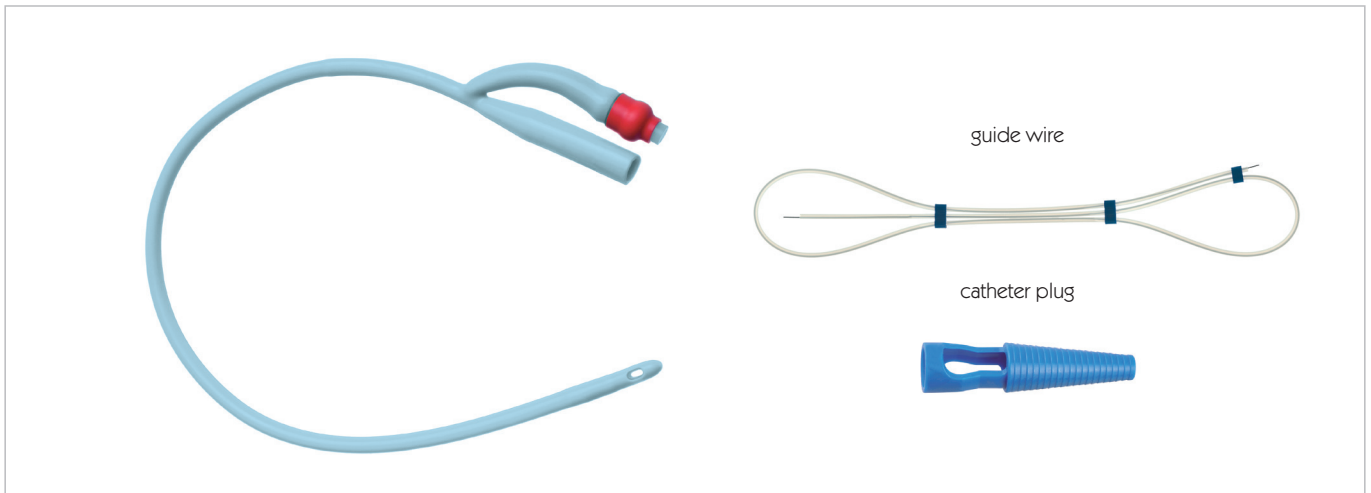

Balloon Catheter

- ◆ Silicone for optimal tissue compatibility
- ◆ High elasticity of balloon
- ◆ No loss of balloon blockage, no refilling of balloon during indwelling time necessary



Guide Wire (only in Exchange Set)

- ◆ PTFE-coated

Exchange Set / Catheter								
Size (FR/CH)	Length (cm)	Balloon (ml)	Order Code Balloon Catheter	Order Code Exchange Set	Guide Wire Length (cm)	Guide Wire Diameter	Guide Wire Tip	Guide Wire Stiffness
14	41	10	SU-291405	SU-161440	100	0.038"	straight	standard
16	41	10	SU-291605	SU-161640	100	0.038"	straight	standard
18	41	10	SU-291805	SU-161840	100	0.038"	straight	standard
20	41	10	SU-292005					
22	41	10	SU-292205					

SUPRA-FIX Suprapubic Balloon Catheter

100% silicone, with hollow stylet, with integrated balloon

SET COMPONENTS

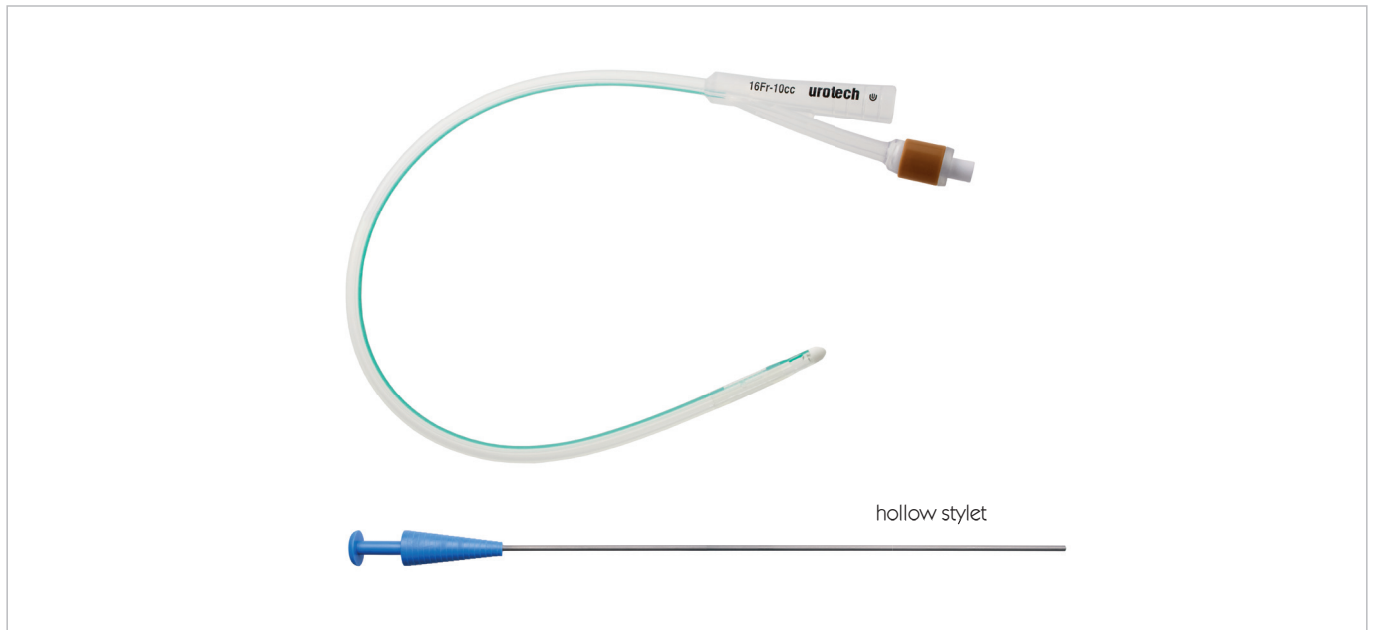

Balloon Catheter

- ◆ Silicone for optimal tissue compatibility
- ◆ Reinforced tip
- ◆ Markings for exact positioning



Hollow Stylet

- ◆ To stabilise the balloon catheter

Size (FR/CH)	Length (cm)	Balloon (ml)	Order Code	Hollow Stylet Max. Guide Wire Diameter
12	40	5	SU-241205	0.035"
14	40	5	SU-241405	0.035"
16	40	10	SU-241605	0.035"
18	40	10	SU-241805	0.035"
20	40	10	SU-242005	0.035"

ACCESSORIES



GUIDE WIRES

STANDARD GUIDE WIRE



Standard – PTFE-coated stainless steel					
Order Codes	Diameter (inch)	Length (cm)	Tip	Tip Stiffness	Shaft Stiffness
EN-340028	0.028"	100	straight	standard	standard
EN-340032	0.032"	100	straight	standard	standard
EN-340035	0.035"	100	straight	standard	standard
EN-340038	0.038"	100	straight	standard	standard
SU-120101	0.045"	100	straight	standard	standard
EN-340125	0.025"	125	straight	standard	standard
EN-340128	0.028"	125	straight	standard	standard
EN-340135	0.035"	125	straight	standard	standard
EN-340135-S	0.035"	125	straight	standard	stiff
EN-340228	0.028"	145	straight	standard	standard
EN-340150	0.035"	150	straight	standard	standard
EN-340035-J3	0.035"	100	J-tip (3.0 mm)	standard	standard

Lunderquist – PTFE-coated stainless steel					
Order Codes	Diameter (inch)	Length (cm)	Tip	Tip Stiffness	Shaft Stiffness
RE-420170	0.025"	70	straight	standard	stiff
RE-420780	0.035"	80	J-tip (1.5 mm)	standard	stiff
RE-420380	0.035"	80	J-tip (3.0 mm)	standard	stiff
RE-420180	0.035"	80	straight	standard	stiff

With movable core – PTFE-coated stainless steel					
Order Codes	Diameter (inch)	Length (cm)	Tip	Tip Stiffness	Shaft Stiffness
RE-420210	0.035"	125	straight	standard	standard
RE-420211	0.035"	150	straight	standard	standard

Schüller Guide Wire – uncoated stainless steel					
Order Codes	Diameter (inch)	Length (cm)	Tip 9 cm	Tip Stiffness	Shaft Stiffness
RE-430300	0.035"	100	J-tip (3.0 mm)	standard	stiff

TIGER GUIDE WIRE



- Black-yellow swivelled, better control of wire movement
- Nitinol-core prevents kinking
- PTFE-coating supports easy and fast placement and ensures optimal gliding property for instruments

Order Codes	Diameter (inch)	Length (cm)	Tip	Tip Stiffness	Shaft Stiffness
UTD-35150	0.035"	150	straight	standard	standard
UTD-35150-A	0.035"	150	bent	standard	standard

SEMISLIP



- Suitable for all urological procedures
- 5 cm, very flexible and hydrophilic tip provides non-traumatic insertion and safe bypass of obstructions
- PTFE-coated shaft supports easy and fast placement and reduces the risk of dislocation during urological procedures

Order Codes	Diameter (inch)	Length (cm)	Tip	Tip Stiffness	Shaft Stiffness
UAS-35150-S	0.035"	150	straight	standard	standard

ACCESSORIES

UROLIX – HYDROPHILIC-COATED

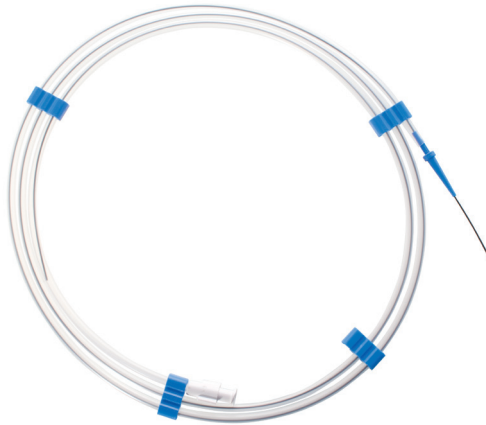

Attention: To receive optimal results of the hydrophilic effect, please moisturise the guide wire prior to use!

- 🔹 High flexibility and kink-resistance
- 🔹 Nitinol-core

Urolix					
Order Codes	Diameter (inch)	Length (cm)	Tip	Tip Stiffness	Shaft Stiffness
UXN-SS-2515	0,025"	150 cm	straight	standard	standard
UXN-SS-3215	0,032"	150 cm	straight	standard	standard
UXN-SS-3515	0,035"	150 cm	straight	standard	standard
UXN-SS-3815	0,038"	150 cm	straight	standard	standard
UXN-SF-2515	0,025"	150 cm	straight	floppy / 70 mm	standard
UXN-SF-3215	0,032"	150 cm	straight	floppy / 70 mm	standard
UXN-SF-3515	0,035"	150 cm	straight	floppy / 70 mm	standard
UXN-SF-3815	0,038"	150 cm	straight	floppy / 70 mm	standard
UXS-SS-2515	0,025"	150 cm	straight	standard	stiff
UXS-SS-3215	0,032"	150 cm	straight	standard	stiff
UXS-SS-3515	0,035"	150 cm	straight	standard	stiff
UXS-SS-3815	0,038"	150 cm	straight	standard	stiff
UXN-CS-2515	0,025"	150 cm	angled	standard	standard
UXN-CS-3215	0,032"	150 cm	angled	standard	standard
UXN-CS-3515	0,035"	150 cm	angled	standard	standard
UXN-CS-3815	0,038"	150 cm	angled	standard	standard
UXS-CS-2515	0,025"	150 cm	angled	standard	stiff
UXS-CS-3215	0,032"	150 cm	angled	standard	stiff
UXS-CS-3515	0,035"	150 cm	angled	standard	stiff

PLATINPUSHER Pusher with radiopaque marker

DESCRIPTION



Pusher

- ◆ Marker indicates precise location of the pusher
- ◆ Supports correct stent positioning
- ◆ Special length for endoscopic working channel

Size (FR/CH)	Length (cm)	Order Code	Max. Guide Wire Diameter
05	45	PU-0545-RM	0.028"
05	70	PU-0570-RM	0.028"
06	45	PU-0645-RM	0.035"
06	70	PU-0670-RM	0.035"
07	45	PU-0745-RM	0.035"
08	45	PU-0845-RM	0.038"

NEPHROSTOMY PUNCTURE NEEDLES

Ultrasonic visible due to sandblasted cannula tip or ring marking

1-part cannula

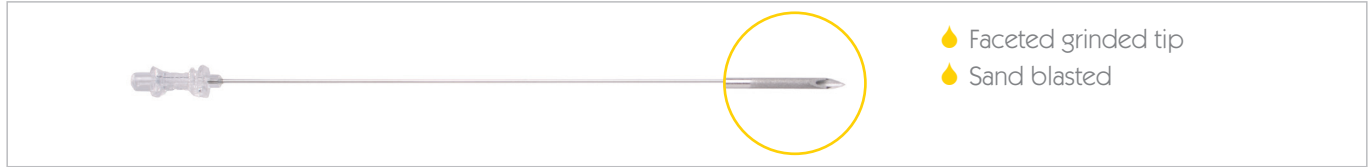

- ◆ Faceted grinded tip
- ◆ Sand blasted

Size (G)	Length (cm)	Order Code	Max. Guide Wire Diameter
19	20	RE-440620	0.035"

2-part cannula



- ◆ Faceted grinded tip
- ◆ Sand blasted

Size (G)	Length (cm)	Order Code	Max. Guide Wire Diameter
18	19.5	RE-440720	0.035"

3-part cannula

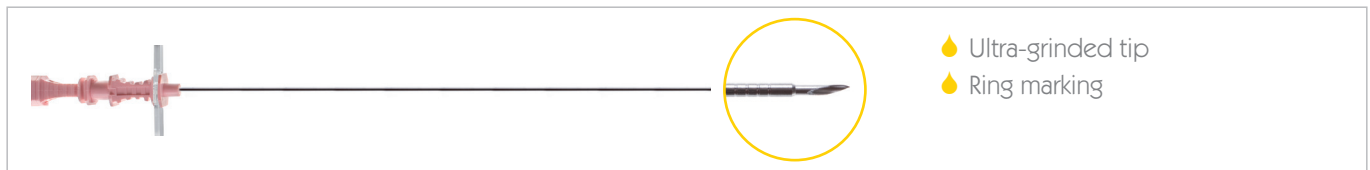

- ◆ Ultra-grinded tip
- ◆ Ring marking

Size (G)	Length (cm)	Order Code	Max. Guide Wire Diameter
18	20	RE-440320	0.035"

BIOPSY CANNULA

For automatic biopsy

- Optimized cut for histological findings
- Centimeter graduation for precise penetration depth
- Echogenic tip for clear ultrasound visibility
- Clear size recognition by color coating

DNG-1010 among others suitable for PRO-MAG™ 2.2



DNG-1020 among others suitable for PRO-MAG™ Ultra

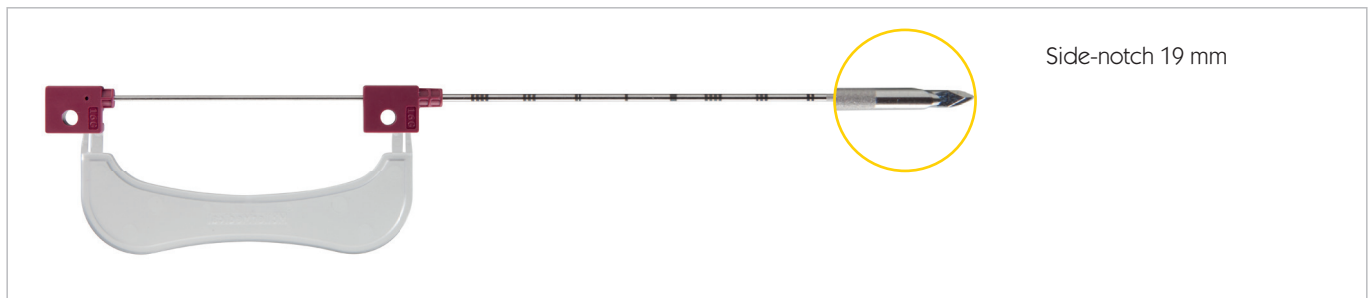

Size (G)	Length (cm)	Order Code	Matching Coaxial Needle
14	10	DNG-1010-14-0100	COX-1010-14-0046
14	12	DNG-1010-14-0120	
14	16	DNG-1010-14-0160	COX-1010-14-0106
14	20	DNG-1010-14-0200	
16	10	DNG-1010-16-0100	COX-1010-16-0046
16	16	DNG-1010-16-0160	COX-1010-16-0106
16	20	DNG-1010-16-0200	
16	25	DNG-1010-16-0250	
18	10	DNG-1010-18-0100	COX-1010-18-0049
18	16	DNG-1010-18-0160	COX-1010-18-0106
18	20	DNG-1010-18-0200	COX-1010-18-0146
18	25	DNG-1010-18-0250	
18	30	DNG-1010-18-0300	
20	10	DNG-1010-20-0100	COX-1010-20-0049
20	16	DNG-1010-20-0160	COX-1010-20-0109
20	20	DNG-1010-20-0200	

Size (G)	Length (cm)	Order Code	Matching Coaxial Needle
14	10	DNG-1020-14-0100	COX-1020-14-0046
14	12	DNG-1020-14-0120	
14	16	DNG-1020-14-0160	COX-1020-14-0106
14	20	DNG-1020-14-0200	
16	10	DNG-1020-16-0100	COX-1020-16-0046
16	16	DNG-1020-16-0160	COX-1020-16-0106
16	20	DNG-1020-16-0200	
16	25	DNG-1020-16-0250	
18	10	DNG-1020-18-0100	COX-1020-18-0046
18	16	DNG-1020-18-0160	COX-1020-18-0106
18	20	DNG-1020-18-0200	COX-1020-18-0146
18	25	DNG-1020-18-0250	
18	30	DNG-1020-18-0300	
20	10	DNG-1020-20-0100	COX-1020-20-0049
20	16	DNG-1020-20-0160	COX-1020-20-0109
20	20	DNG-1020-20-0200	

BIOPSY CANNULA

For automatic biopsy

- ◆ Optimized cut for histological findings
- ◆ Centimeter graduation for precise penetration depth
- ◆ Echogenic tip for clear ultrasound visibility
- ◆ Clear size recognition by color coating

DNG-1040 among others suitable for Bard® Magnum®



Size (G)	Length (cm)	Order Code	Matching Coaxial Needle
14	10	DNG-1040-14-0100	COX-1040-14-0043
14	13	DNG-1040-14-0130	
14	16	DNG-1040-14-0160	COX-1040-14-0103
14	20	DNG-1040-14-0200	
16	10	DNG-1040-16-0100	COX-1040-16-0043
16	13	DNG-1040-16-0130	
16	16	DNG-1040-16-0160	COX-1040-16-0103
16	20	DNG-1040-16-0200	
18	10	DNG-1040-18-0100	COX-1040-18-0043
18	13	DNG-1040-18-0130	
18	16	DNG-1040-18-0160	COX-1040-18-0103
18	20	DNG-1040-18-0200	COX-1040-18-0143
18	25	DNG-1040-18-0250	
18	30	DNG-1040-18-0300	
20	10	DNG-1040-20-0100	COX-1040-20-0046
20	13	DNG-1040-20-0130	
20	16	DNG-1040-20-0160	COX-1040-20-0106
20	20	DNG-1040-20-0200	

COAXIAL NEEDLE

- ◆ Allows multiple sampling through only one percutaneous puncture
- ◆ Centimeter graduation and infinitely variable spring clips for exact determination of penetration depth
- ◆ Echogenic tip for clear ultrasound visibility
- ◆ Luer Lock adapter for anesthetic application

COX

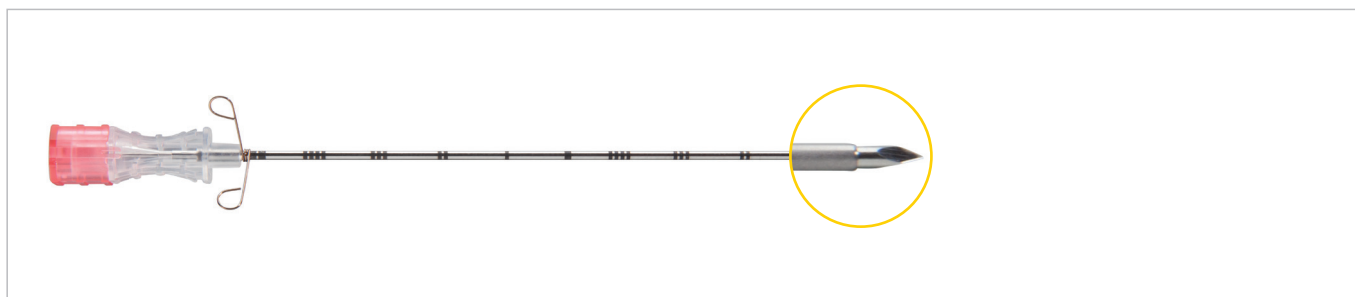

Size (G)	Length (cm)	Order Code
13	4,6	COX-1010-14-0046
13	10,6	COX-1010-14-0106
15	4,6	COX-1010-16-0046
15	10,6	COX-1010-16-0106
17	4,6	COX-1010-18-0049
17	10,6	COX-1010-18-0106
17	14,6	COX-1010-18-0146
19	4,9	COX-1010-20-0049
19	10,9	COX-1010-20-0109
13	4,6	COX-1020-14-0046
13	10,6	COX-1020-14-0106
15	4,6	COX-1020-16-0046
15	10,6	COX-1020-16-0106
17	4,6	COX-1020-18-0046
17	10,6	COX-1020-18-0106
17	14,6	COX-1020-18-0146
19	4,9	COX-1020-20-0049
19	10,9	COX-1020-20-0109
13	4,3	COX-1040-14-0043
13	10,3	COX-1040-14-0103
15	4,3	COX-1040-16-0043
15	10,3	COX-1040-16-0103
17	4,3	COX-1040-18-0043
17	10,3	COX-1040-18-0103
17	14,3	COX-1040-18-0143
19	4,6	COX-1040-20-0046
19	10,6	COX-1040-20-0106

Size (G)	Length (cm)	Order Code
13	5,1	COX-2000-14-0051
13	10,1	COX-2000-14-0101
13	15,1	COX-2000-14-0151
15	5,1	COX-2000-16-0051
15	10,1	COX-2000-16-0101
15	15,1	COX-2000-16-0151
17	5,1	COX-2000-18-0051
17	10,1	COX-2000-18-0101
17	15,1	COX-2000-18-0151
17	20,1	COX-2000-18-0201
19	5,1	COX-2000-20-0051
19	10,1	COX-2000-20-0101
19	15,1	COX-2000-20-0151

DISPOSABLE BIOPSY GUN

For automatic biopsy

- ◆ Optimized cut to obtain high quality histological samples
- ◆ Centimeter markings for exact positioning
- ◆ Echogenic tip for clear visibility using ultrasound
- ◆ One-hand-use with choice of driver either on side or back
- ◆ Can be used semi- or full automatic
- ◆ Side-notch 19 mm

ABG-2020

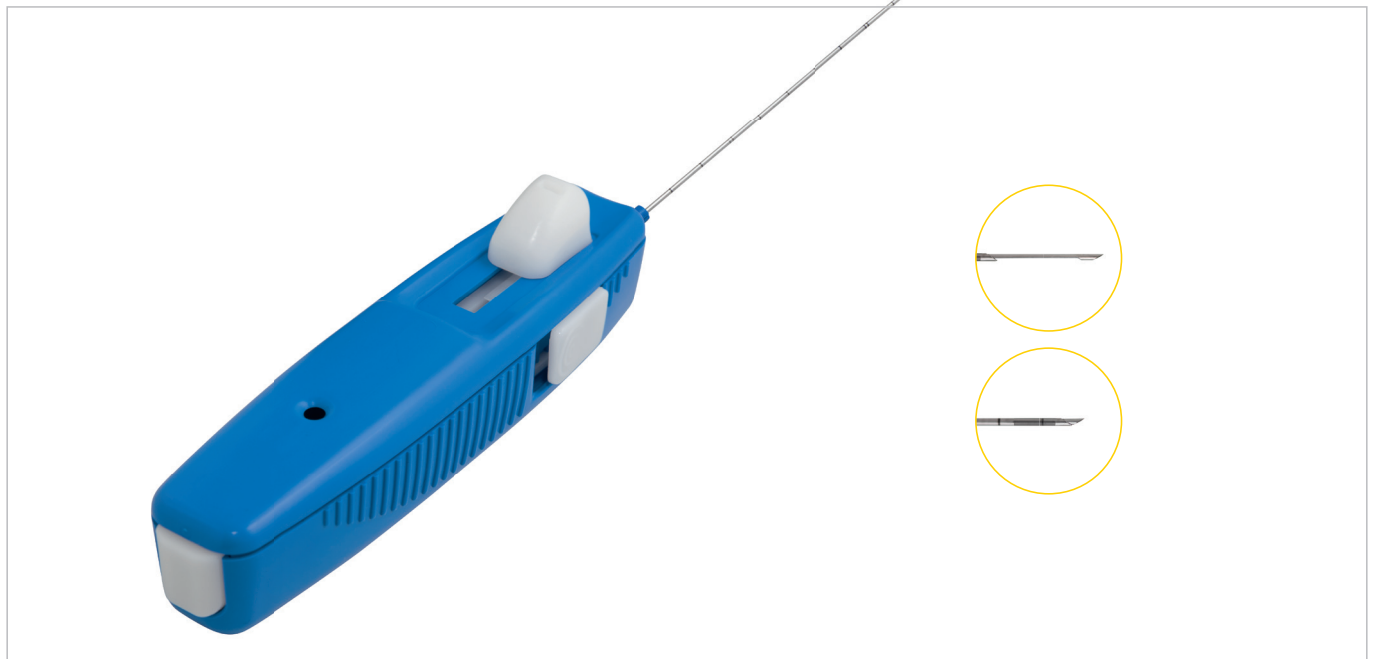

Size (G)	Length (cm)	Order Code	suitable for coaxial Needle
14	10	ABG-2020-14-0100	COX-2000-14-0051
14	15	ABG-2020-14-0150	COX-2000-14-0101
14	20	ABG-2020-14-0200	COX-2000-14-0151
16	10	ABG-2020-16-0100	COX-2000-16-0051
16	15	ABG-2020-16-0150	COX-2000-16-0101
16	20	ABG-2020-16-0200	COX-2000-16-0151
18	10	ABG-2020-18-0100	COX-2000-18-0051
18	15	ABG-2020-18-0150	COX-2000-18-0101
18	20	ABG-2020-18-0200	COX-2000-18-0151
18	25	ABG-2020-18-0250	COX-2000-18-0201
20	10	ABG-2020-20-0100	COX-2000-20-0051
20	15	ABG-2020-20-0150	COX-2000-20-0101
20	20	ABG-2020-20-0200	COX-2000-20-0151

DISPOSABLE BIOPSY GUN

For automatic biopsy

- ◆ Optimized cut to obtain high quality histological samples
- ◆ Centimeter markings for exact positioning
- ◆ Echogenic tip for clear visibility using ultrasound
- ◆ One-hand-use with choice of driver either on side or back
- ◆ full automatic
- ◆ Side-notch 20 mm
- ◆ Strong spring tension

ABG-2040

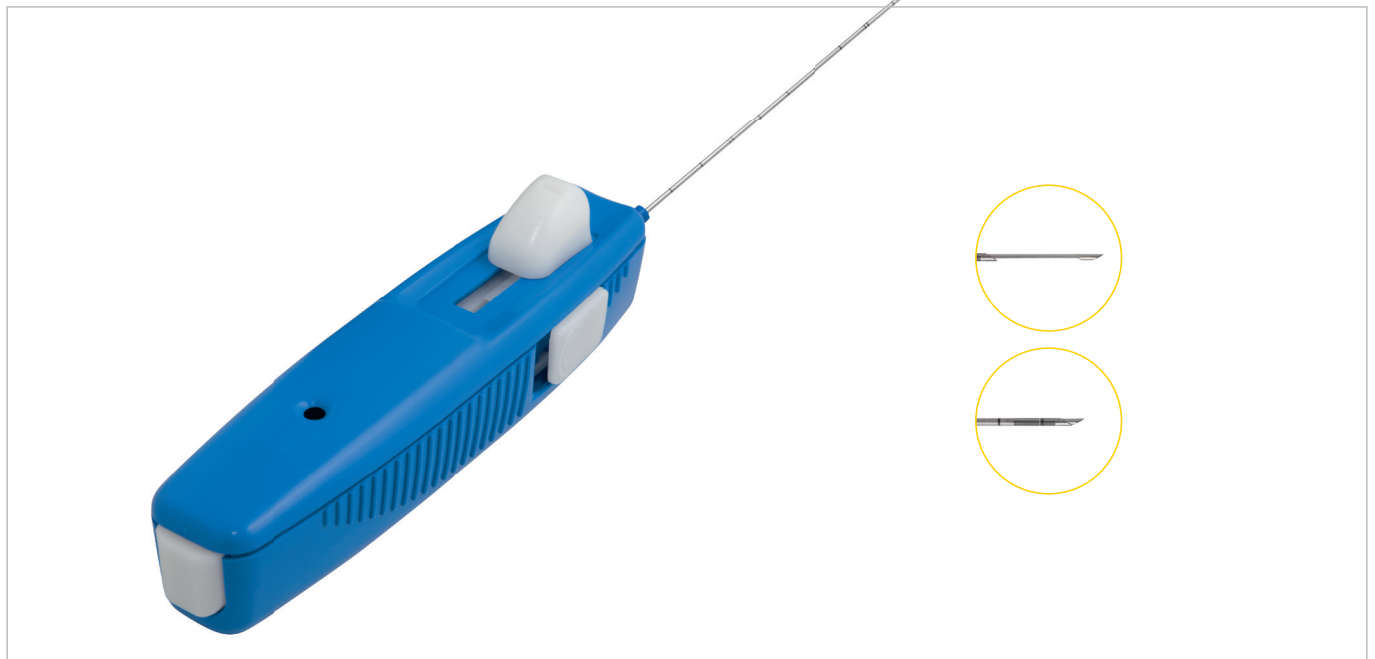

Size (G)	Length (cm)	Order Code	suitable for coaxial Needle
14	10	ABG-2040-14-0100	COX-2000-14-0051
14	15	ABG-2040-14-0150	COX-2000-14-0101
14	20	ABG-2040-14-0200	COX-2000-14-0151
16	10	ABG-2040-16-0100	COX-2000-16-0051
16	15	ABG-2040-16-0150	COX-2000-16-0101
16	20	ABG-2040-16-0200	COX-2000-16-0151
18	10	ABG-2040-18-0100	COX-2000-18-0051
18	15	ABG-2040-18-0150	COX-2000-18-0101
18	20	ABG-2040-18-0200	COX-2000-18-0151
18	25	ABG-2040-18-0250	COX-2000-18-0201
20	10	ABG-2040-20-0100	COX-2000-20-0051
20	15	ABG-2040-20-0150	COX-2000-20-0101
20	20	ABG-2040-20-0200	COX-2000-20-0151

SPLIT CANNULA

For suprapubic puncture of the bladder

DESCRIPTION

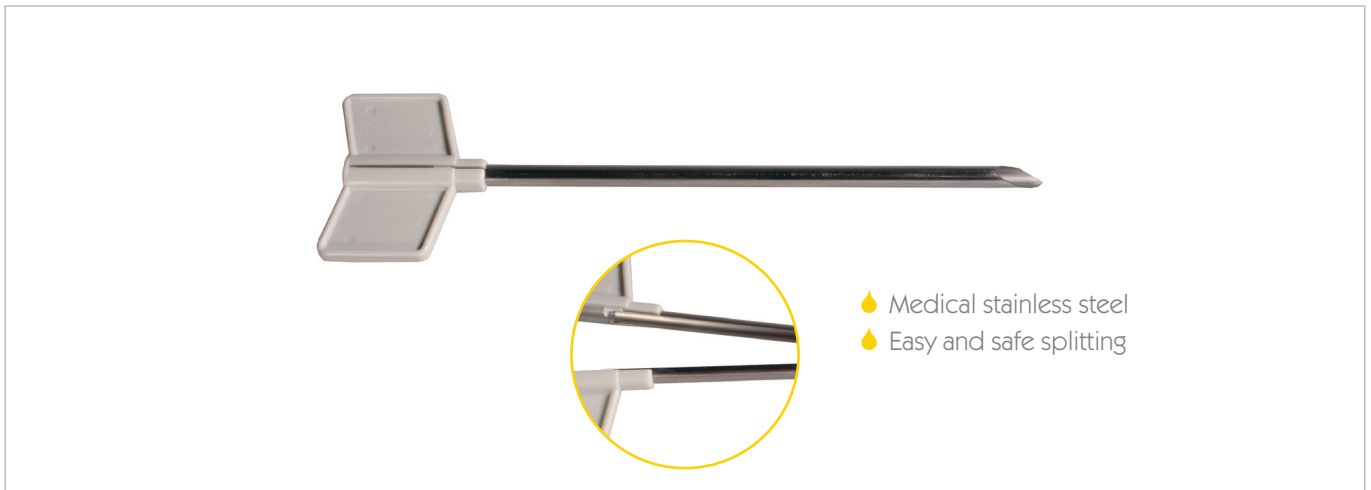

For Catheter (FR/CH)	Inner Ø (mm)	Outer Ø (mm)	Length (cm)	Order Code
8.5	3.15	3.6	08	SU-121008
8.5	3.15	3.6	12	SU-121012
12	4.2	4.6	08	SU-121408
12	4.2	4.6	12	SU-121412*
14	5.2	5.6	12	SU-121512**

Note: not compatible with single catheter SU-271205*, SU-271405** & SU-271425**

RENODRAIN DILATORS

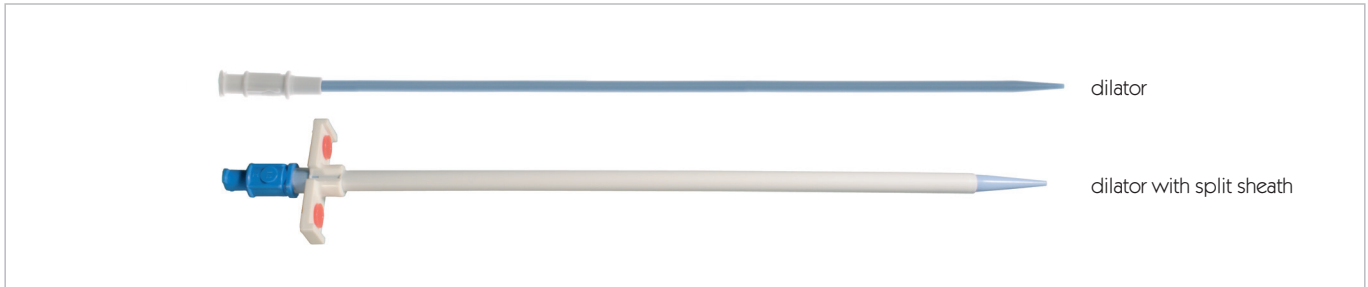

Dilator / Single			
Size (FR/CH)	Length (cm)	Order Code	Maximum Guide Wire Ø
06	18	RE-440618	0.038"
07	18	RE-440718	0.038"
08	18	RE-440818	0.038"
09	18	RE-440918	0.038"
10	18	RE-441018	0.038"
12	18	RE-441218	0.038"
14	18	RE-441418	0.038"
16	18	RE-441618	0.038"
18	18	RE-441818	0.038"

Dilator-Set <small>*split sheath at the biggest dilator</small>			
Size (FR/CH)	Length (cm)	Order Code	Maximum Guide Wire Ø
08/10/12/14/16	18	RE-440525	0.038"
08/10/12/14/16	18	RE-440526*	0.038"
12/14/16/18	18	RE-440626*	0.038"

Dilator with split sheath / Single			
Size (FR/CH)	Length (cm)	Order Code	Maximum Guide Wire Ø
06	18	RE-440602	0.038"
08	18	RE-440802	0.038"
09	18	RE-440902	0.038"
10	18	RE-441002	0.038"
12	18	RE-441202	0.038"
14	18	RE-441402	0.038"
16	18	RE-441602	0.038"
18	18	RE-441802	0.038"

ADAPTER

Adapter with Luer Lock female

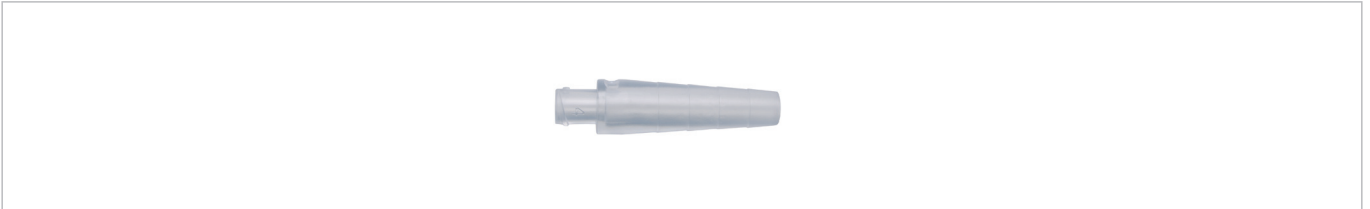

Length (cm)	Order Code Luer Lock female
	KS-114

Adapter with Luer Lock male



Length (cm)	Order Code Luer Lock male
20	RE-450110

Adapter for attachment of the urinary drainage bag



Size (FR/CH)	Order Code Luer Lock female
03	UK-645
4.7	UK-611
06	UK-614
08	UK-618

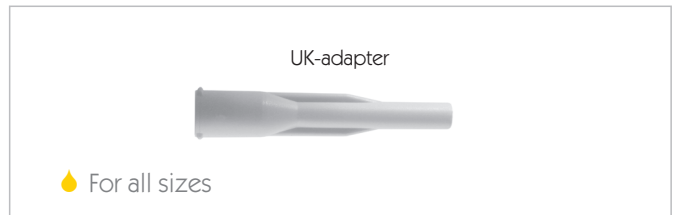

Size (FR/CH)	Order Code Luer Lock female
03-07	UK-ADAPT-3-7

ADAPTER

For UROTECH Ureteral Stents (Mono-J)

Tuohy Borst Adapter



For tube sizes (FR/CH)	Order Code Luer Lock
10+12	TB-101

Tuohy Borst Adapter with funnel

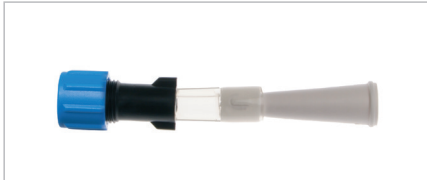

For tube sizes (FR/CH)	Order Code small funnel	Order Code large funnel
06-12	KS-612	KS-613

Needle Adapter

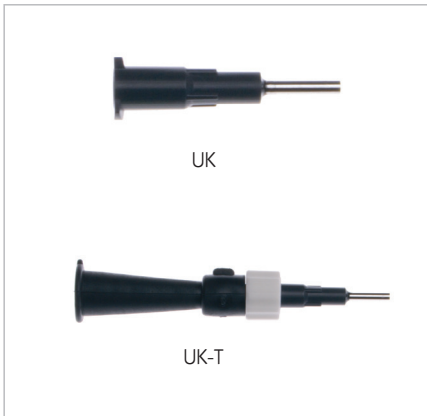

Size (FR/CH)	Order Code Luer Lock female	Order Code with funnel
4.7	UK-610	UK-610-T
06	UK-612	UK-612-T
07	UK-615	UK-615-T
08	UK-618	UK-618-T

SPECIAL ACCESSORIES

Catheter Valves

Order Code

KV-100



For one hand use with automatic stopper

Order Code

443 8477



With stop cock

Urethra Olive

Order Code

CK-001



Catheter Plug

Order Code

KV200



TUOHY BORST ADAPTER

DESCRIPTION

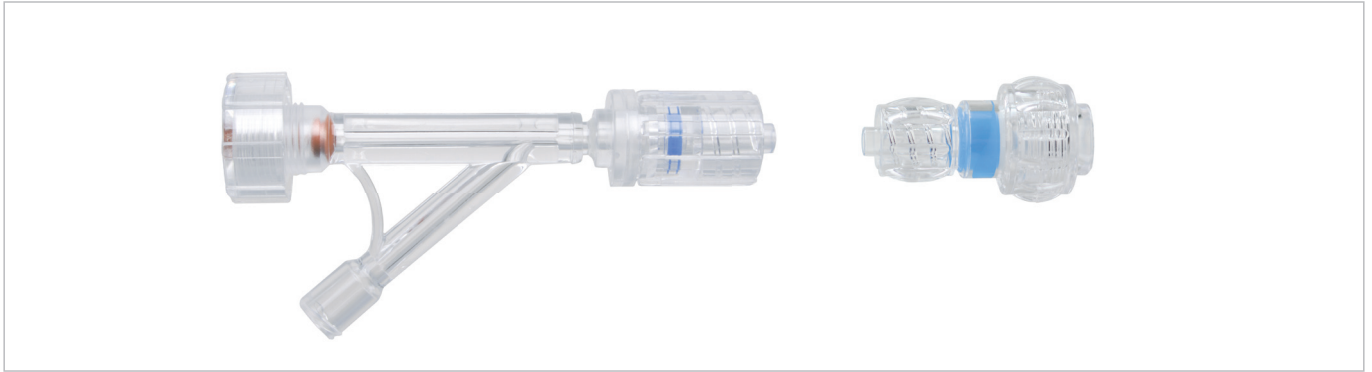

Tuohy Borst Adapter with syringe connector

- ◆ Attachment to catheter, dilator or puncture needle
- ◆ E.g. injection of contrast agent to visualise the renal pelvis without removing the guide wire

Order Code

AYC-010

Tuohy Borst Adapter

- ◆ With male Luer-Lock
- ◆ Usable for endoscopy working channel

Order Code

TBM

URETERAL CATHETERS

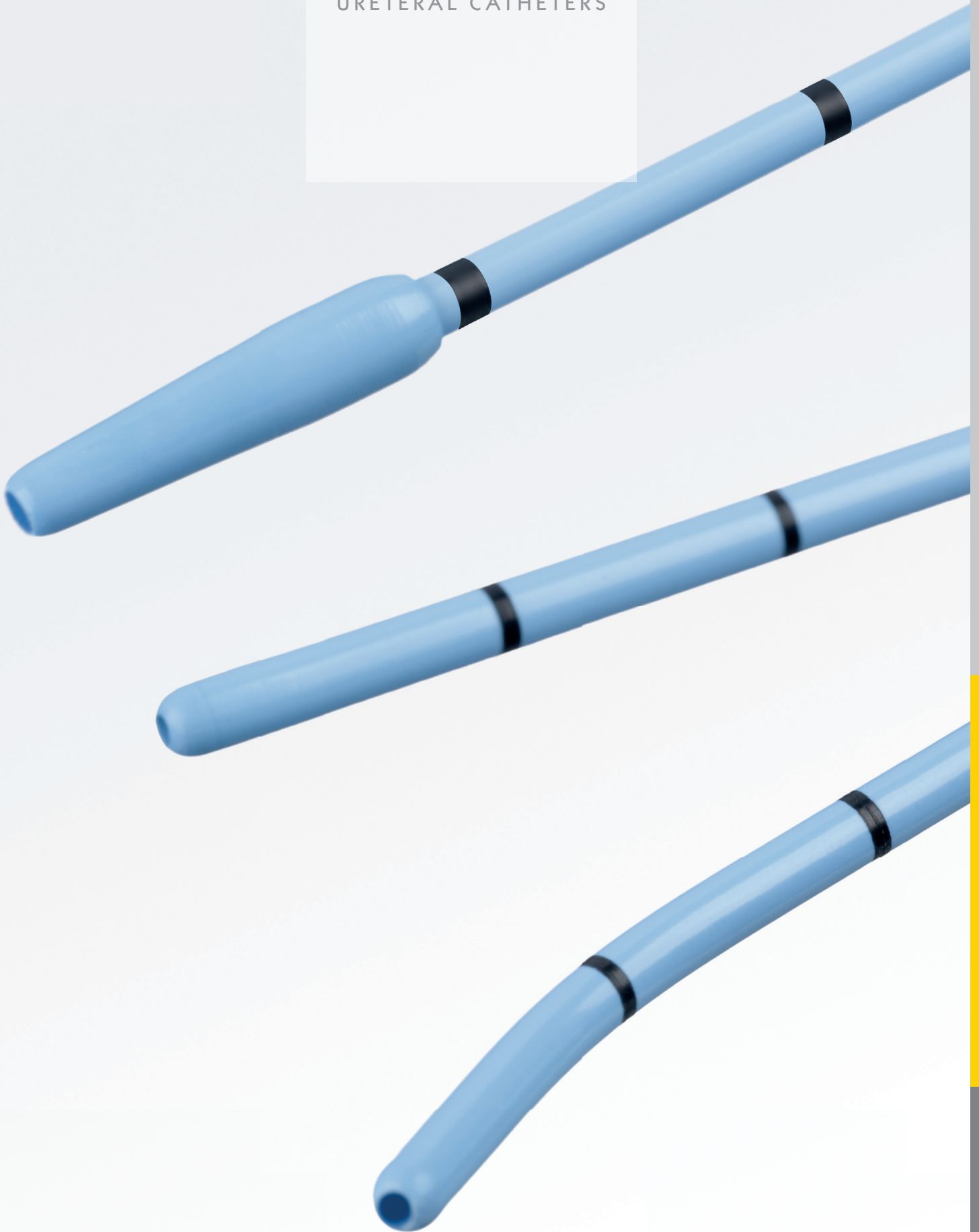

Ureteral Catheters

Foley Catheters

Stone Baskets

Urodynamic

Special Products

Care Products

Pediatric Urology



UROTECH

URETERAL CATHETERS

For the retrograde urography

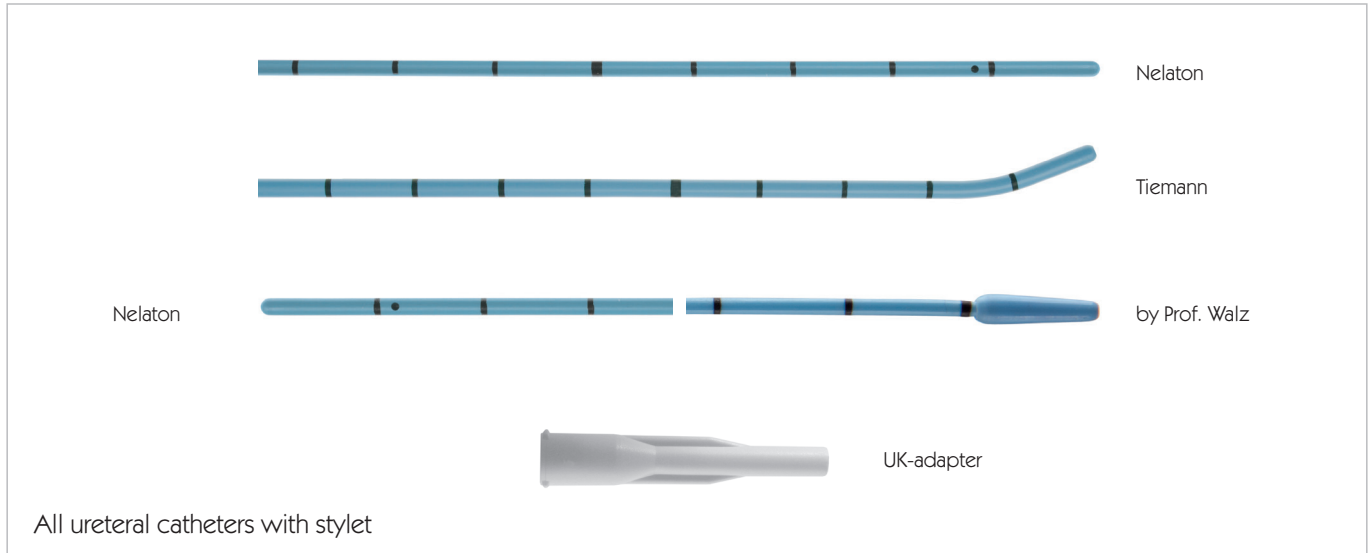

All ureteral catheters with stylet

Nelaton tip				
Size (FR/CH)	Length (cm)	Order Code closed tip	Order Code open tip	Max. Guide Wire Diameter
03	70	UK-500370	UK-600370	
04	70	UK-500470	UK-600470	0.035"
05	70	UK-500570	UK-600570	0.035"
06	70	UK-500670	UK-600670	0.035"
07	70	UK-500770	UK-600770	0.035"

Tiemann tip				
Size (FR/CH)	Length (cm)	Order Code closed tip	Order Code open tip	Max. Guide Wire Diameter
03	70	UK-510370	UK-540370	
04	70	UK-510470	UK-540470	0.035"
05	70	UK-510570	UK-540570	0.035"
06	70	UK-510670	UK-540670	0.035"
07	70	UK-510770	UK-540770	0.035"

Ureteral catheter by Prof. Walz				
Size (FR/CH)	Length (cm)	Tip by Prof. Walz (FR/CH)	Order Code open tip both sides	Max. Guide Wire Diameter
04	70	07	UK-630470	0.035"

URETERAL BALLOON DILATION CATHETER

For retrograde access

DESCRIPTION

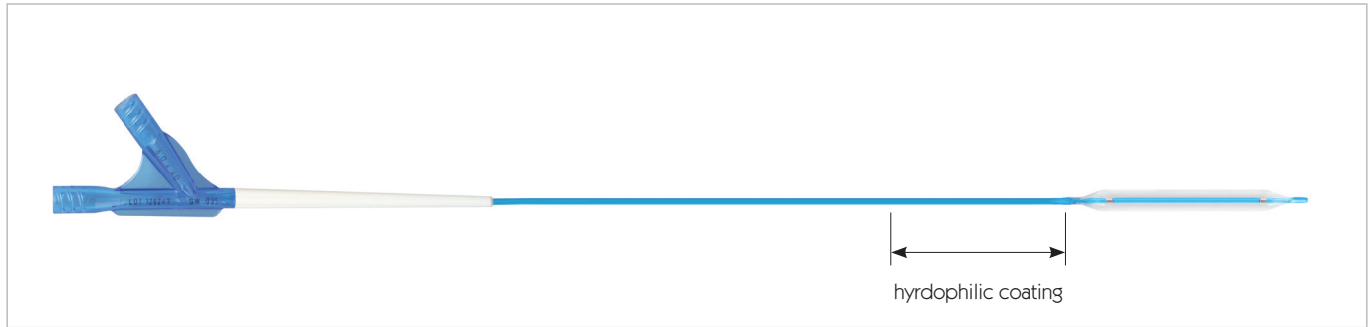

Balloon Dilation Catheter

- ◆ Transluminal dilation of ureteral strictures and dilation of ureter prior to stone management
- ◆ Radiopaque, additional markers at the distal and proximal end of balloon
- ◆ Hydrophilic coating (approx. 25 cm) for easy insertion
- ◆ Luer Lock Connector

Balloon Diameter (mm)	Balloon Length (mm)	Shaft Length (cm)	Nominal Pressure (atm)	RBP (atm)	Guide Wire Comp.	Sheath Comp. (FR)	Order Code
4	40	80	6	16	0.035"	5	UBD - 5440
4	60	80	6	16	0.035"	5	UBD - 5460
4	80	80	6	16	0.035"	5	UBD - 5480
6	40	80	6	16	0.035"	5	UBD - 5640
6	60	80	6	16	0.035"	5	UBD - 5660
6	80	80	6	14	0.035"	5	UBD - 5680
8	40	80	6	14	0.035"	6	UBD - 5840
8	60	80	6	14	0.035"	6	UBD - 5860
8	80	80	6	12	0.035"	6	UBD - 5880

Compliance chart

Inflation Pressure		Balloon Diameter (mm)		
atm / bar	kPA	4.0	6.0	8.0
4	400	3.78	5.68	7.45
6	600	4.00	6.00	8.00
8	800	4.15	6.16	8.31
10	1000	4.28	6.30	8.53
11	1100	4.33	6.37	8.64
12	1200	4.40	6.44	8.77
13	1300	4.46	6.52	8.89
14	1400	4.53	6.59	9.00
15	1500	4.60	6.67	9.12
16	1600	4.67	6.79	9.25
17	1700	4.75	6.84	

Nominal Pressure
 Rated Burst Pressure (RBP) for balloon length 40-60 mm
 Rated Burst Pressure (RBP) for balloon length 80 mm

URETERAL OCCLUSION CATHETER

DESCRIPTION

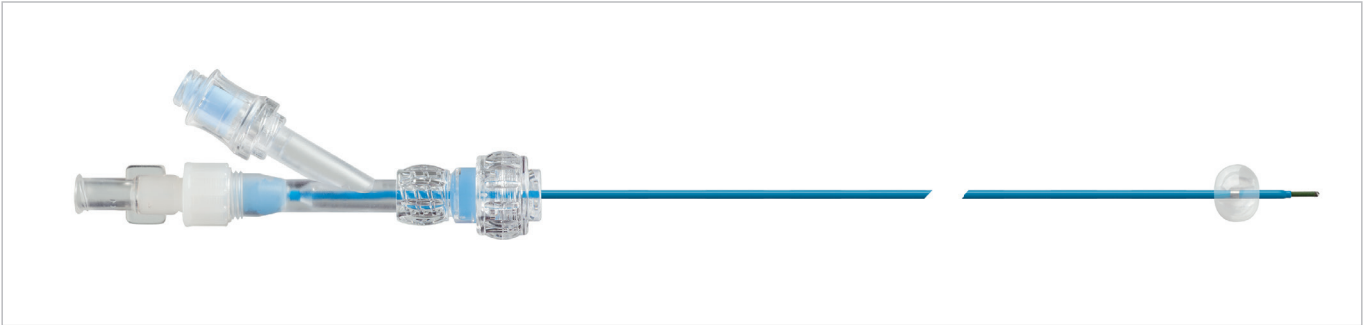

Ureteral Occlusion Catheter

- ◆ Hydrophilic tip for easy positioning
- ◆ Additional radiomarker in the centre of the balloon for safe localisation
- ◆ Smooth junction of catheter tube and balloon
- ◆ Latex free balloon
- ◆ Active deflation of balloon with syringe possible
- ◆ Adjustment of connector

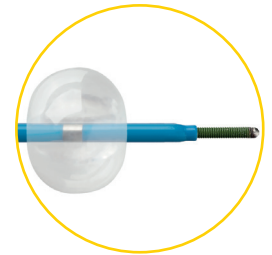

Size Catheter (FR/CH)	Size Tip (FR/CH)	Catheter Length (cm)	Balloon Volume (ml)	Mandril Length (cm)	Mandril Diameter (inch)	Order Code
5.0	4.0	75	1	84	0.035"	OK-05-75

FOLEY CATHETERS



Foley Catheters

Stone Baskets

Urodynamic

Special Products

Care Products

Pediatric Urology



UROTECH

2-WAY BALLOON CATHETER

100% silicone, with bonded balloon

DESCRIPTION

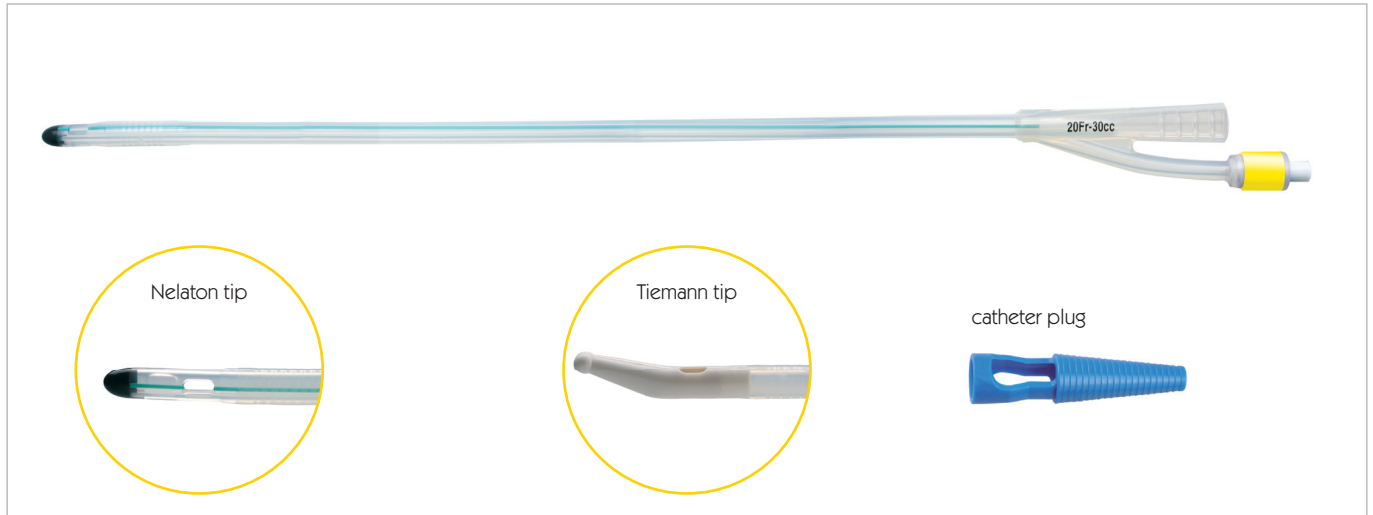

2-Way Balloon Catheter

💧 Silicone for optimal tissue compatibility

Nelaton tip			
Size (FR/CH)	Length (cm)	Balloon Capacity (ml)	Order Code
12	40	10	MA-201205
12	22	10	MA-221210
14	40	10	MA-201405
14	22	10	MA-221410
14	40	20	MA-211430
16	40	10	MA-201605
16	22	10	MA-221610
16	40	30	MA-211630
18	40	10	MA-201805
18	22	10	MA-221810
18	40	30	MA-211830
20	40	10	MA-202005
20	22	10	MA-222010
20	40	30	MA-212030
22	40	10	MA-202205
22	22	10	MA-222210
22	40	30	MA-212230
24	40	10	MA-202405
24	40	30	MA-212430
26	40	10	MA-202605

Tiemann tip			
Size (FR/CH)	Length (cm)	Balloon Capacity (ml)	Order Code
10	31	05	MA-301010
12	40	05	MA-301210
14	40	05	MA-301410
16	40	10	MA-301610
18	40	10	MA-301810
20	40	10	MA-302010
22	40	10	MA-302210

2-WAY BALLOON CATHETER

100% silicone, Standard and Supersoft

DESCRIPTION

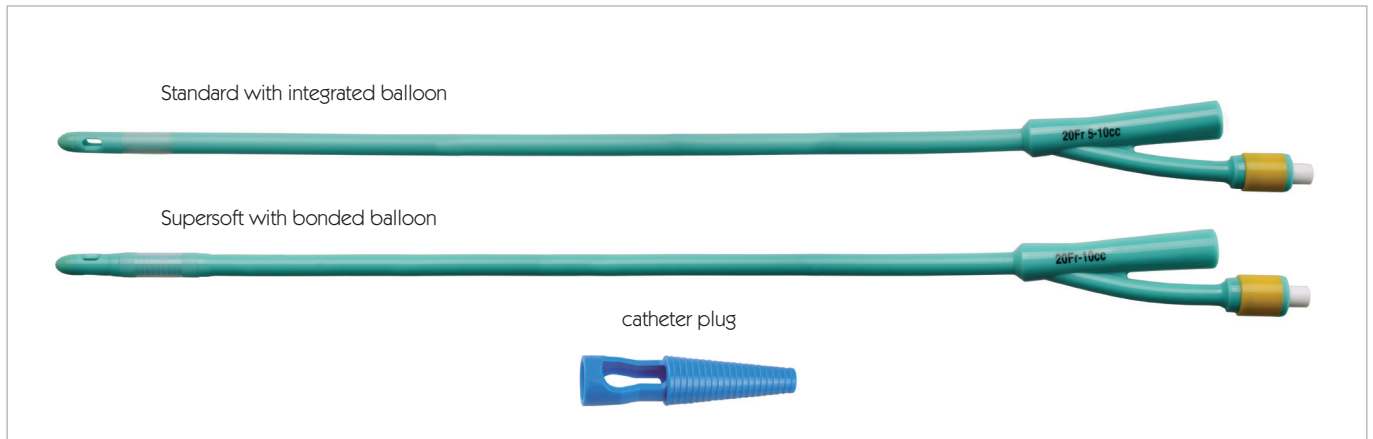

2-Way Balloon Catheter

💡 Silicone for optimal tissue compatibility

Standard			
Size (FR/CH)	Length (cm)	Balloon Capacity (ml)	Order Code
12	40	05	GR-701210
14	40	05	GR-701410
16	40	05-10	GR-701610
18	40	05-10	GR-701810
20	40	05-10	GR-702010
22	40	05-10	GR-702210
24	40	05-10	GR-702410
26	40	05-10	GR-702610

Supersoft			
Size (FR/CH)	Length (cm)	Balloon Capacity (ml)	Order Code
12	40	05	GR-601210
14	40	05	GR-601410
16	40	05	GR-601610
18	40	05	GR-601810
20	40	05	GR-602010
22	40	05	GR-602210
24	40	05	GR-602410
26	40	05	GR-602610

3-WAY BALLOON CATHETER Postoperative irrigation

100% silicone, with bonded balloon

DESCRIPTION

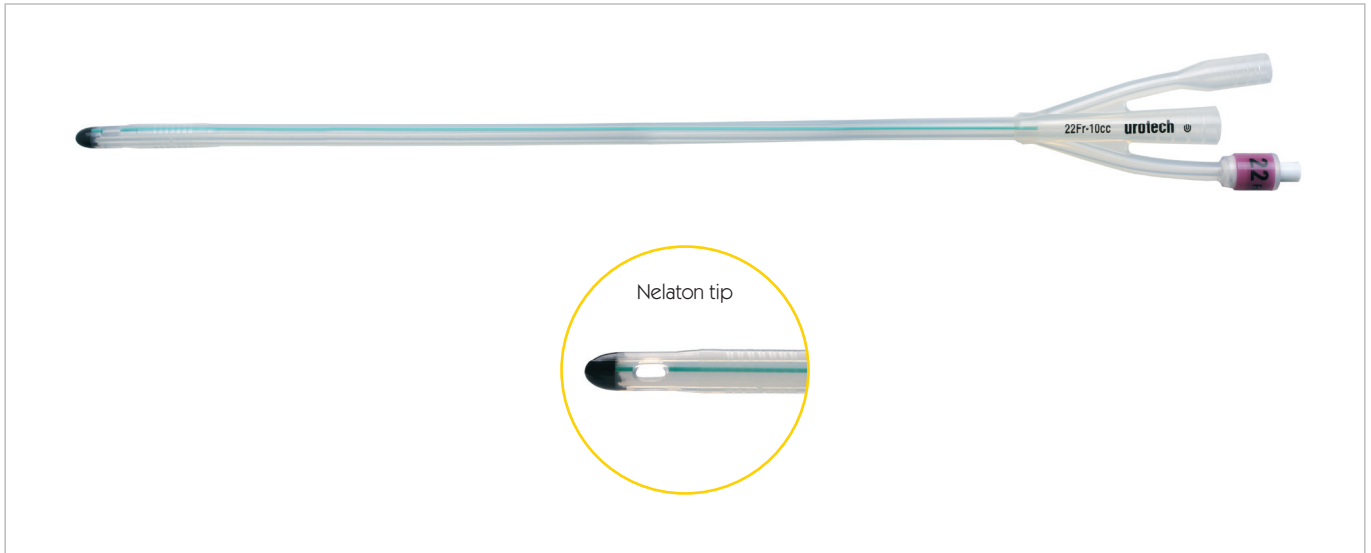

3-Way Balloon Catheter

💧 Silicone for optimal tissue compatibility

Nelaton tip			
Size (FR/CH)	Length (cm)	Balloon Capacity (ml)	Order Code
16	40	10	MA-231605
18	40	10	MA-231805
18	40	30	MA-241830
20	40	10	MA-232005
20	40	30	MA-242030
22	40	10	MA-232205
22	40	30	MA-242230
24	40	30	MA-242430

3-WAY BALLOON CATHETER

Postoperative irrigation and tamponade
100% silicone, with bonded balloon

DESCRIPTION



3-Way Balloon Catheter

- ◆ Silicone for optimal tissue compatibility
- ◆ Large balloon capacity for strong compression and effective haemostasis
- ◆ Very high drainage capacity

Dufour tip			
Size (FR)	Length (cm)	Balloon Capacity (ml)	Order Codes
16	42	40	MA-521640
18	42	50	MA-521850
20	42	60	MA-522060
22	42	70	MA-522270
24	42	80	MA-522480

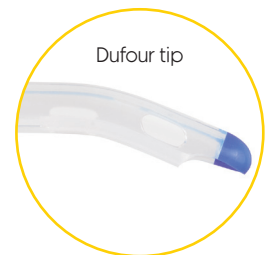

Couvelaire tip			
Size (FR)	Length (cm)	Balloon Capacity (ml)	Order Codes
16	42	40	MA-501640
18	42	50	MA-501850
20	42	60	MA-502060
22	42	70	MA-502270
24	42	80	MA-502480



Mercier tip			
Size (FR)	Length (cm)	Balloon Capacity (ml)	Order Codes
16	42	40	MA-561640
18	42	50	MA-561850
20	42	60	MA-562060
22	42	70	MA-562270
24	42	80	MA-562480

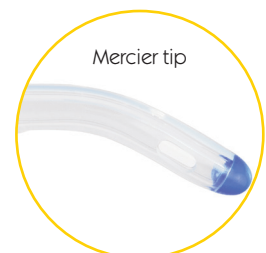

STONE BASKETS

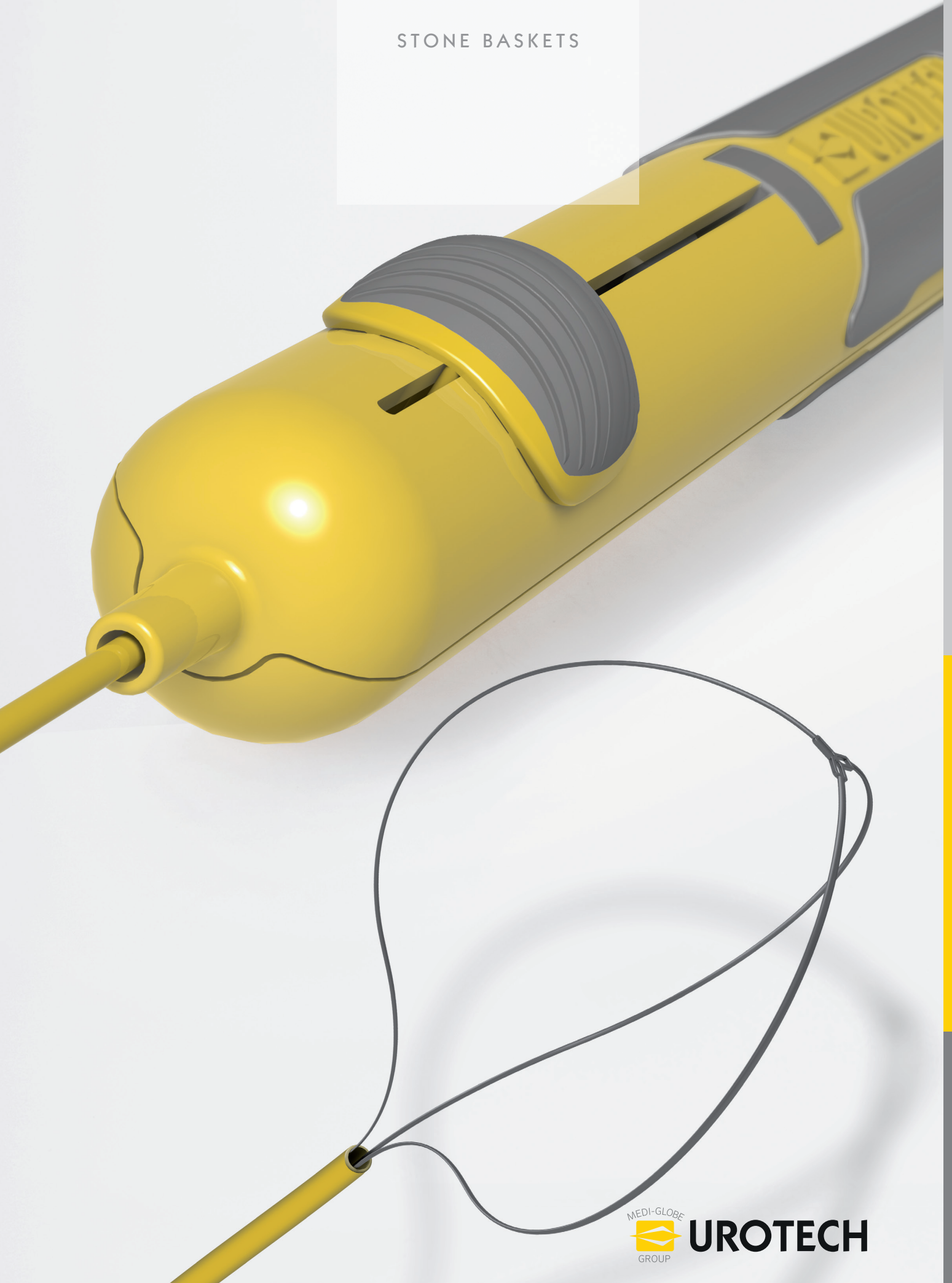

STONE BASKETS

High elastic Nitinol material, with detachable handle acc. to Lahme

“TIPLESS”



- ♦ Delicate 3-, 4- or 6-wire-baskets without tip for the flexible uretero-rensoscopy
- ♦ For grasping of smallest stone concretments also on tissue edge
- ♦ With Tuohy Borst Adapter to protect the basket tip

Size (FR/CH)	Wires	Working Length (cm)	Basket Length (mm)	Basket Ø (mm)	Basket Shape	Order Code
1.2	3	120	12	8	straight	STN-T123-120
1.8	4	120	15	11	straight	STN-T184-120
1.8	4	120	15	11	helical	STN-HT184-120
1.8	6	120	13	9	straight	STN-T186-120
2.2	4	120	18	11	straight	STN-T224-120

Handle acc. to Lahme for all stone baskets

- ♦ Dis- and reconnectable handle: endoscope can be removed while basket is situated. Handle and basket can get attached afterwards
- ♦ Fixation of the stone in the basket due to spring mechanism
- ♦ Ergonomic handle design with non-slip surface
- ♦ Basket opens and closes within image area: no adjustment of endoscope necessary

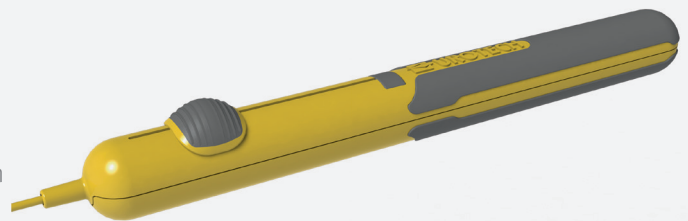

STONE BASKETS

“HELICAL”

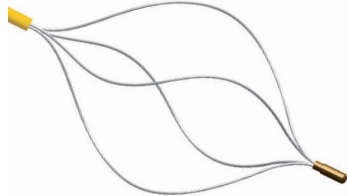

Size (FR/CH)	Wires	Working Length (cm)	Basket Length (mm)	Basket Ø (mm)	Tip length (mm)	Order Code
2.5	4	90	30	12	3	STN-L254-090
2.5	4	120	30	12	3	STN-L254-120
3.0	4	90	31	12	3	STN-L304-090
3.0	4	120	31	12	3	STN-L304-120
4.0	4	90	37	15	3	STN-L404-090

“FILIFORM”



Size (FR/CH)	Wires	Working Length (cm)	Basket Length (mm)	Basket Ø (mm)	Tip length (mm)	Order Code
3.0	4	90	30	12	40	STN-F304-090

“STRAIGHT”

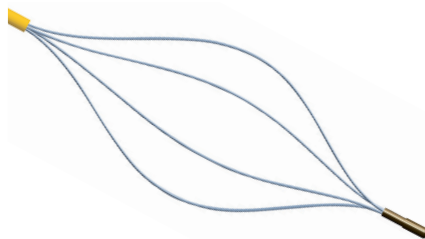

Size (FR/CH)	Wires	Working Length (cm)	Basket Length (mm)	Basket Ø (mm)	Tip length (mm)	Order Code
2.5	4	120	30	12	3	STN-G254-120
3.0	4	120	31	12	3	STN-G304-120

URODYNAMIC



UROTECH

MEASUREMENT CATHETER

For cystometry and UPP measurement

Triple lumen catheter

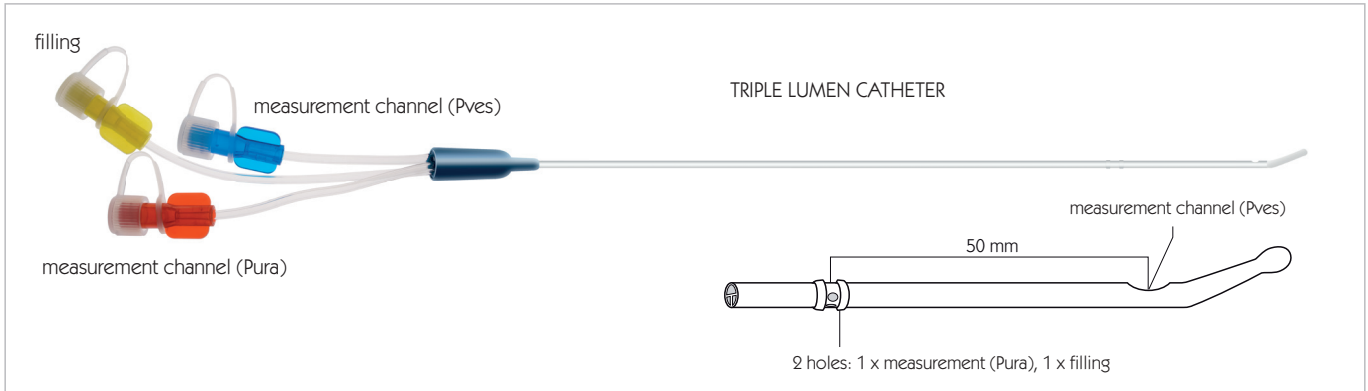

Size (FR/CH)	Length (cm)	Order Code Nelaton tip	Order Code Tiemann tip
09	40	UD-M309400N	UD-M309400T

Double lumen catheter

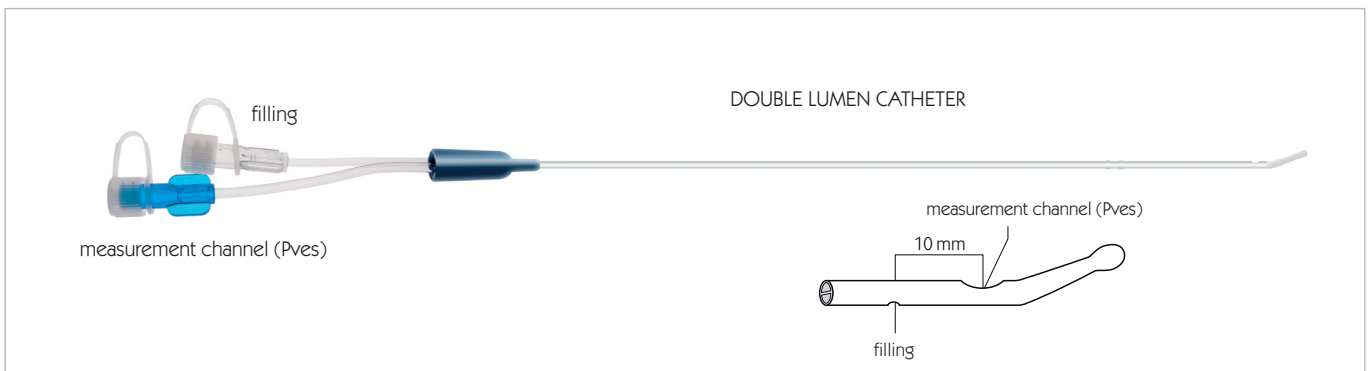

Size (FR/CH)	Length (cm)	Order Code Nelaton tip	Order Code Tiemann tip
08	40	UD-M208400N	UD-M208400T
10	40	UD-M210400N	UD-M210400T

RECTAL PRESSURE CATHETERS

Double lumen catheter with silicone balloon



Size (FR/CH)	Length (cm)	Balloon Diameter (mm)	Balloon Length (mm)	Order Code
09	20	07	20	UD-R209200
12	30	15	70	UD-R212300S

Double lumen catheter with latex balloon



Size (FR/CH)	Length (cm)	Balloon Diameter (mm)	Balloon Length (mm)	Order Code
12	30	15	55	UD-R212300L

Single lumen catheter with latex balloon



Size (FR/CH)	Length (cm)	Balloon Diameter (mm)	Balloon Length (mm)	Order Code
12	40	11	55	UD-R112400

ACCESSORIES

Three-part extension set

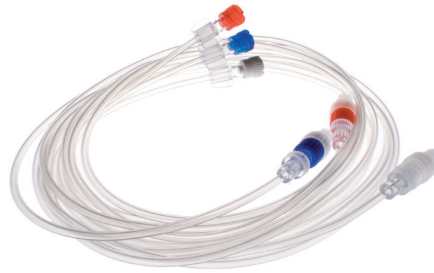

Inner Diameter (mm)	Length (cm)	Order Code
1.5	150	UD-Z31500

Two-part extension set

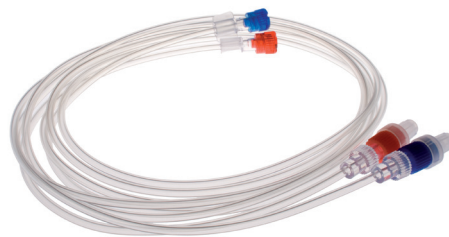

Inner Diameter (mm)	Length (cm)	Order Code
1.5	150	UD-Z21500

Infusion tubing



Soft pump section made of silicone

Length (cm)	Order Code
300	UD-Z3000

CONNECTION OF THE CATHETER

Connection of the triple lumen measurement catheter

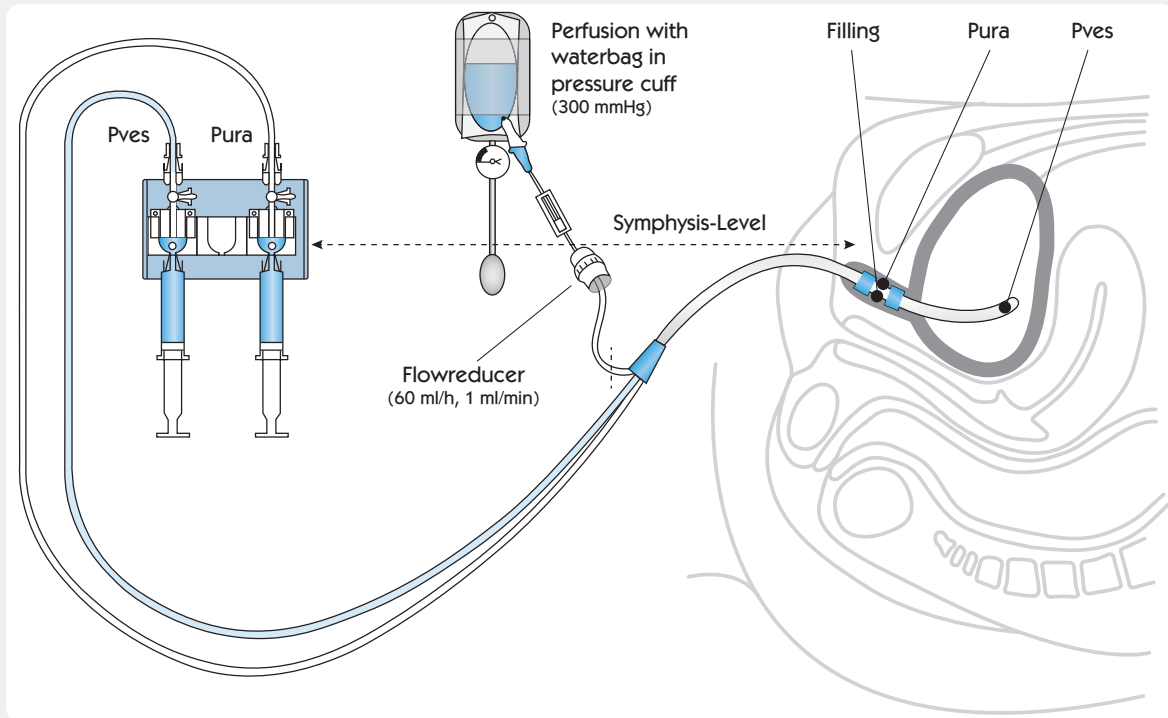

Connection of the double lumen measurement catheter and rectal pressure catheter

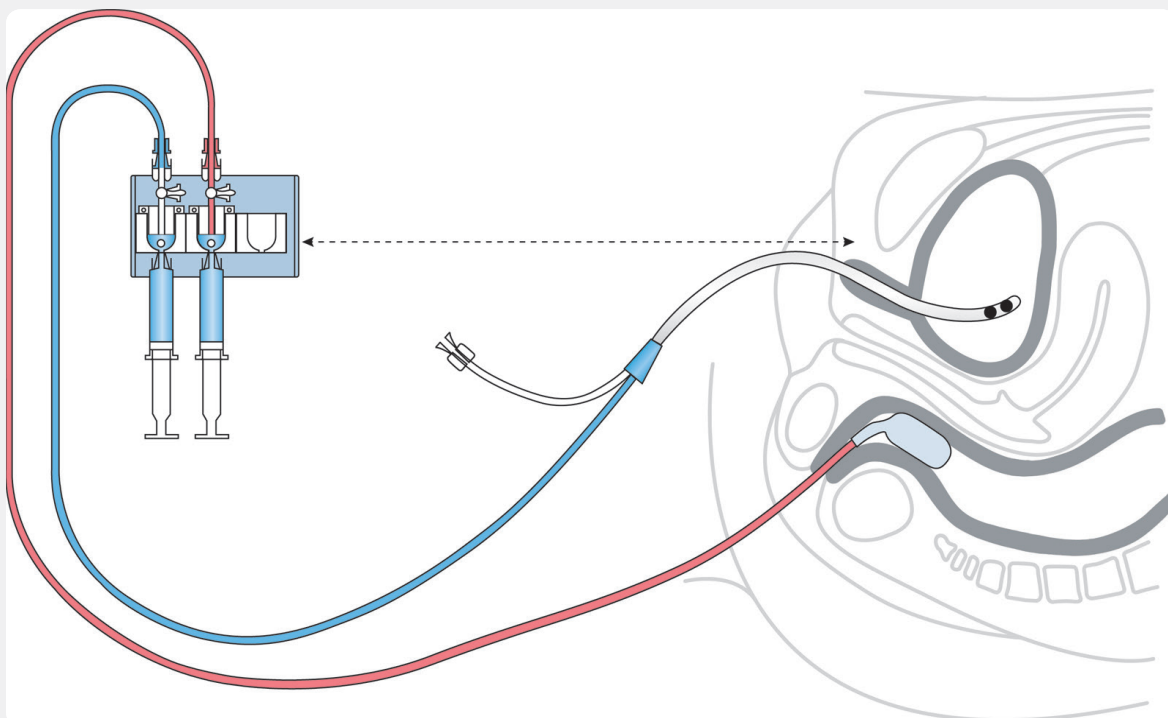

SPECIAL PRODUCTS



URETERAL ACCESS SHEATH

With atraumatic tip-transition

DESCRIPTION

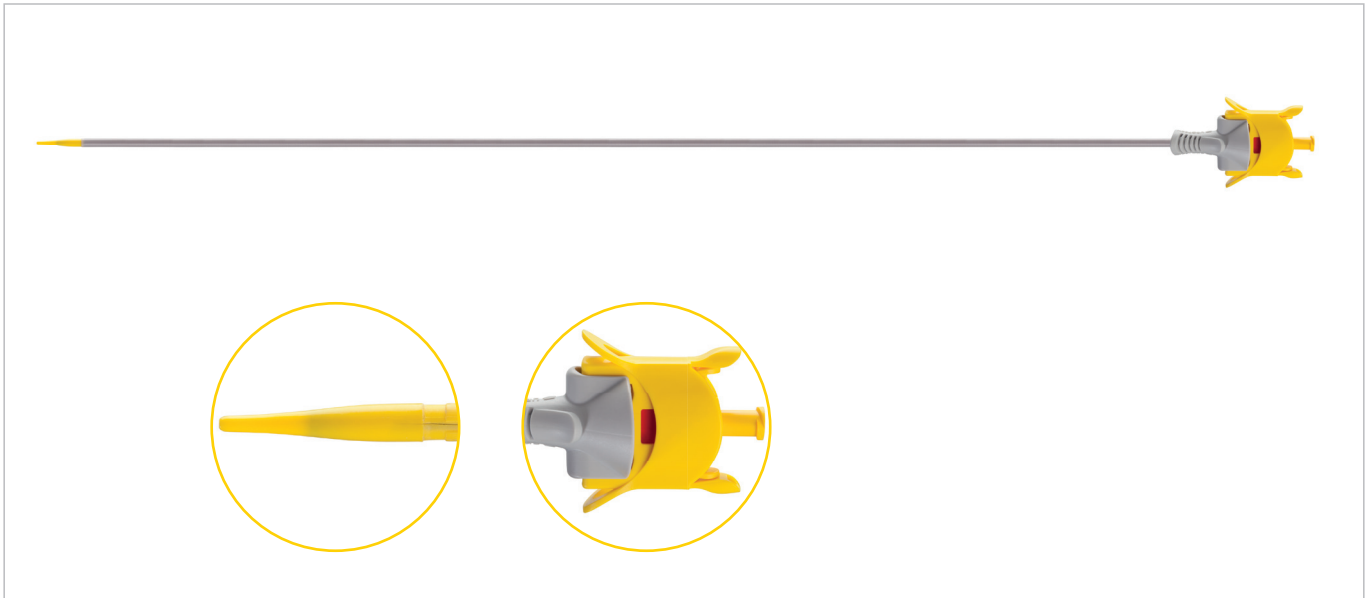

Ureteral Access Sheath

- ◆ Unique tip expanding system for atraumatic sheath transition
- ◆ Dilator lock system for secure connection between sheath and dilator
- ◆ Visual control of dilator fixation
- ◆ PTFE inner layer which provides smooth device passage
- ◆ Radiopaque sheath and dilator tip for easy positioning
- ◆ Hydrophilic coating to facilitate the introduction
- ◆ Stainless-steel coil reinforcement sheath which provides high anti-kink characteristics

Tube Length (cm)	Inner Diameter (CH/FR)	Outer Diameter (CH/FR)	Order Code
35	10	12	AS-1235
45	10	12	AS-1245
35	12	14	AS-1435
45	12	14	AS-1445
35	14	16	AS-1635
45	14	16	AS-1645

VISIOKON-CATHETER

100% silicone, for radiopaque visualisation of the female urethra

DESCRIPTION

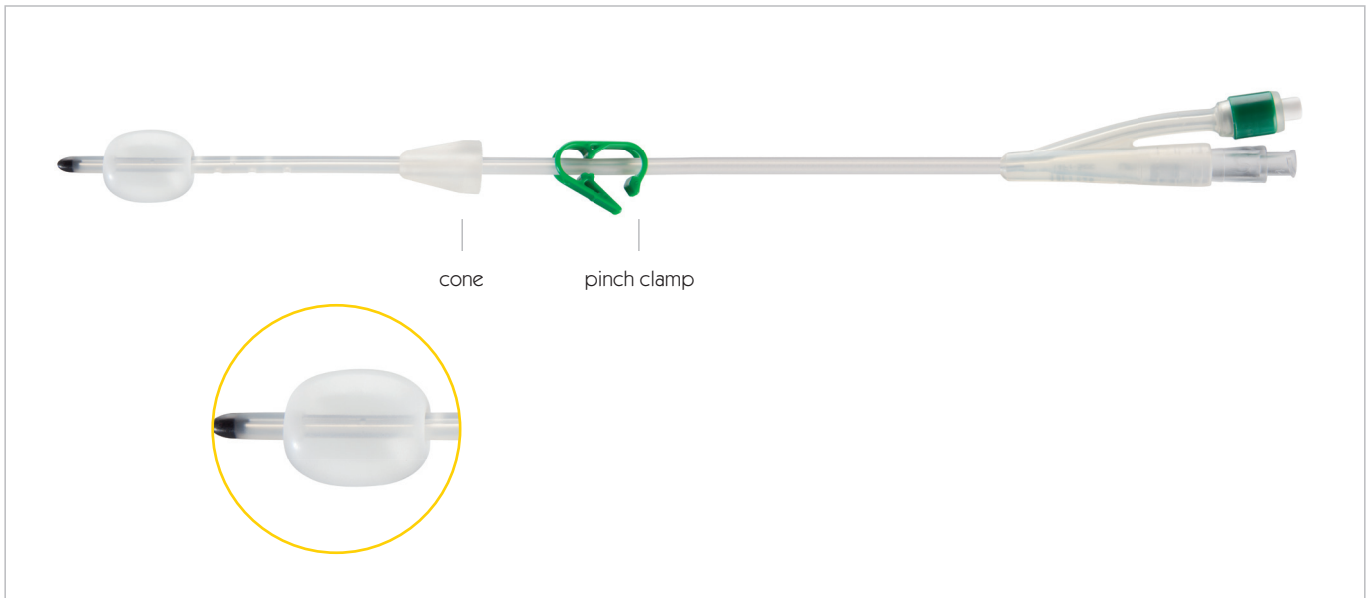

Catheter with Cone and Pinch Clamp

- ◆ Silicone for optimal tissue compatibility
- ◆ Cone made of 100% silicone to close the urethra
- ◆ Pinch clamp to secure the cone
- ◆ Catheter and conus Parylene-coated for better gliding characteristics

Size (FR/CH)	Length (cm)	Balloon Capacity (ml)	Order Code
14	40	10	PI-230

PYELOPLASTY CATHETER

For renal pelvis plastic

SET COMPONENTS

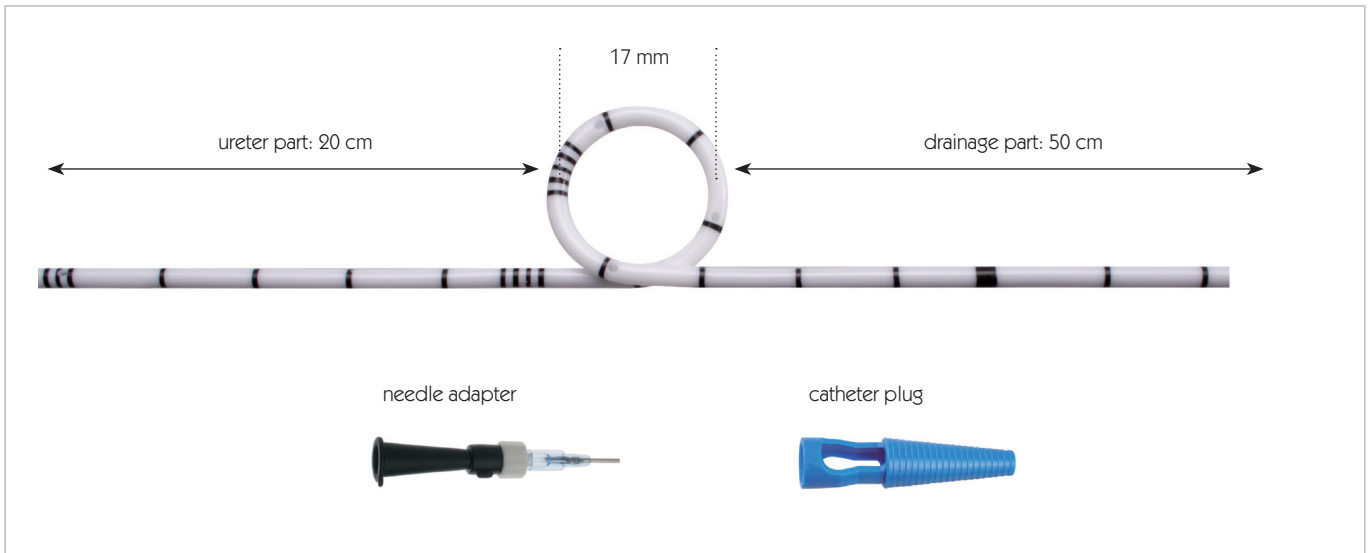

Pyeloplasty Catheter

- ◆ Polyurethane (PUR)
- ◆ Drainage openings in pigtail and in ureter part
- ◆ Markings for exact positioning
- ◆ Radiopaque

Needle Adapter

- ◆ For attachment of the urinary drainage bag

Size (FR/CH)	Length (cm)	Order Code	Max. Guide Wire Diameter
04	20 / 50	EK-610476	0.025"
05	20 / 50	EK-610576	0.028"
06	20 / 50	EK-610676	0.035"
07	20 / 50	EK-610776	0.035"
08	20 / 50	EK-610876	0.038"
09	20 / 50	EK-610976	0.038"

FLEXIBLE INJECTION NEEDLE

For injection of Bulking Agents

DESCRIPTION



Flexible Injection Needle (Injectra)

- ◆ Safe needle guidance and needlestick protection due to interlocking mechanism
- ◆ Ergonomic handle
- ◆ Medical stainless steel needle with 15° grinding insures optimal puncture characteristics

Size (FR/CH)	Needle Diameter (G)	Needle Length (mm)	Working length (cm)	Order Code
06	22	04	66	FIN-57-066

FLEXIBLE INJECTION NEEDLE

For injection of Bulking Agents

DESCRIPTION

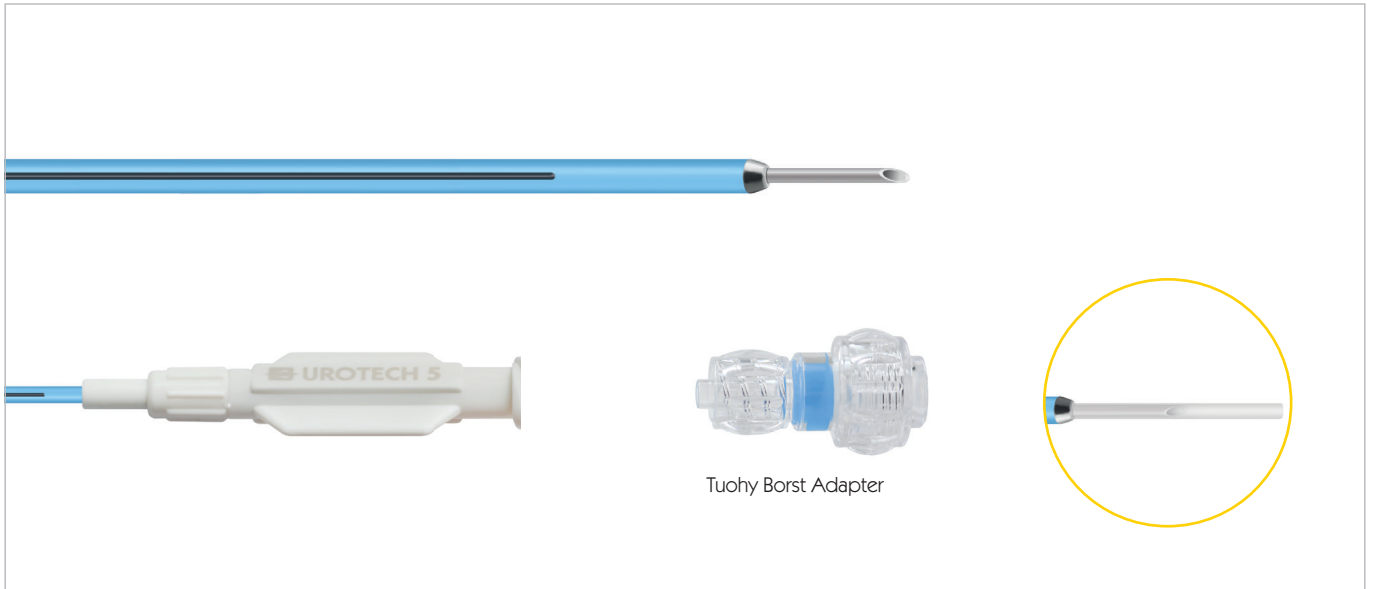

Short flexible Needle

- ◆ Tuohy Borst Adapter for fixation on cystoscope working channel and for splash protection
- ◆ Easy and continuous orientation of needle position (grinding) via marking line

Size (FR/CH)	Needle Diameter (G)	Needle Length (mm)	Working length (cm)	Order Code
Flexible Needle (cylinder clearance 0,9 ml)				
05	23	08	38	FIN-05-380
06	21	08	38	FIN-06-380
Flexible Needle (cylinder clearance 0,9 ml) with Tuohy Borst Adapter				
05	23	08	36	FIN-TB-05-360
06	21	08	36	FIN-TB-06-360

FISTOFIX Renal Cyst Puncture Set

One-step technique, tip with pigtail

SET COMPONENTS

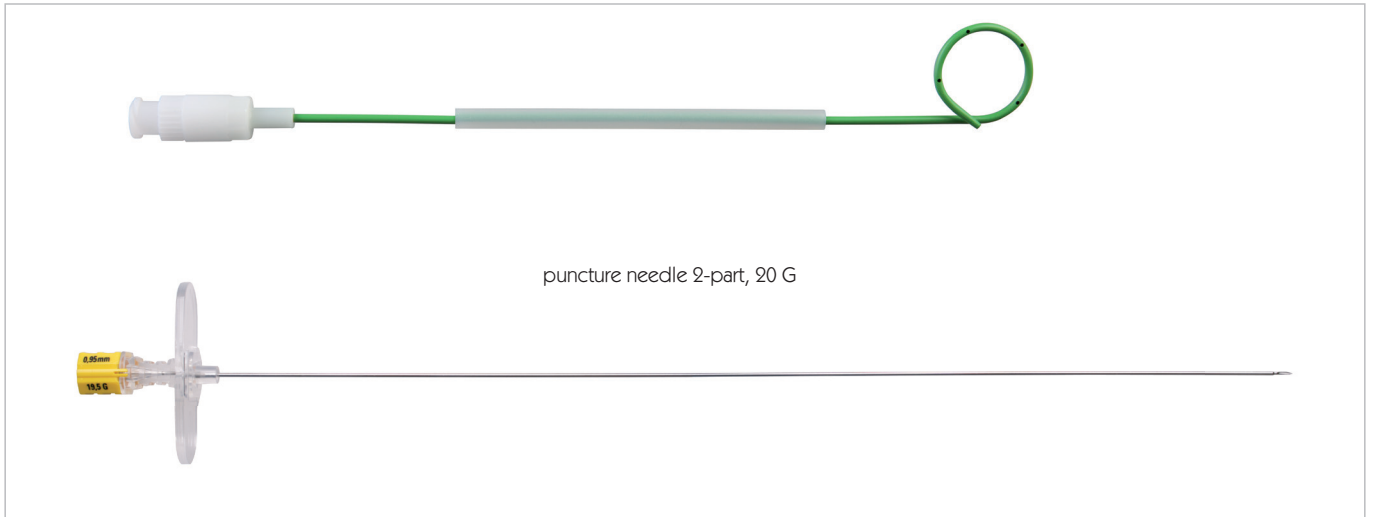

Catheter

- Tube to support insertion of puncture needle (pigtail catheter)
- Straight catheter is pre-assembled on needle

Puncture Needle

- Ultrasonic visible

Puncture Set with pigtail Catheter			
Size (FR/CH)	Length (cm)	Order Code	Length puncture needle (cm)
05	25	ZY-800625	26

PEDIATRIC UROLOGY



LINZER CATHETER-SET Hypospadias and Epispadias

SET COMPONENTS

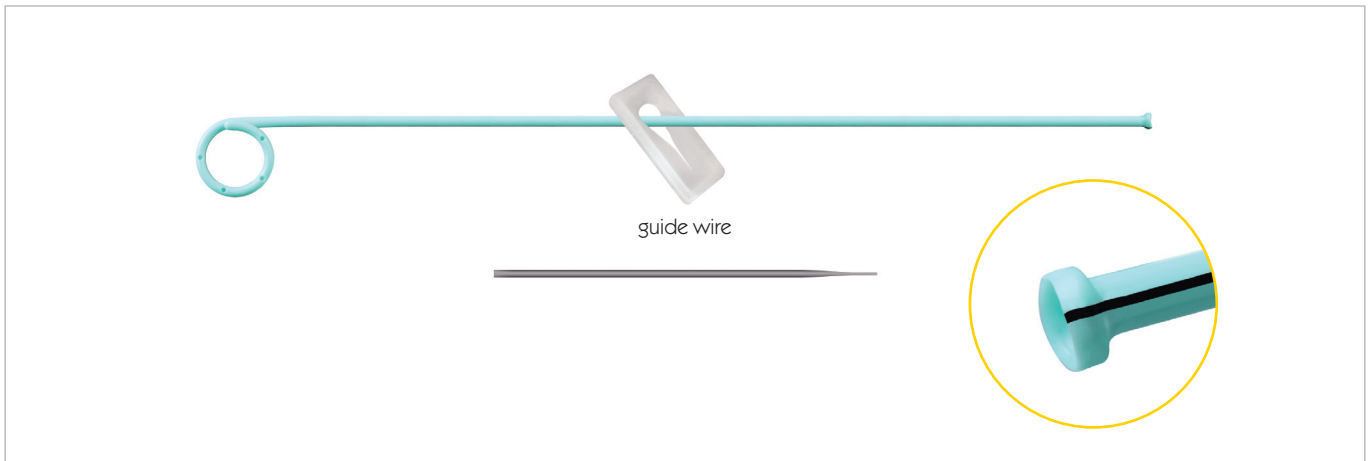

Urethral Catheter

- ◆ Polyurethane (PUR)
- ◆ Stenting of the urethra after hypospadias and epispadias
- ◆ Provides drainage of the bladder after treatment
- ◆ Stabilises the urethra without sutures

Guide Wire

- ◆ PTFE-coated

Closed tip						
Size (FR/CH)	Length (cm)	Order Code	Guide Wire Length (cm)	Guide Wire Diameter	Guide Wire Tip	Guide Wire Stiffness
8	22	EG-350822	40	0.038"	straight	standard

YELLOW-STAR Double-J Ureteral Stent-Set Treated with PC

SET COMPONENTS

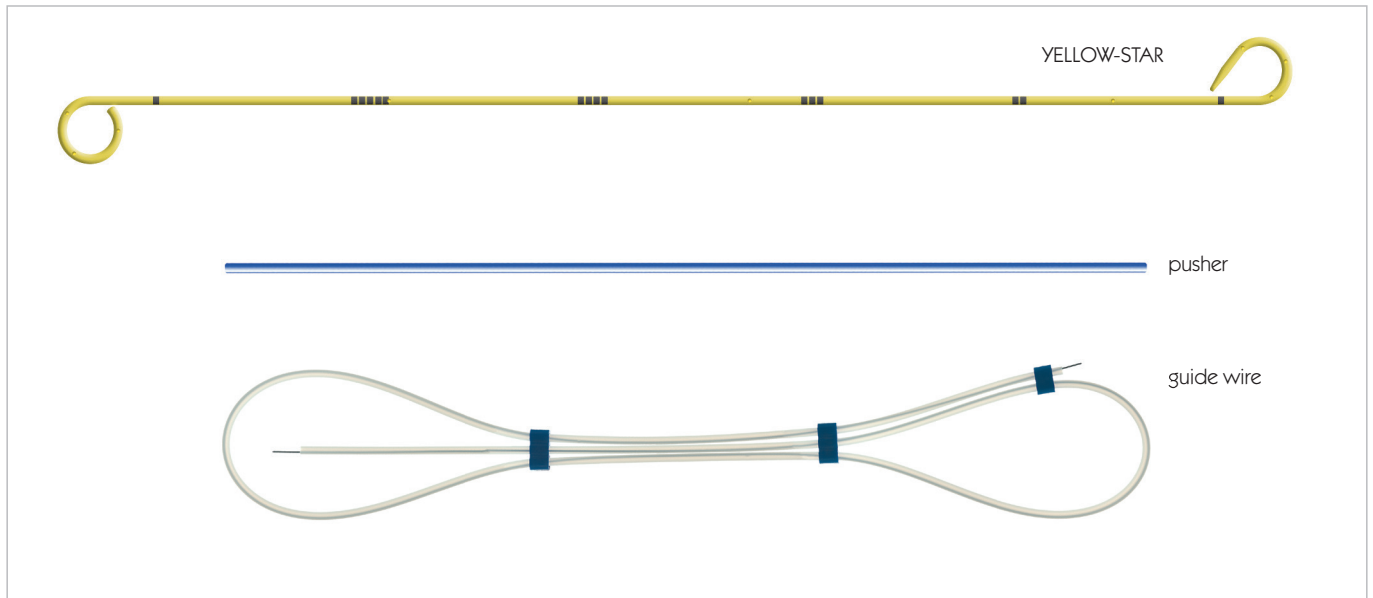

Ureteral Stent

- ◆ Polyurethane (PUR)
- ◆ PC-treatment to minimise risk of infection and encrustation, resulting in extended indwelling time
- ◆ Drainage openings in pigtails and shaft
- ◆ Open or closed tip
- ◆ Markings for exact positioning
- ◆ Radiopaque

Pusher

- ◆ Length: 40 cm

Guide Wire

- ◆ PTFE-coated

Clamp

- ◆ Only in sets with closed tip



YELLOW-STAR Double-J Ureteral Stent Set

Treated with PC

Open tip							
Size (FR/CH)	Length (cm)	Order Code without Guide Wire	Order Code with Guide Wire	Guide Wire Length (cm)	Guide Wire Diameter	Guide Wire Tip	Guide Wire Stiffness
4.7	10	EP-414710	EP-364710	125	0.028"	straight	standard
4.7	12	EP-414712	EP-364712	125	0.028"	straight	standard
4.7	15	EP-414715	EP-364715	125	0.028"	straight	standard
4.7	18	EP-414718	EP-364718	125	0.028"	straight	standard
4.7	20	EP-414720	EP-364720	125	0.028"	straight	standard
4.7	22	EP-414722	EP-364722	125	0.028"	straight	standard

Closed tip							
Size (FR/CH)	Length (cm)	Order Code with Guide Wire	Guide Wire Length (cm)	Guide Wire Diameter	Guide Wire Tip	Guide Wire Stiffness	
4.7	10	EP-394710	125	0.028"	straight	standard	
4.7	12	EP-394712	125	0.028"	straight	standard	
4.7	15	EP-394715	125	0.028"	straight	standard	
4.7	18	EP-394718	125	0.028"	straight	standard	
4.7	20	EP-394720	125	0.028"	straight	standard	

WHITE-STAR Double-J Ureteral Stent Set

SET COMPONENTS

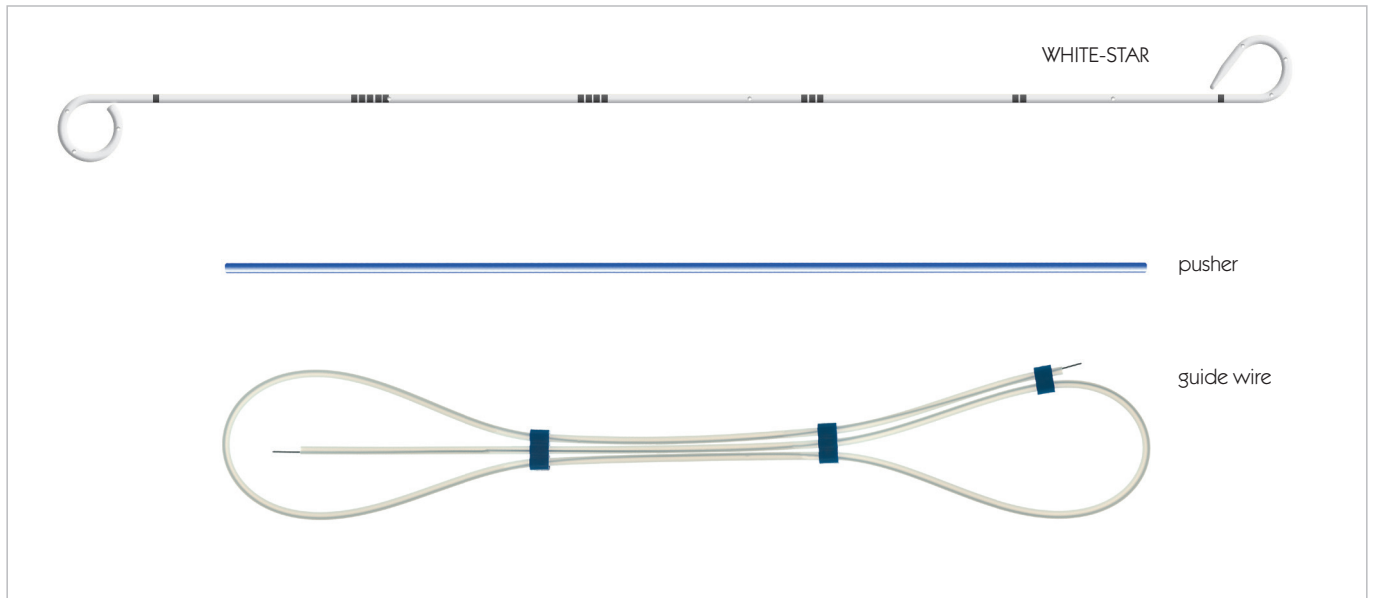

Ureteral Stent

- ◆ Polyurethane (PUR)
- ◆ Drainage openings in pigtails and shaft
- ◆ Open or closed tip
- ◆ Markings for exact positioning
- ◆ Radiopaque

Pusher

- ◆ Length: 40 cm

Guide Wire

- ◆ PTFE-coated

Clamp

- ◆ 2 clamps in sets with closed tip



WHITE-STAR Double-J Ureteral Stent Set

Open tip							
Size (FR/CH)	Length (cm)	Order Code without Guide Wire	Order Code with Guide Wire	Guide Wire Length (cm)	Guide Wire Diameter	Guide Wire Tip	Guide Wire Stiffness
04	08	EN-410408	EN-360408	125	0.025"	straight	standard
04	10	EN-410410	EN-360410	125	0.025"	straight	standard
04	12	EN-410412	EN-360412	125	0.025"	straight	standard
04	15	EN-410415	EN-360415	125	0.025"	straight	standard
04	18	EN-410418	EN-360418	125	0.025"	straight	standard
04	20	EN-410420	EN-360420	125	0.025"	straight	standard
04	22	EN-410422	EN-360422	125	0.025"	straight	standard
4.7	20	EN-410520	EN-360520	125	0.028"	straight	standard
4.7	22	EN-410522	EN-360522	125	0.028"	straight	standard

Closed tip							
Size (FR/CH)	Length (cm)	Order Code with Guide Wire	Guide Wire Length (cm)	Guide Wire Diameter	Guide Wire Tip	Guide Wire Stiffness	
04	08	EN-300408	125	0.025"	straight	standard	
04	10	EN-300410	125	0.025"	straight	standard	
04	12	EN-300412	125	0.025"	straight	standard	
04	15	EN-300415	125	0.025"	straight	standard	
04	18	EN-300418	125	0.025"	straight	standard	
04	20	EN-300420	125	0.025"	straight	standard	
04	22	EN-300422	125	0.025"	straight	standard	
4.7	20	EN-300520	125	0.028"	straight	standard	
4.7	22	EN-300522	125	0.028"	straight	standard	

MAGNETIC BLACK-STAR Double-J Ureteral Stent-Set and Retrieval Device with magnet

SET COMPONENTS

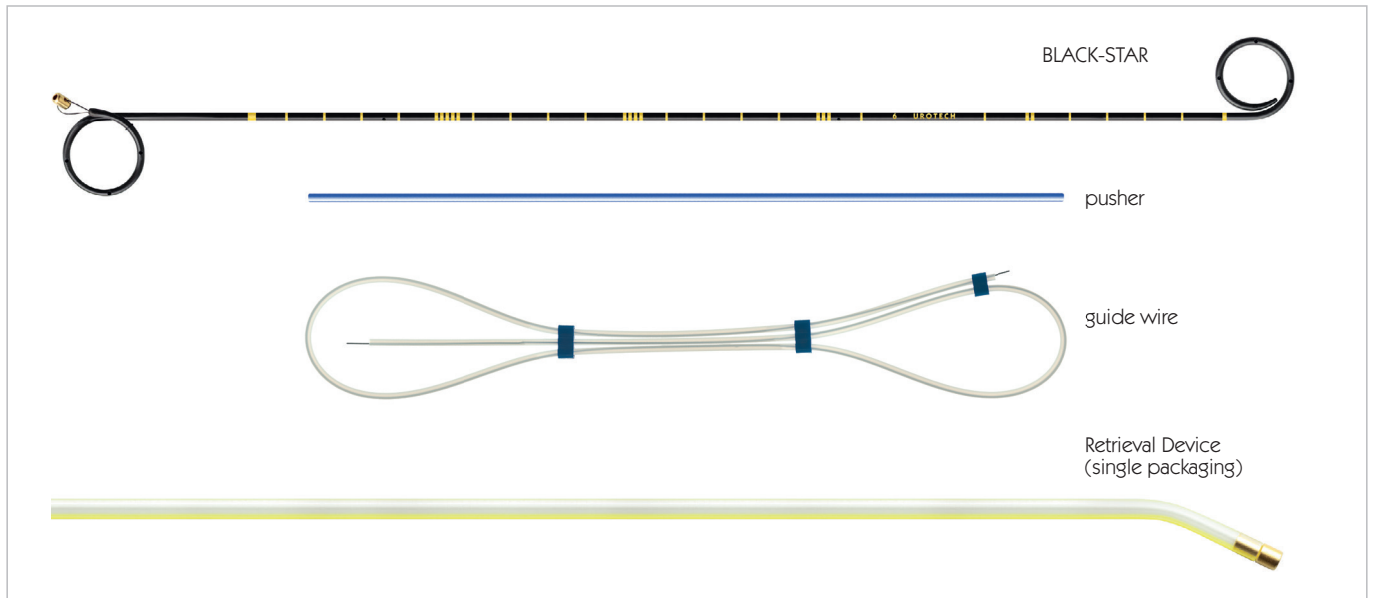

Ureteral Stent

- ◆ Polyurethane (PUR)
- ◆ Drainage openings in pigtails and shaft
- ◆ Open tip
- ◆ Markings for exact positioning
- ◆ Radiopaque
- ◆ Magnet at bladder side



Pusher

- ◆ Length: 40 cm

Guide Wire

- ◆ PTFE-coated

Retrieval Device with magnet

- ◆ Soft PUR
- ◆ Easy tip orientation via marking line
- ◆ Tiemann tip, 30°
- ◆ Single packaging

MAGNETIC BLACK-STAR Double-J Ureteral Stent-Set and Retrieval Device with magnet

Open tip								
Size (FR/CH)	Length (cm)	Size Magnet of the Stent (FR/CH)	Order Code without Guide Wire with Retrieval Device	Order Code with Guide Wire with Retrieval Device	Guide Wire Length (cm)	Guide Wire Diameter	Guide Wire Tip	Guide Wire Stiffness
4.8	10	07	MR-414810	MR-364810	150	0.028"	straight	standard
4.8	12	07	MR-414812	MR-364812	150	0.028"	straight	standard
4.8	15	07	MR-414815	MR-364815	150	0.028"	straight	standard
4.8	18	07	MR-414818	MR-364818	150	0.028"	straight	standard
4.8	20	07	MR-414820	MR-364820	150	0.028"	straight	standard
4.8	22	07	MR-414822	MR-364822	150	0.028"	straight	standard

Open tip without Retrieval Device								
Size (FR/CH)	Length (cm)	Size Magnet of the Stent (FR/CH)	Order Code without Guide Wire without Retrieval Device	Order Code with Guide Wire without Retrieval Device	Guide Wire Length (cm)	Guide Wire Diameter	Guide Wire Tip	Guide Wire Stiffness
4.8	10	07	MR-404810	MR-304810	150	0.028"	gerade	standard
4.8	12	07	MR-404812	MR-304812	150	0.028"	gerade	standard
4.8	15	07	MR-404815	MR-304815	150	0.028"	gerade	standard
4.8	18	07	MR-404818	MR-304818	150	0.028"	gerade	standard
4.8	20	07	MR-404820	MR-304820	150	0.028"	gerade	standard
4.8	22	07	MR-404822	MR-304822	150	0.028"	gerade	standard

Retrieval Device		
Size (FR/CH)	Length (cm)	Order Code suitable for FR/CH 4.8
09	40	R-Device-S

RENODRAIN-YELLOW Nephrostomy Puncture- and Exchange Set

Seldinger technique, Treated with PC, with pigtail

SET COMPONENTS

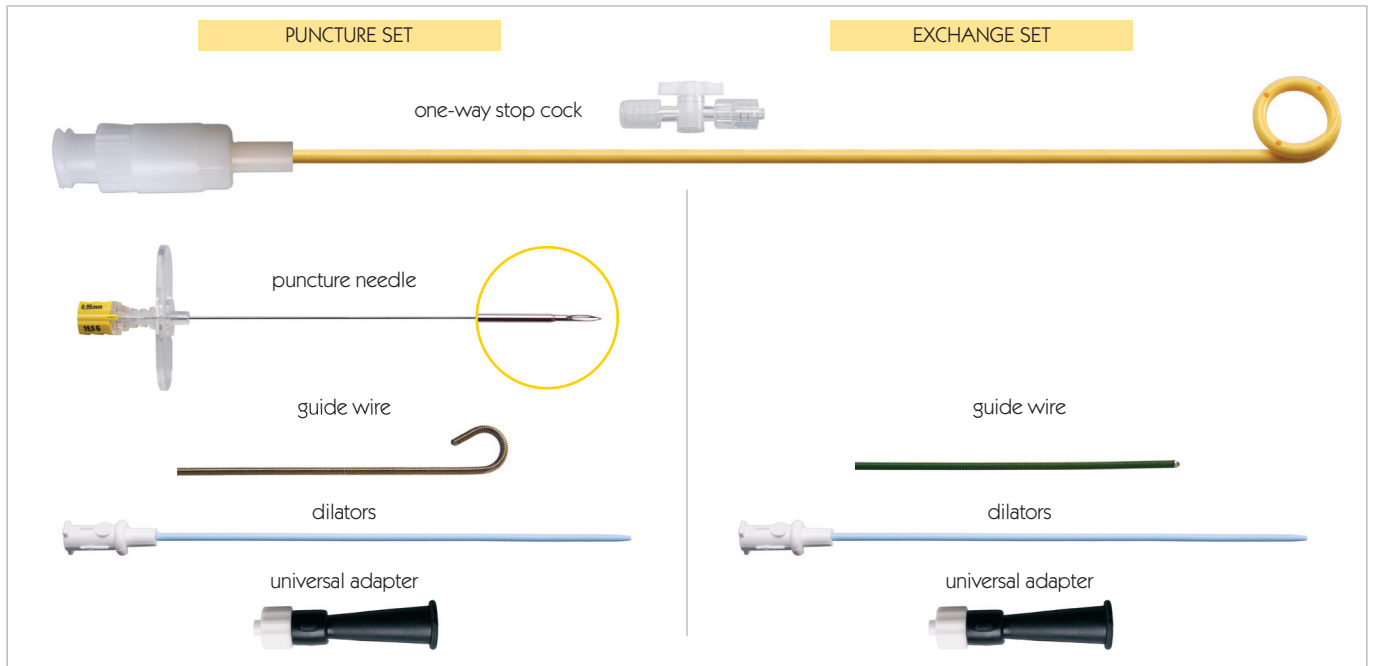

Nephrostomy Catheter

- ♦ Polyurethane (PUR)
- ♦ Treated with PC to minimise the risk of infection and encrustation, therefore extended indwelling time
- ♦ Drainage openings in pigtail
- ♦ Luer Lock Connector



Puncture Needle

- ♦ 2-part needle
- ♦ Medical stainless steel
- ♦ 20 G, length: 9 cm
- ♦ Ultrasonic visible

Guide Wire (Lunderquist)

- ♦ PTFE-coated

Universal Adapter

- ♦ For attachment of the urinary drainage bag

RENODRAIN-YELLOW Nephrostomy Puncture- and Exchange Set

Seldinger technique, Treated with PC, with pigtail

Single Catheter		
Size (FR/CH)	Length (cm)	Order Code Pigtail Catheter
06	24	RP-410640-K

Puncture Set							
Size (FR/CH)	Length (cm)	Order Code Puncture Set	Dilators (FR/CH)	Guide Wire Length (cm)	Guide Wire Diameter	Guide Wire Tip (r=1.5 mm)	Guide Wire Stiffness
06	24	RP-400640-K	05/06	70	0.025"	J-Tip	stiff

Exchange Set							
Size (FR/CH)	Length (cm)	Order Code Exchange Set	Dilators (FR/CH)	Guide Wire Length (cm)	Guide Wire Diameter	Guide Wire Tip	Guide Wire Stiffness
06	24	RP-400642-K	05/06	70	0.025"	straight	stiff

SUPRA-FIX Puncture- and Exchange Set

With pigtail, with funnel

SET COMPONENTS

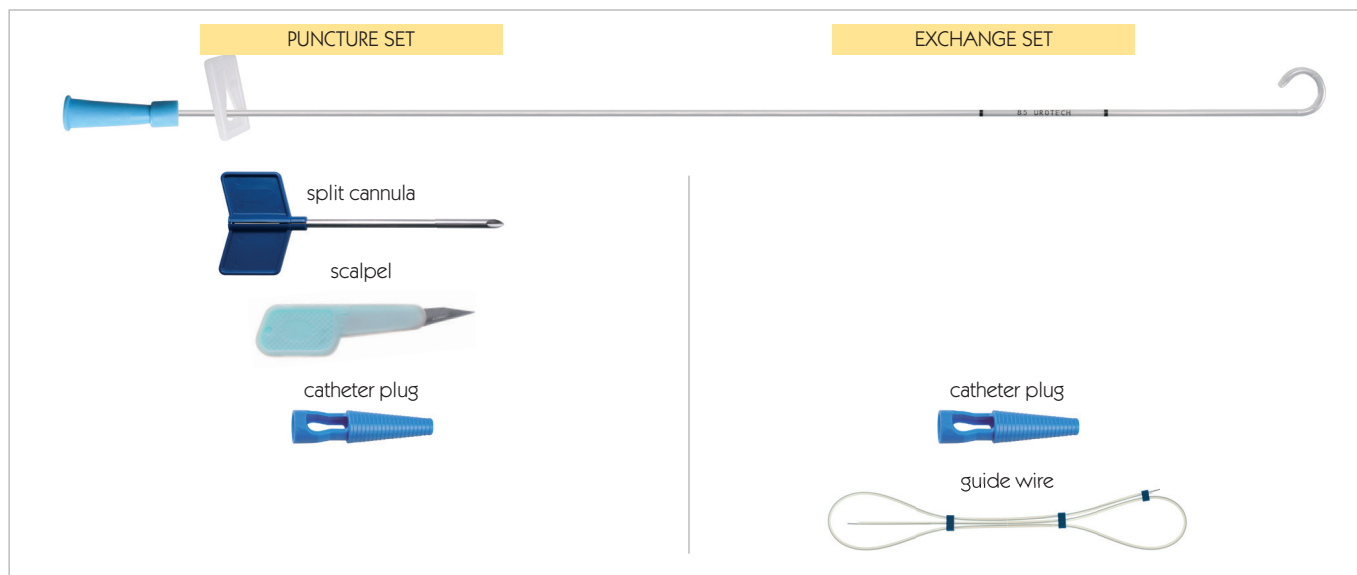

Pigtail Catheter

- ◆ Polyurethane (PUR)
- ◆ Flexible pigtail to avoid irritation
- ◆ Markings for exact positioning



Split Cannula

- ◆ Medical stainless steel
- ◆ Easy and safe splitting

Guide Wire (only in Exchange Set)

- ◆ PTFE-coated

Puncture Set				
Size (FR/CH)	Length (cm)	Order Code Puncture Set	Split Cannula Size Ø (mm)	Split Cannula Length (cm)
8.0	50	SU-081050	3.6	8
8.0	30	SU-081030	3.6	8

Exchange Set						
Size (FR/CH)	Length (cm)	Order Code Exchange Set	Guide Wire Length (cm)	Guide Wire Diameter	Guide Wire Tip	Guide Wire Stiffness
8.0	50	SU-081051	100	0.038"	straight	standard

2-WAY BALLOON CATHETER

100% silicone, Standard and Supersoft, with bonded balloon

DESCRIPTION

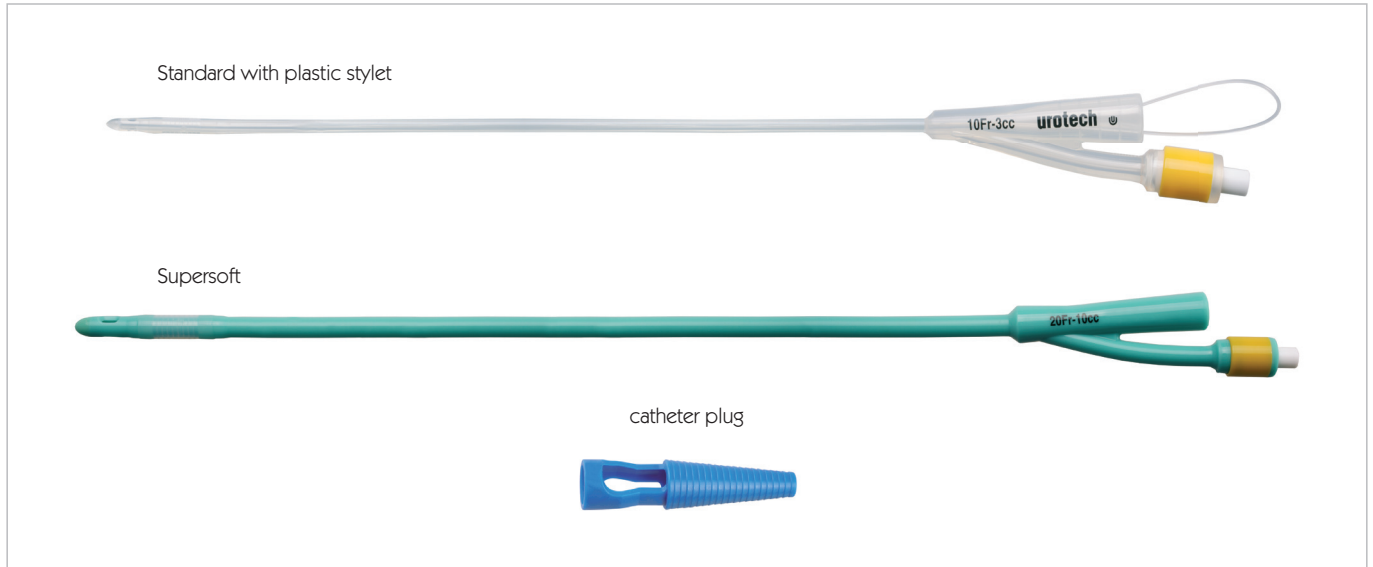

2-Way Balloon Catheter

💡 Silicone for optimal tissue compatibility

Standard			
Size (FR/CH)	Length (cm)	Balloon Capacity (ml)	Order Code
06	33	1.5	MA-220603
08	33	3.0	MA-220803
10	33	5.0	MA-221003

Supersoft			
Size (FR/CH)	Length (cm)	Balloon Capacity (ml)	Order Code
08	30	5.0	GR-600810
10	30	5.0	GR-601010

PYELOPLASTY CATHETER

For renal pelvis plastic

SET COMPONENTS

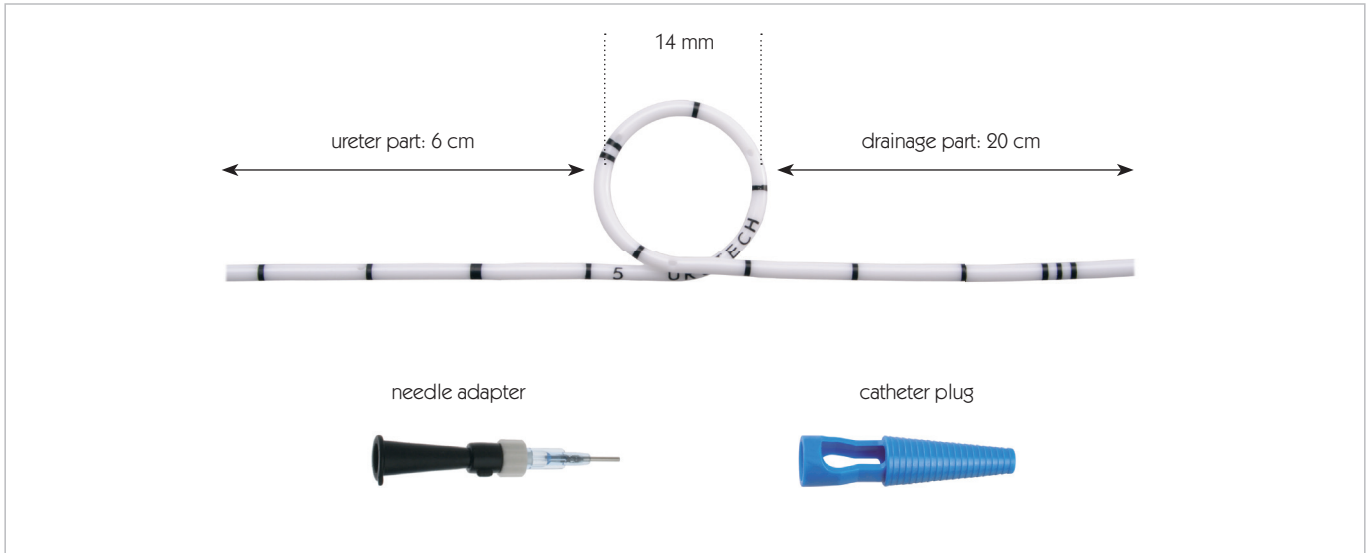

Pyeloplasty Catheter

- ◆ Polyurethane (PUR)
- ◆ Drainage openings in pigtail and in ureter part
- ◆ Markings for exact positioning
- ◆ Radiopaque

Needle Adapter

- ◆ For attachment of the urinary drainage bag

Size (FR/CH)	Length (cm)	Order Code	Max. Guide Wire Diameter
4.7	6 / 20	EK-620528	0.028"
06	6 / 20	EK-620628	0.035"

WWW.UROTECH.COM