

MASTERING MEDICAL CHALLENGES BY INNOVATION.

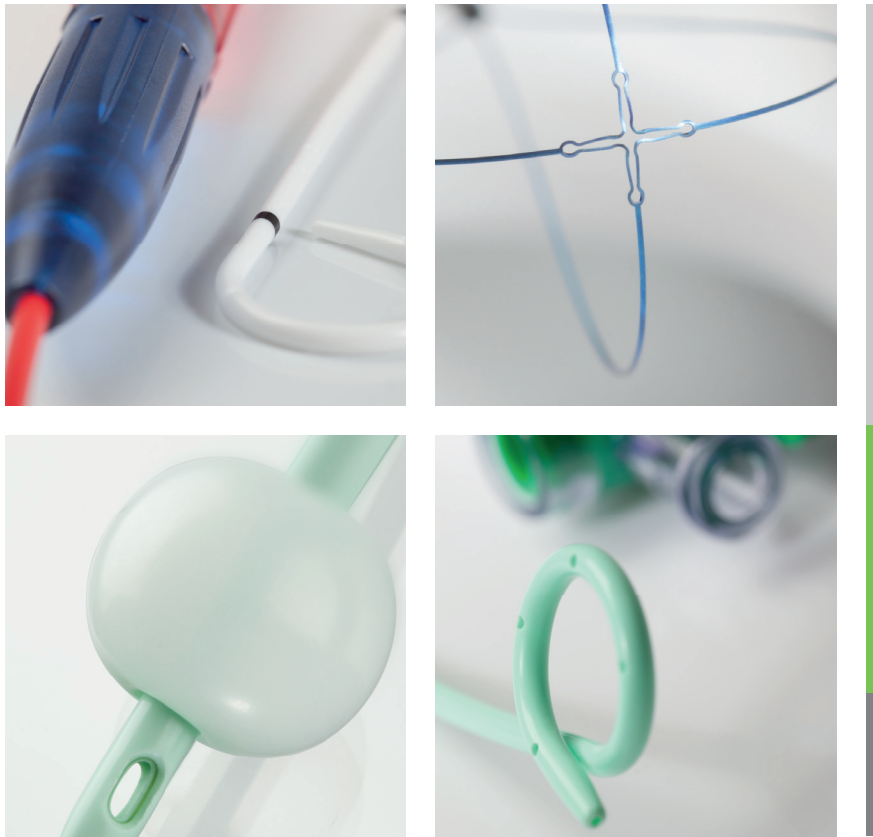

Products

CONTENTS



URETERAL STENTS
Chapter 1



NEPHROSTOMY
Chapter 2



STONE BASKETS
Chapter 3



URETERAL CATHETERS
Chapter 4



SURGICAL CATHETERS
Chapter 5



URODYNAMICS
Chapter 6

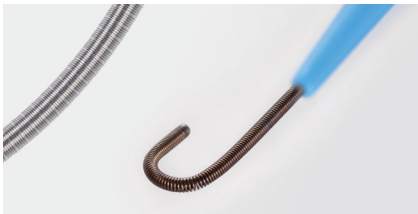

WIRES
Chapter 7



ACCESSORIES
Chapter 8



BIOPSY
Chapter 9



SUPRAPUBIC BLADDER DRAINAGE
Chapter 10



TRANSURETHRAL CATHETERS
Chapter 11



URINE DRAINAGE SYSTEMS
Chapter 12



PEDIATRICS
Chapter 13



SPECIAL PRODUCTS
Chapter 14

URETERAL STENTS



URETERAL STENTS

Ureteral Stents, standard	1.1
Ureteral Stents, soft	1.6
Tumor Stents	1.10
ESWL Ureteral Stent Set	1.14
VISIOSTAR Intraoperative	1.15
VISIOSTENT Stenosis	1.16
VISIO Anti-Reflux Stent	1.17
Intubation Stent	1.19
Pyeloplasty Catheters	1.20
VISIO WEB	1.21
Complete Sets	1.23

VISIOSTAR STANDARD Double-J Ureteral Stent Set

DESCRIPTION

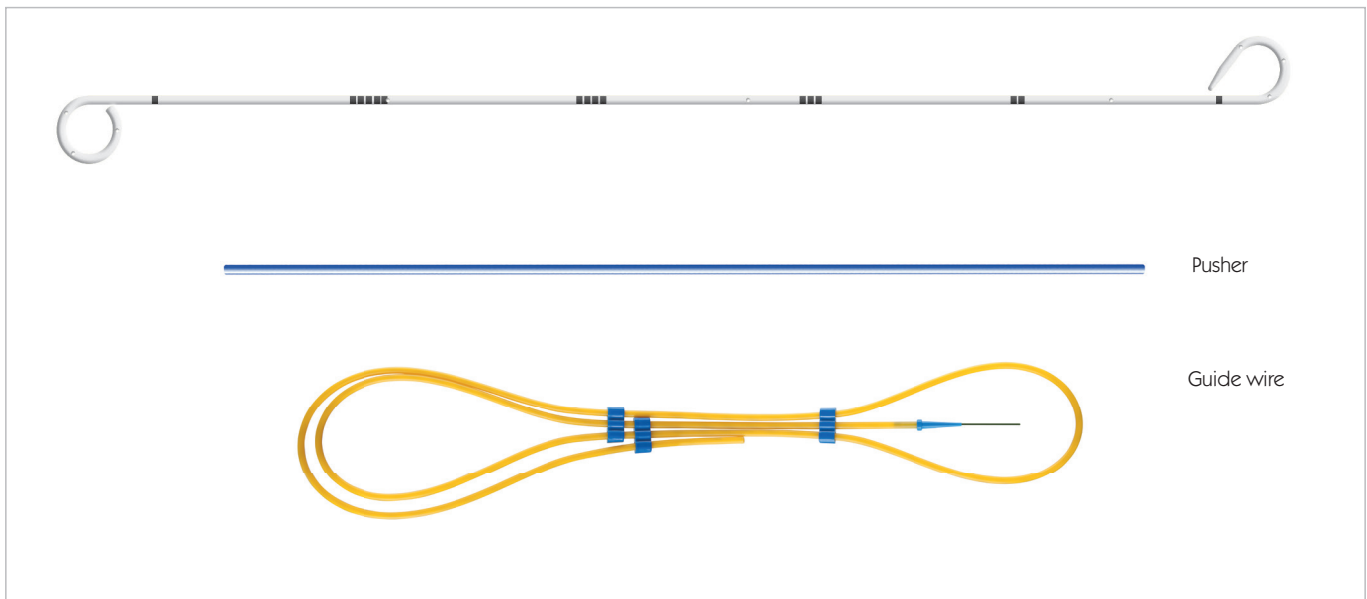

Ureteral Stent

- ◆ Polyurethane
- ◆ Drainage openings in pigtails and shaft
- ◆ Open or closed tip
- ◆ Markings for exact positioning
- ◆ Radiopaque

Pusher

- ◆ Length: 40 cm

Guide wire

- ◆ PTFE coating

Clip

- ◆ In sets with closed tip



URETERAL STENTS

VISIOSTAR STANDARD Double-J Ureteral Stent Set

Closed tip							
Order number with guide wire	Order number without guide wire	Size (CH/FR)	Length (cm)	Wire (inch)	Wire length (cm)	Wire tip	Wire stiffness
ST-194722	ST-1954722	4.7	22	0.028"	150	straight	standard
ST-194724	ST-1954724	4.7	24	0.028"	150	straight	standard
ST-194726	ST-1954726	4.7	26	0.028"	150	straight	standard
ST-194728	ST-1954728	4.7	28	0.028"	150	straight	standard
ST-194730	ST-1954730	4.7	30	0.028"	150	straight	standard
ST-190624	ST-195624	6	24	0.035"	150	straight	standard
ST-190626	ST-195626	6	26	0.035"	150	straight	standard
ST-190628	ST-195628	6	28	0.035"	150	straight	standard
ST-190630	ST-195630	6	30	0.035"	150	straight	standard
ST-190724	ST-195724	7	24	0.035"	150	straight	standard
ST-190726	ST-195726	7	26	0.035"	150	straight	standard
ST-190728	ST-195728	7	28	0.035"	150	straight	standard
ST-190730	ST-195730	7	30	0.035"	150	straight	standard
ST-190824	ST-195824	8	24	0.038"	150	straight	standard
ST-190826	ST-195826	8	26	0.038"	150	straight	standard
ST-190828	ST-195828	8	28	0.038"	150	straight	standard
ST-190830	ST-195830	8	30	0.038"	150	straight	standard
ST-190924	ST-195924	9	24	0.038"	150	straight	standard
ST-190926	ST-195926	9	26	0.038"	150	straight	standard
ST-190928	ST-195928	9	28	0.038"	150	straight	standard
ST-190930	ST-195930	9	30	0.038"	150	straight	standard
ST-191024	ST-1951024	10	24	0.045"	150	straight	standard
ST-191026	ST-1951026	10	26	0.045"	150	straight	standard
ST-191028	ST-1951028	10	28	0.045"	150	straight	standard
ST-191030	ST-191030	10	30	0.045"	150	straight	standard

Variants with sutures on the bladder end are available on request.

URETERAL STENTS

Open tip							
Order number with guide wire	Order number without guide wire	Size (CH/FR)	Length (cm)	Wire (inch)	Wire length (cm)	Wire tip	Wire stiffness
ST-184722	ST-1974722	4.7	22	0.028"	150	straight	standard
ST-184724	ST-1974724	4.7	24	0.028"	150	straight	standard
ST-184726	ST-1974726	4.7	26	0.028"	150	straight	standard
ST-184728	ST-1974728	4.7	28	0.028"	150	straight	standard
ST-184730	ST-1974730	4.7	30	0.028"	150	straight	standard
ST-180624	ST-197624	6	24	0.035"	150	straight	standard
ST-180626	ST-197626	6	26	0.035"	150	straight	standard
ST-180628	ST-197628	6	28	0.035"	150	straight	standard
ST-180630	ST-197630	6	30	0.035"	150	straight	standard
ST-180724	ST-197724	7	24	0.035"	150	straight	standard
ST-180726	ST-197726	7	26	0.035"	150	straight	standard
ST-180728	ST-197728	7	28	0.035"	150	straight	standard
ST-180730	ST-197730	7	30	0.035"	150	straight	standard
ST-180824	ST-197824	8	24	0.038"	150	straight	standard
ST-180826	ST-197826	8	26	0.038"	150	straight	standard
ST-180828	ST-197828	8	28	0.038"	150	straight	standard
ST-180830	ST-197830	8	30	0.038"	150	straight	standard
ST-180924	ST-197924	9	24	0.038"	150	straight	standard
ST-180926	ST-197926	9	26	0.038"	150	straight	standard
ST-180928	ST-197928	9	28	0.038"	150	straight	standard
ST-180930	ST-197930	9	30	0.038"	150	straight	standard
ST-181024	ST-1971024	10	24	0.045"	150	straight	standard
ST-181026	ST-1971026	10	26	0.045"	150	straight	standard
ST-181028	ST-1971028	10	28	0.045"	150	straight	standard
ST-181030	ST-1971030	10	30	0.045"	150	straight	standard

Variants with sutures on the bladder end are available on request.

VISIOSTAR STANDARD Double-J Ureteral Stent Set

Flexible length

DESCRIPTION

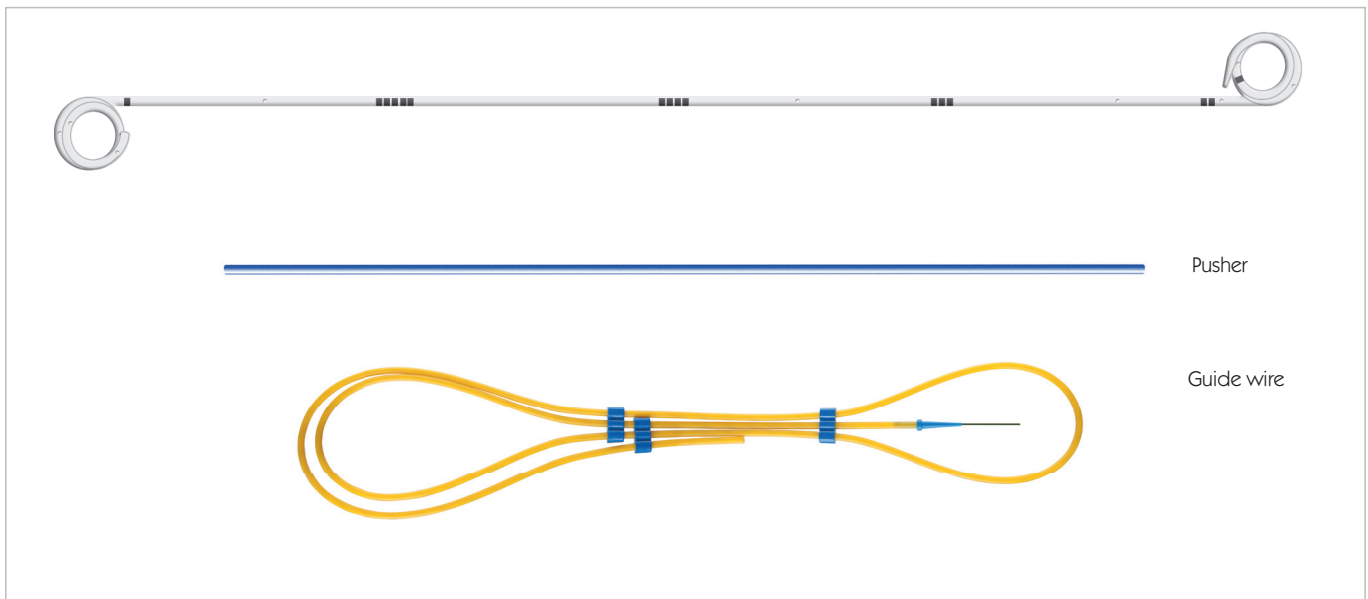

Ureteral Stent

- ◆ Polyurethane
- ◆ Multiple coils on both sides for shaft length flexibility from 24 to 32 cm
- ◆ Drainage openings in pigtails and shaft
- ◆ Open or closed tip
- ◆ Markings for exact positioning
- ◆ Radiopaque

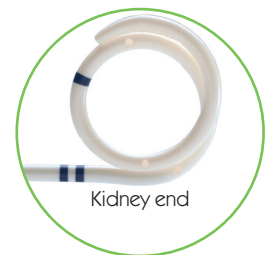
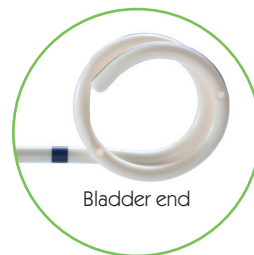

Pusher

- ◆ Length: 40 cm

Guide wire

- ◆ PTFE coating

Clip

- ◆ In sets with closed tip



URETERAL STENTS

Open tip							
Order number with guide wire	Order number without guide wire	Size (CH/FR)	Length (cm)	Wire (inch)	Wire length (cm)	Wire tip	Wire stiffness
ST-394724-32	ST-3974724-32	4.7	24-32	0.028"	150	straight	standard
ST-390624-32	ST-397624-32	6	24-32	0.035"	150	straight	standard
ST-390724-32	ST-397724-32	7	24-32	0.035"	150	straight	standard
ST-390824-32	ST-397824-32	8	24-32	0.038"	150	straight	standard

Closed tip							
Order number with guide wire		Size (CH/FR)	Length (cm)	Wire (inch)	Wire length (cm)	Wire tip	Wire stiffness
ST-384724-32		4.7	24-32	0.028"	150	straight	standard
ST-380624-32		6	24-32	0.035"	150	straight	standard
ST-380724-32		7	24-32	0.035"	150	straight	standard
ST-380824-32		8	24-32	0.038"	150	straight	standard

VISIOSTAR STANDARD Double-J Ureteral Stent Set Steerable

DESCRIPTION

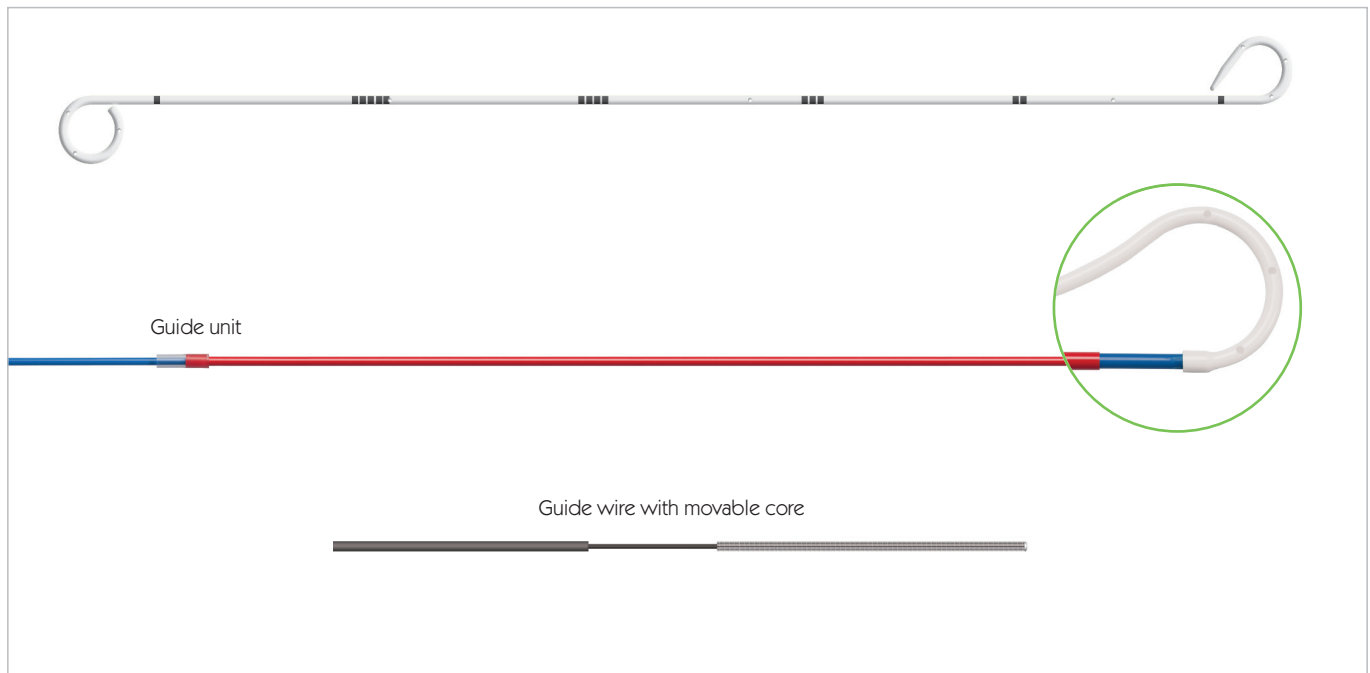

Ureteral Stent

- ◆ Polyurethane
- ◆ Drainage openings in pigtails and shaft
- ◆ Open or closed tip
- ◆ Markings for exact positioning
- ◆ Radiopaque

Guide unit

- ◆ Pusher
- ◆ Disconnector
- ◆ Length: 53 cm

Guide wire

- ◆ PTFE coating

Clip

- ◆ In sets with closed tip



URETERAL STENTS

Open tip							
Order number with guide wire	Order number without guide wire	Size (CH/FR)	Length (cm)	Wire (inch)	Wire length (cm)	Wire tip	Wire stiffness
US-110524	US-120524	4.7	24	0.028"	150	straight	standard
US-110526	US-120526	4.7	26	0.028"	150	straight	standard
US-110528	US-120528	4.7	28	0.028"	150	straight	standard
US-110530	US-120530	4.7	30	0.028"	150	straight	standard
US-110624	US-120624	6	24	0.035"	150	straight	standard/movable core
US-110626	US-120626	6	26	0.035"	150	straight	standard/movable core
US-110628	US-120628	6	28	0.035"	150	straight	standard/movable core
US-110630	US-120630	6	30	0.035"	150	straight	standard/movable core
US-110724	US-120724	7	24	0.035"	150	straight	standard/movable core
US-110726	US-120726	7	26	0.035"	150	straight	standard/movable core
US-110728	US-120728	7	28	0.035"	150	straight	standard/movable core
US-110730	US-120730	7	30	0.035"	150	straight	standard/movable core
US-110824	US-120824	8	24	0.038"	150	straight	standard
US-110826	US-120826	8	26	0.038"	150	straight	standard
US-110828	US-120828	8	28	0.038"	150	straight	standard
US-110830	US-120830	8	30	0.038"	150	straight	standard
US-110924	US-120924	9	24	0.038"	150	straight	standard
US-110926	US-120926	9	26	0.038"	150	straight	standard
US-110928	US-120928	9	28	0.038"	150	straight	standard
US-110930	US-120930	9	30	0.038"	150	straight	standard

URETERAL STENTS

VISIOSTAR STANDARD Double-J Ureteral Stent Set Steerable

Closed tip							
Order number with guide wire		Size (CH/FR)	Length (cm)	Wire (inch)	Wire length (cm)	Wire tip	Wire stiffness
US-100524		4.7	24	0.028"	150	straight	standard
US-100526		4.7	26	0.028"	150	straight	standard
US-100528		4.7	28	0.028"	150	straight	standard
US-100530		4.7	30	0.028"	150	straight	standard
US-100624		6	24	0.035"	150	J-tip	standard/movable core
US-100626		6	26	0.035"	150	J-tip	standard/movable core
US-100628		6	28	0.035"	150	J-tip	standard/movable core
US-100630		6	30	0.035"	150	J-tip	standard/movable core
US-100724		7	24	0.035"	150	J-tip	standard/movable core
US-100726		7	26	0.035"	150	J-tip	standard/movable core
US-100728		7	28	0.035"	150	J-tip	standard/movable core
US-100730		7	30	0.035"	150	J-tip	standard/movable core
US-100824		8	24	0.038"	150	straight	standard
US-100826		8	26	0.038"	150	straight	standard
US-100828		8	28	0.038"	150	straight	standard
US-100830		8	30	0.038"	150	straight	standard
US-100924		9	24	0.038"	150	straight	standard
US-100926		9	26	0.038"	150	straight	standard
US-100928		9	28	0.038"	150	straight	standard
US-100930		9	30	0.038"	150	straight	standard

VISIOMATIC® Double-J Ureteral Stent Set Steerable with VISIOMATIC® Discharge System

DESCRIPTION

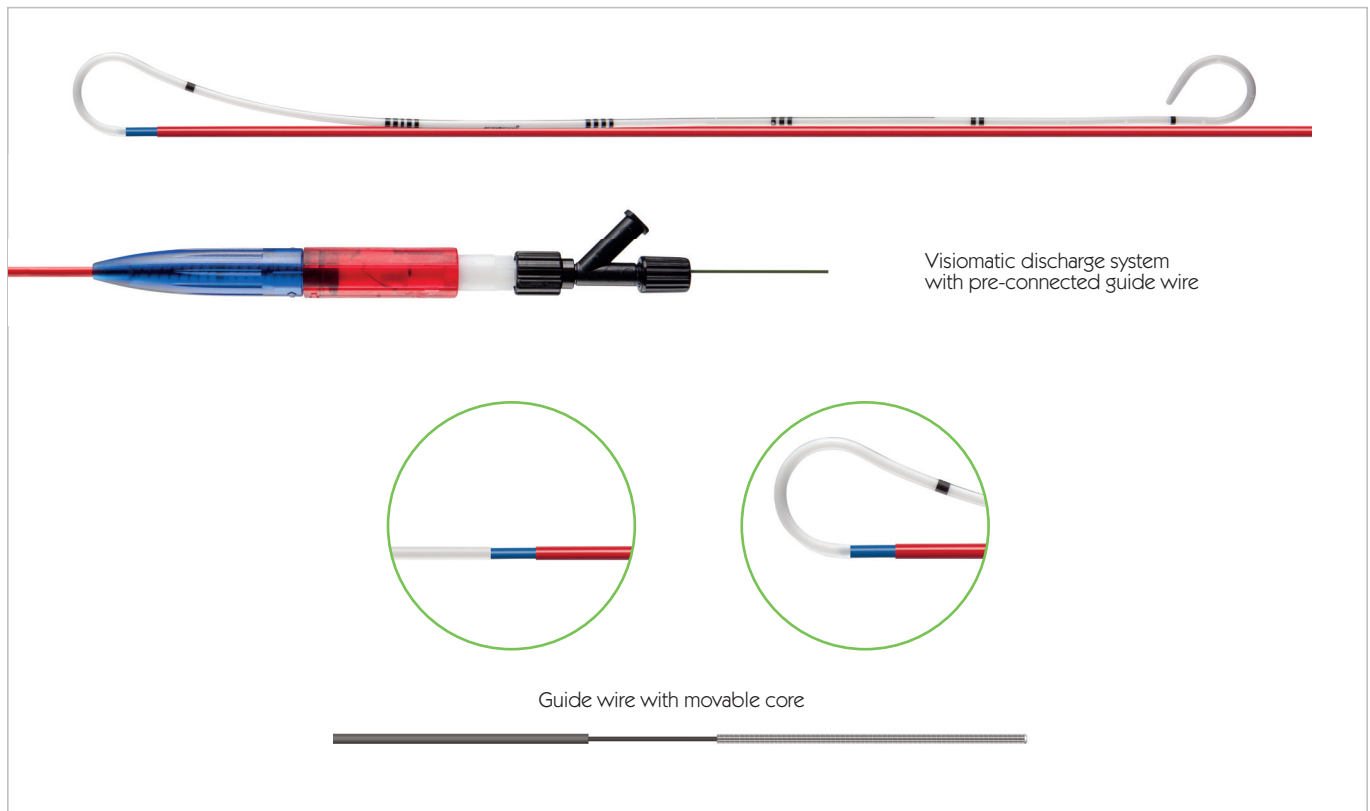

Ureteral Stent

- ◆ Polyurethane
- ◆ Drainage openings in pigtails and shaft
- ◆ Open or closed tip
- ◆ Markings for exact positioning
- ◆ Radiopaque

Visiomatic discharge system

- ◆ Pusher
- ◆ Disconnector
- ◆ Y-adaptor with crimp coupling for securing the guide wire
- ◆ Length: 51 cm

Guide wire

- ◆ PTFE coating

URETERAL STENTS

VISIOMATIC® Double-J Ureteral Stent Set Steerable with VISIOMATIC® Discharge System

Open tip							
Order number with guide wire	Order number without guide wire	Size (CH/FR)	Length (cm)	Wire (inch)	Wire length (cm)	Wire tip	Wire stiffness
US-110524-V	US-120524-V	4.7	24	0.028"	150	straight	standard
US-110526-V	US-120526-V	4.7	26	0.028"	150	straight	standard
US-110528-V	US-120528-V	4.7	28	0.028"	150	straight	standard
US-110530-V	US-120530-V	4.7	30	0.028"	150	straight	standard
US-110624-V	US-120624-V	6	24	0.035"	150	straight	standard/movable core
US-110626-V	US-120626-V	6	26	0.035"	150	straight	standard/movable core
US-110628-V	US-120628-V	6	28	0.035"	150	straight	standard/movable core
US-110630-V	US-120630-V	6	30	0.035"	150	straight	standard/movable core
US-110724-V	US-120724-V	7	24	0.035"	150	straight	standard/movable core
US-110726-V	US-120726-V	7	26	0.035"	150	straight	standard/movable core
US-110728-V	US-120728-V	7	28	0.035"	150	straight	standard/movable core
US-110730-V	US-120730-V	7	30	0.035"	150	straight	standard/movable core
US-110824-V	US-120824-V	8	24	0.038"	150	straight	standard
US-110826-V	US-120826-V	8	26	0.038"	150	straight	standard
US-110828-V	US-120828-V	8	28	0.038"	150	straight	standard
US-110830-V	US-120830-V	8	30	0.038"	150	straight	standard
US-110924-V	US-120924-V	9	24	0.038"	150	straight	standard
US-110926-V	US-120926-V	9	26	0.038"	150	straight	standard
US-110928-V	US-120928-V	9	28	0.038"	150	straight	standard
US-110930-V	US-120930-V	9	30	0.038"	150	straight	standard

URETERAL STENTS

Closed tip							
Order number with guide wire		Size (CH/FR)	Length (cm)	Wire (inch)	Wire length (cm)	Wire tip	Wire stiffness
US-100524-V		4.7	24	0.028"	150	straight	standard
US-100526-V		4.7	26	0.028"	150	straight	standard
US-100528-V		4.7	28	0.028"	150	straight	standard
US-100530-V		4.7	30	0.028"	150	straight	standard
US-100624-V		6	24	0.035"	150	J-tip	standard/movable core
US-100626-V		6	26	0.035"	150	J-tip	standard/movable core
US-100628-V		6	28	0.035"	150	J-tip	standard/movable core
US-100630-V		6	30	0.035"	150	J-tip	standard/movable core
US-100724-V		7	24	0.035"	150	J-tip	standard/movable core
US-100726-V		7	26	0.035"	150	J-tip	standard/movable core
US-100728-V		7	28	0.035"	150	J-tip	standard/movable core
US-100730-V		7	30	0.035"	150	J-tip	standard/movable core
US-100824-V		8	24	0.038"	150	straight	standard
US-100826-V		8	26	0.038"	150	straight	standard
US-100828-V		8	28	0.038"	150	straight	standard
US-100830-V		8	30	0.038"	150	straight	standard
US-100924-V		9	24	0.038"	150	straight	standard
US-100926-V		9	26	0.038"	150	straight	standard
US-100928-V		9	28	0.038"	150	straight	standard
US-100930-V		9	30	0.038"	150	straight	standard

MONOSTAR STANDARD Mono-J Ureteral Stent Set

DESCRIPTION

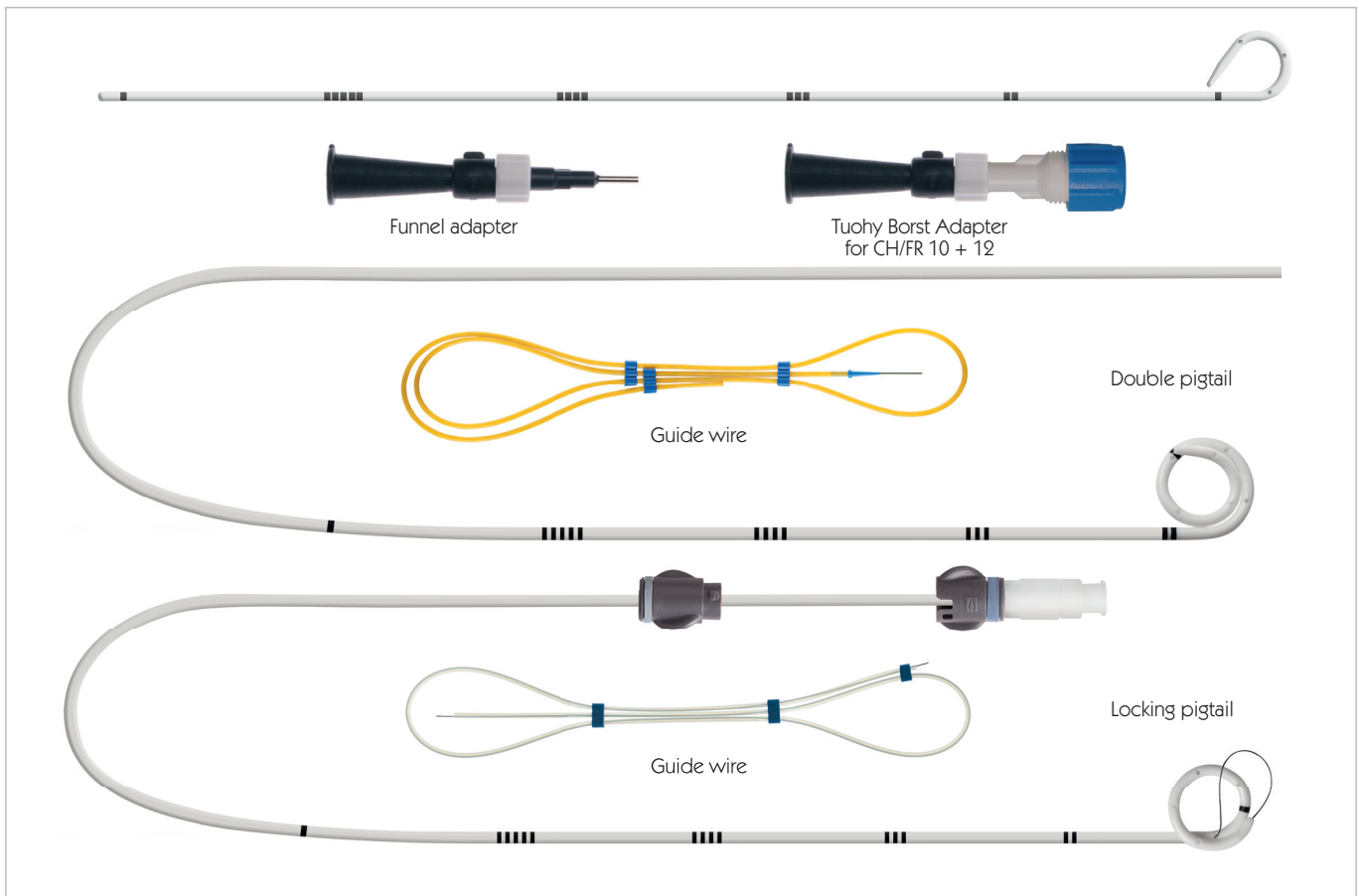

Ureteral Stent

- ◆ Polyurethane
- ◆ Drainage openings only available for pigtail
- ◆ Open or closed tip
- ◆ Markings for exact positioning
- ◆ Radiopaque

Guide wire

- ◆ PTFE coating

Funnel adapter

- ◆ For CH/FR 04 to 09

Clip

- ◆ In sets with closed tip



URETERAL STENTS

Mono-J with Double Pigtail							
Order number with guide wire		Size (CH/FR)	Length (cm)	Wire (inch)	Wire length (cm)	Wire tip	Wire stiffness
ST-250700-DP		7	70	0.035"	150	straight	standard
ST-250800-DP		8	70	0.038"	150	straight	standard
ST-250900-DP		9	70	0.038"	150	straight	standard

Open tip							
Order number with guide wire	Order number without guide wire	Size (CH/FR)	Length (cm)	Wire (inch)	Wire length (cm)	Wire tip	Wire stiffness
ST-250400	ST-257400	4	70	0.025"	150	straight	standard
ST-250500	ST-257500	5	70	0.028"	150	straight	standard
ST-250600	ST-257600	6	70	0.035"	150	straight	standard
ST-250700	ST-257700	7	70	0.035"	150	straight	standard
ST-250800	ST-257800	8	70	0.038"	150	straight	standard
ST-250900	ST-257900	9	70	0.038"	150	straight	standard
ST-251000	ST-257000	10	70	0.045"	150	straight	standard
ST-251200	ST-257200	12	70	0.045"	150	straight	standard

Closed tip							
Order number with guide wire		Size (CH/FR)	Length (cm)	Wire (inch)	Wire length (cm)	Wire tip	Wire stiffness
ST-240470		4	70	0.025"	150	straight	standard
ST-240570		5	70	0.028"	150	straight	standard
ST-240670		6	70	0.035"	150	straight	standard
ST-240770		7	70	0.035"	150	straight	standard
ST-240870		8	70	0.038"	150	straight	standard
ST-240970		9	70	0.038"	150	straight	standard
ST-241070		10	70	0.045"	150	straight	standard
ST-241270		12	70	0.045"	150	straight	standard

White Star Mono-J with Magnusson Locking Pigtail							
Order number with guide wire		Size (CH/FR)	Length (cm)	Wire (inch)	Wire length (cm)	Wire tip	Wire stiffness
EN-350841-FI		8	40	0.035"	150	straight	standard
EN-350851-FI		8	50	0.035"	150	straight	standard
EN-350861-FI		8	60	0.035"	150	straight	standard

Commercial products distributed by UROVISION.

VISIOSTAR SOFT Double-J Ureteral Stent Set

Soft material

DESCRIPTION

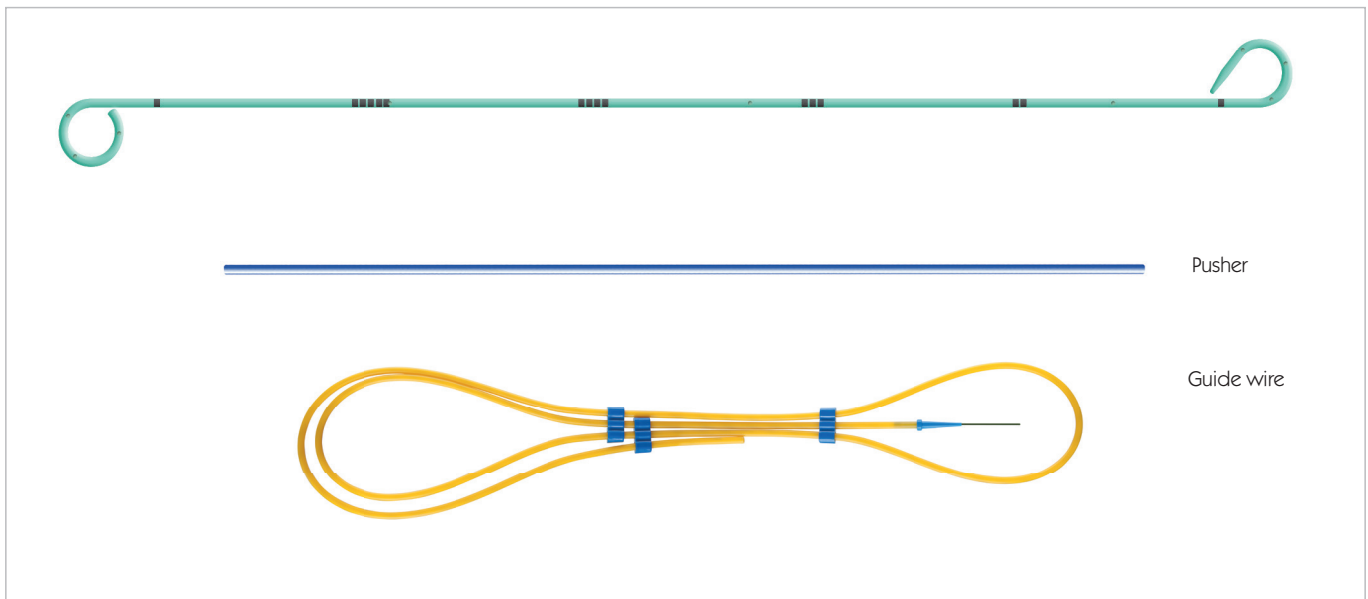

Ureteral Stent

- ◆ Polyurethane
- ◆ Especially soft material to ensure a high level of patient comfort
- ◆ Drainage openings in pigtails and shaft
- ◆ Open or closed tip
- ◆ Markings for exact positioning
- ◆ Radiopaque

Pusher

- ◆ Length: 40 cm

Guide wire

- ◆ PTFE coating

Clip

- ◆ In sets with closed tip



URETERAL STENTS

Open tip							
Order number with guide wire	Order number without guide wire	Size (CH/FR)	Length (cm)	Wire (inch)	Wire length (cm)	Wire tip	Wire stiffness
ST-214722	ST-2174722	4.7	22	0.028"	150	straight	standard
ST-214724	ST-2174724	4.7	24	0.028"	150	straight	standard
ST-214726	ST-2174726	4.7	26	0.028"	150	straight	standard
ST-214728	ST-2174728	4.7	28	0.028"	150	straight	standard
ST-214730	ST-2174730	4.7	30	0.028"	150	straight	standard
ST-210624	ST-217624	6	24	0.035"	150	straight	standard
ST-210626	ST-217626	6	26	0.035"	150	straight	standard
ST-210628	ST-217628	6	28	0.035"	150	straight	standard
ST-210630	ST-217630	6	30	0.035"	150	straight	standard
ST-210724	ST-217724	7	24	0.035"	150	straight	standard
ST-210726	ST-217726	7	26	0.035"	150	straight	standard
ST-210728	ST-217728	7	28	0.035"	150	straight	standard
ST-210730	ST-217730	7	30	0.035"	150	straight	standard
ST-210824	ST-217824	8	24	0.038"	150	straight	standard
ST-210826	ST-217826	8	26	0.038"	150	straight	standard
ST-210828	ST-217828	8	28	0.038"	150	straight	standard
ST-210830	ST-217830	8	30	0.038"	150	straight	standard

Closed tip							
Order number with guide wire	Order number without guide wire	Size (CH/FR)	Length (cm)	Wire (inch)	Wire length (cm)	Wire tip	Wire stiffness
ST-204722	ST-2054722	4.7	22	0.028"	150	straight	standard
ST-204724	ST-2054724	4.7	24	0.028"	150	straight	standard
ST-204726	ST-2054726	4.7	26	0.028"	150	straight	standard
ST-204728	ST-2054728	4.7	28	0.028"	150	straight	standard
ST-204730	ST-2054730	4.7	30	0.028"	150	straight	standard
ST-200624	ST-205624	6	24	0.035"	150	straight	standard
ST-200626	ST-205626	6	26	0.035"	150	straight	standard
ST-200628	ST-205628	6	28	0.035"	150	straight	standard
ST-200630	ST-205630	6	30	0.035"	150	straight	standard
ST-200724	ST-205724	7	24	0.035"	150	straight	standard
ST-200726	ST-205726	7	26	0.035"	150	straight	standard
ST-200728	ST-205728	7	28	0.035"	150	straight	standard
ST-200730	ST-205730	7	30	0.035"	150	straight	standard
ST-200824	ST-205824	8	24	0.038"	150	straight	standard
ST-200826	ST-205826	8	26	0.038"	150	straight	standard
ST-200828	ST-205828	8	28	0.038"	150	straight	standard
ST-200830	ST-205830	8	30	0.038"	150	straight	standard

Variants with sutures on the bladder end are available on request.

VISIOSTAR SOFT Double-J Ureteral Stent Set

Steerable, soft material

DESCRIPTION

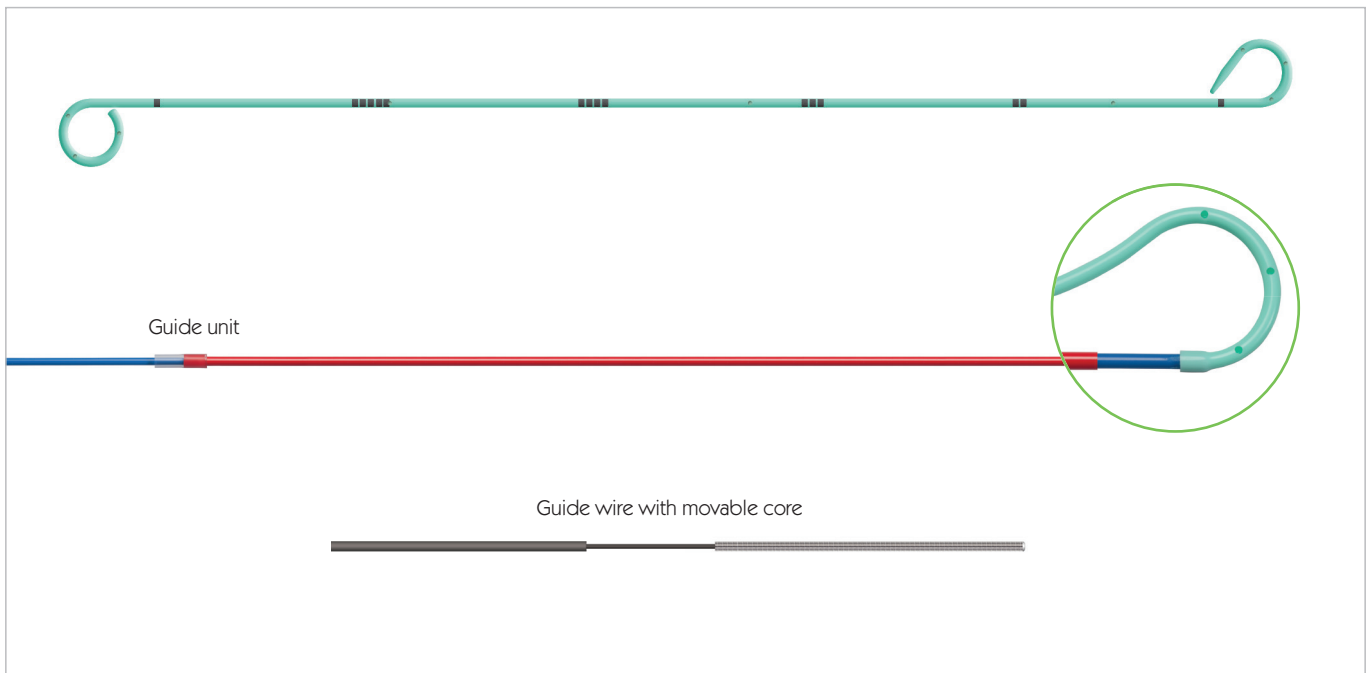

Ureteral Stent

- ◆ Polyurethane
- ◆ Especially soft material to ensure a high level of wearing comfort
- ◆ Drainage openings in pigtails and shaft
- ◆ Open or closed tip
- ◆ Markings for exact positioning
- ◆ Radiopaque

Guide unit

- ◆ Pusher
- ◆ Disconnecter
- ◆ Length: 53 cm

Guide wire

- ◆ PTFE coating

Clip

- ◆ In sets with closed tip



SOFT URETERAL STENTS

Open tip							
Order number with guide wire	Order number without guide wire	Size (CH/FR)	Length (cm)	Wire (inch)	Wire length (cm)	Wire tip	Wire stiffness
US-140524	US-150524	4.7	24	0.028"	150	straight	standard
US-140526	US-150526	4.7	26	0.028"	150	straight	standard
US-140528	US-150528	4.7	28	0.028"	150	straight	standard
US-140530	US-150530	4.7	30	0.028"	150	straight	standard
US-140624	US-150624	6	24	0.035"	150	straight	standard/movable core
US-140626	US-150626	6	26	0.035"	150	straight	standard/movable core
US-140628	US-150628	6	28	0.035"	150	straight	standard/movable core
US-140630	US-150630	6	30	0.035"	150	straight	standard/movable core
US-140724	US-150724	7	24	0.035"	150	straight	standard/movable core
US-140726	US-150726	7	26	0.035"	150	straight	standard/movable core
US-140728	US-150728	7	28	0.035"	150	straight	standard/movable core
US-140730	US-150730	7	30	0.035"	150	straight	standard/movable core
US-140824	US-150824	8	24	0.038"	150	straight	standard
US-140826	US-150826	8	26	0.038"	150	straight	standard
US-140828	US-150828	8	28	0.038"	150	straight	standard
US-140830	US-150830	8	30	0.038"	150	straight	standard

Closed tip							
Order number with guide wire		Size (CH/FR)	Length (cm)	Wire (inch)	Wire length (cm)	Wire tip	Wire stiffness
US-130524		4.7	24	0.028"	150	straight	standard
US-130526		4.7	26	0.028"	150	straight	standard
US-130528		4.7	28	0.028"	150	straight	standard
US-130530		4.7	30	0.028"	150	straight	standard
US-130624		6	24	0.035"	150	J-tip	standard/movable core
US-130626		6	26	0.035"	150	J-tip	standard/movable core
US-130628		6	28	0.035"	150	J-tip	standard/movable core
US-130630		6	30	0.035"	150	J-tip	standard/movable core
US-130724		7	24	0.035"	150	J-tip	standard/movable core
US-130726		7	26	0.035"	150	J-tip	standard/movable core
US-130728		7	28	0.035"	150	J-tip	standard/movable core
US-130730		7	30	0.035"	150	J-tip	standard/movable core
US-130824		8	24	0.038"	150	straight	standard
US-130826		8	26	0.038"	150	straight	standard
US-130828		8	28	0.038"	150	straight	standard
US-130830		8	30	0.038"	150	straight	standard

VISIOMATIC® Double-J Ureteral Stent Set

Soft material, steerable with VISIOMATIC® discharge system

DESCRIPTION

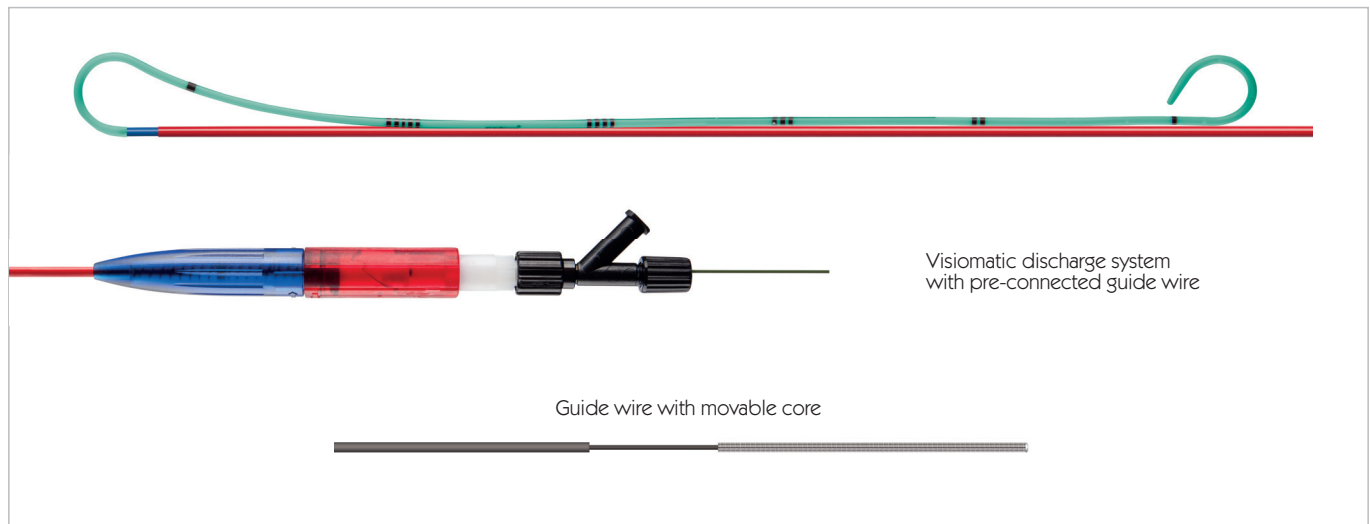

Ureteral Stent

- ◆ Polyurethane
- ◆ Especially soft material to ensure a high level of patient comfort
- ◆ Drainage openings in pigtails and shaft
- ◆ Open or closed tip
- ◆ Markings for exact positioning
- ◆ Radiopaque

Visiomatic discharge system

- ◆ Pusher
- ◆ Disconnector
- ◆ Y-adaptor with crimp coupling for securing the guide wire
- ◆ Length: 51 cm

Guide wire

- ◆ PTFE coating

SOFT URETERAL STENTS

Open tip							
Order number with guide wire	Order number without guide wire	Size (CH/FR)	Length (cm)	Wire (inch)	Wire length (cm)	Wire tip	Wire stiffness
US-140524-V	US-150524-V	4.7	24	0.028"	150	straight	standard
US-140526-V	US-150526-V	4.7	26	0.028"	150	straight	standard
US-140528-V	US-150528-V	4.7	28	0.028"	150	straight	standard
US-140530-V	US-150530-V	4.7	30	0.028"	150	straight	standard
US-140624-V	US-150624-V	6	24	0.035"	150	straight	standard/movable core
US-140626-V	US-150626-V	6	26	0.035"	150	straight	standard/movable core
US-140628-V	US-150628-V	6	28	0.035"	150	straight	standard/movable core
US-140630-V	US-150630-V	6	30	0.035"	150	straight	standard/movable core
US-140724-V	US-150724-V	7	24	0.035"	150	straight	standard/movable core
US-140726-V	US-150726-V	7	26	0.035"	150	straight	standard/movable core
US-140728-V	US-150728-V	7	28	0.035"	150	straight	standard/movable core
US-140730-V	US-150730-V	7	30	0.035"	150	straight	standard/movable core
US-140824-V	US-150824-V	8	24	0.038"	150	straight	standard
US-140826-V	US-150826-V	8	26	0.038"	150	straight	standard
US-140828-V	US-150828-V	8	28	0.038"	150	straight	standard
US-140830-V	US-150830-V	8	30	0.038"	150	straight	standard

Closed tip							
Order number with guide wire		Size (CH/FR)	Length (cm)	Wire (inch)	Wire length (cm)	Wire tip	Wire stiffness
US-130524-V		4.7	24	0.028"	150	straight	standard
US-130526-V		4.7	26	0.028"	150	straight	standard
US-130528-V		4.7	28	0.028"	150	straight	standard
US-130530-V		4.7	30	0.028"	150	straight	standard
US-130624-V		6	24	0.035"	150	J-tip	standard/movable core
US-130626-V		6	26	0.035"	150	J-tip	standard/movable core
US-130628-V		6	28	0.035"	150	J-tip	standard/movable core
US-130630-V		6	30	0.035"	150	J-tip	standard/movable core
US-130724-V		7	24	0.035"	150	J-tip	standard/movable core
US-130726-V		7	26	0.035"	150	J-tip	standard/movable core
US-130728-V		7	28	0.035"	150	J-tip	standard/movable core
US-130730-V		7	30	0.035"	150	J-tip	standard/movable core
US-130824-V		8	24	0.038"	150	straight	standard
US-130826-V		8	26	0.038"	150	straight	standard
US-130828-V		8	28	0.038"	150	straight	standard
US-130830-V		8	30	0.038"	150	straight	standard

MONOSTAR SOFT Mono-J Ureteral Stent Set

Soft material

DESCRIPTION

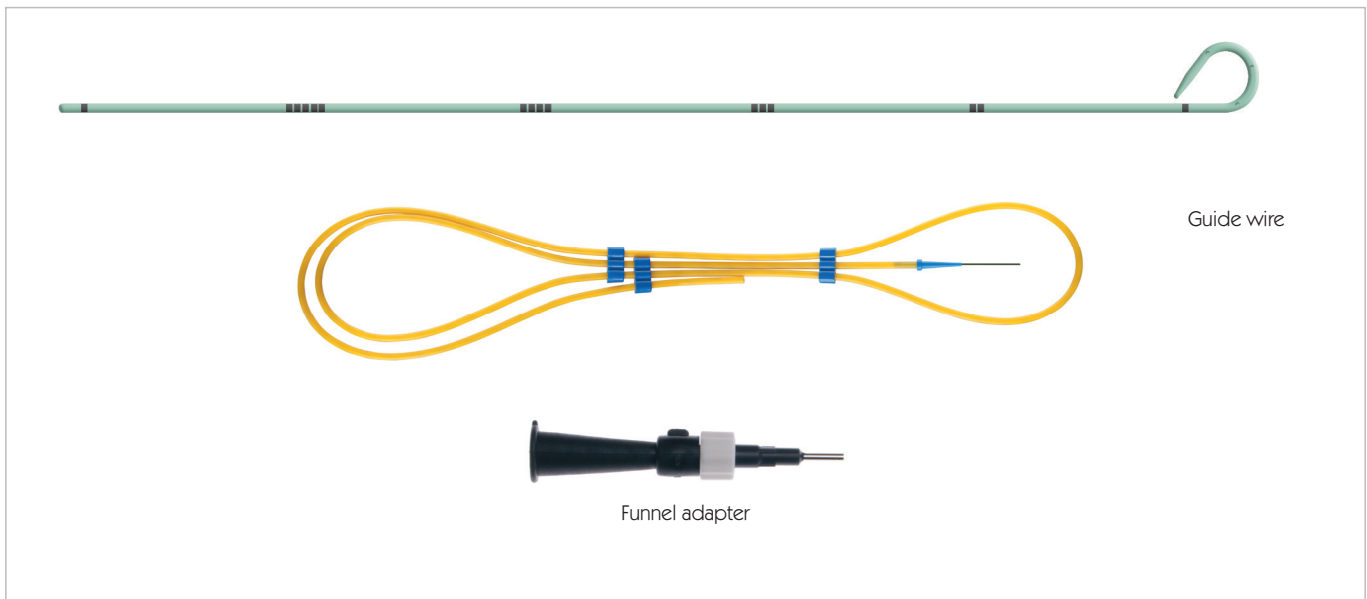

Ureteral Stent

- ◆ Polyurethane
- ◆ Especially soft material to ensure a high level of patient comfort
- ◆ Drainage openings only available for pigtail
- ◆ Open tip
- ◆ Markings for exact positioning

◆ Radiopaque

Guide wire

◆ PTFE coating

Adapter

◆ For attaching to the urine drainage bag

Open tip							
Order number with guide wire	Order number without guide wire	Size (CH/FR)	Length (cm)	Wire (inch)	Wire length (cm)	Wire tip	Wire stiffness
ST-350600	ST-357600	6	70	0.035"	150	straight	standard
ST-350700	ST-357700	7	70	0.035"	150	straight	standard
ST-350800	ST-357800	8	70	0.038"	150	straight	standard
ST-350900	ST-357900	9	70	0.038"	150	straight	standard

SPECIAL VISIOSTENT TUMOR STENT Double-J Ureteral Stent Set

DESCRIPTION

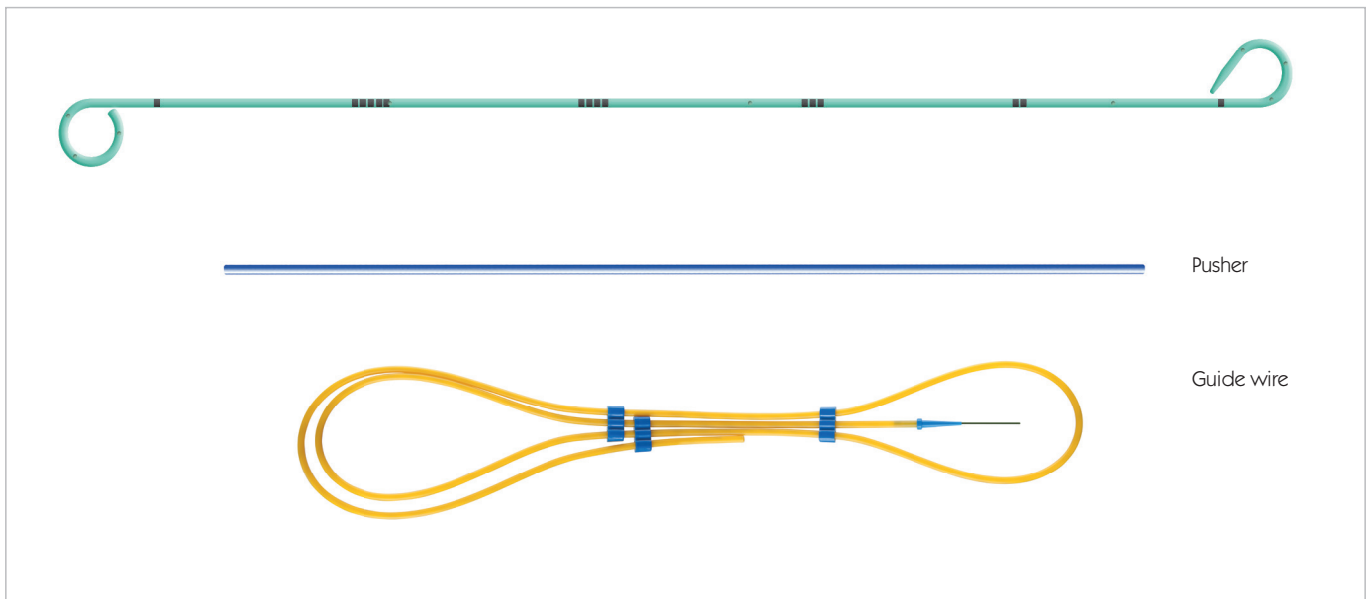

Ureteral Stent

- ◆ Polyurethane
- ◆ Produced from a single piece, so it is not possible for the pigtail to loosen
- ◆ Stable shaft for maximal pressure resistance
- ◆ Soft pigtails for improved wearing comfort
- ◆ No drainage openings in the shaft, to prevent infiltration of tumor tissue growth
- ◆ Open tip
- ◆ Markings for exact positioning
- ◆ Radiopaque

Pusher

- ◆ Length: 40 cm

Guide wire

- ◆ PTFE coating

SPECIAL VISIOSTENT TUMOR STENT Double-J Ureteral Stent Set

Open tip						
Order number with guide wire	Size (CH/FR)	Length (cm)	Wire (inch)	Wire length (cm)	Wire tip	Wire stiffness
TS-290624	6	24	0.035"	150	straight	standard
TS-290626	6	26	0.035"	150	straight	standard
TS-290628	6	28	0.035"	150	straight	standard
TS-290630	6	30	0.035"	150	straight	standard
TS-290724	7	24	0.035"	150	straight	standard
TS-290726	7	26	0.035"	150	straight	standard
TS-290728	7	28	0.035"	150	straight	standard
TS-290730	7	30	0.035"	150	straight	standard
TS-290824	8	24	0.038"	150	straight	standard
TS-290826	8	26	0.038"	150	straight	standard
TS-290828	8	28	0.038"	150	straight	standard
TS-290830	8	30	0.038"	150	straight	standard
TS-290924	9	24	0.038"	150	straight	standard
TS-290926	9	26	0.038"	150	straight	standard
TS-290928	9	28	0.038"	150	straight	standard
TS-290930	9	30	0.038"	150	straight	standard

Variants with sutures on the bladder end are available on request.

VISIOMATIC® TUMOR STENT Double-J Ureteral Stent Set Steerable with VISIOMATIC® Discharge System

DESCRIPTION

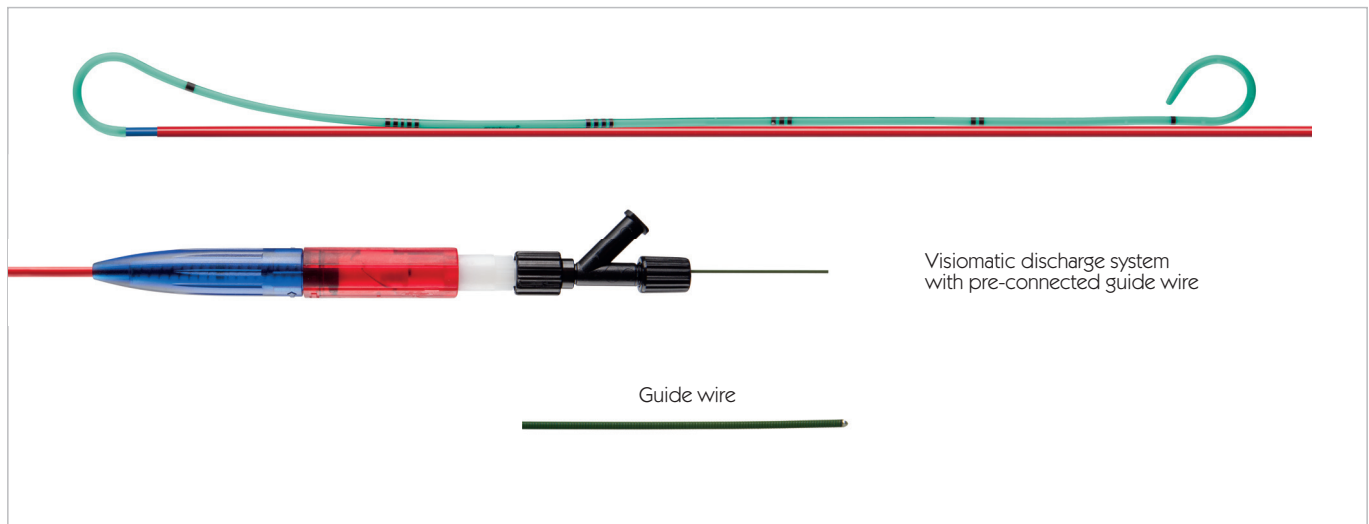

Ureteral Stent

- ◆ Polyurethane
- ◆ Produced from a single element
- ◆ Stable shaft for maximal pressure resistance
- ◆ Soft pigtails for improved wearing comfort
- ◆ No drainage openings in the shaft, to prevent infiltration of tumor tissue growth
- ◆ Open tip
- ◆ Markings for exact positioning
- ◆ Radiopaque

Visiomatic Discharge System

- ◆ Pusher
- ◆ Disconnecter
- ◆ Y-adapter with crimp coupling for securing the guide wire
- ◆ Length: 51 cm

Guide wire

- ◆ PTFE coating

SPECIAL STENTS

VISIOMATIC TUMOR STENT Double-J Ureteral Stent Set Steerable with VISIOMATIC® Discharge System

Open tip						
Order number with guide wire	Size (CH/FR)	Length (cm)	Wire (inch)	Wire length (cm)	Wire tip	Wire stiffness
TS-110624-V	6	24	0.035"	150	straight	standard
TS-110626-V	6	26	0.035"	150	straight	standard
TS-110628-V	6	28	0.035"	150	straight	standard
TS-110630-V	6	30	0.035"	150	straight	standard
TS-110724-V	7	24	0.035"	150	straight	standard
TS-110726-V	7	26	0.035"	150	straight	standard
TS-110728-V	7	28	0.035"	150	straight	standard
TS-110730-V	7	30	0.035"	150	straight	standard
TS-110824-V	8	24	0.038"	150	straight	standard
TS-110826-V	8	26	0.038"	150	straight	standard
TS-110828-V	8	28	0.038"	150	straight	standard
TS-110830-V	8	30	0.038"	150	straight	standard
TS-110924-V	9	24	0.038"	150	straight	standard
TS-110926-V	9	26	0.038"	150	straight	standard
TS-110928-V	9	28	0.038"	150	straight	standard
TS-110930-V	9	30	0.038"	150	straight	standard

ONKOVISION® TUMOR STENT Double-J Ureteral Stent Set With a stainless steel helix

DESCRIPTION

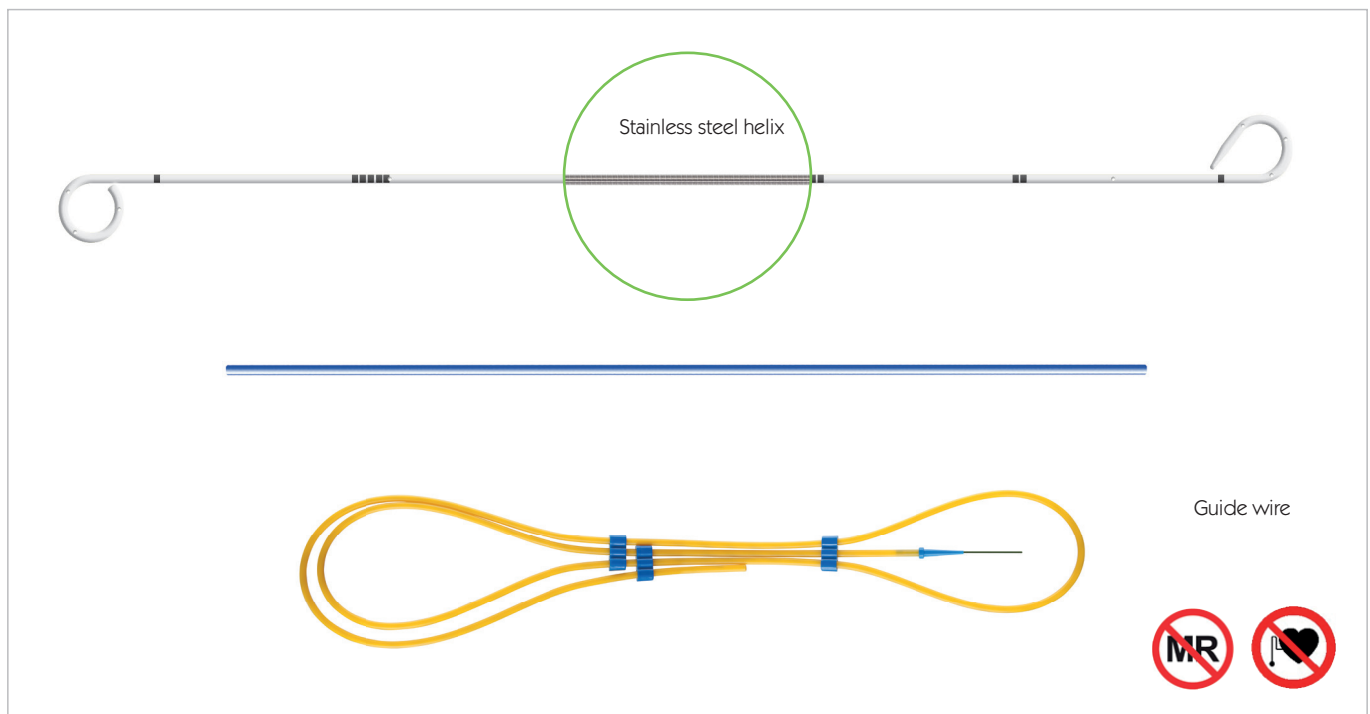

Ureteral Stent

- ◆ Polyurethane
- ◆ Highly flexible stainless steel helix for maximal pressure resistance with minimal ureter irritation
- ◆ Soft pigtails for improved wearing comfort
- ◆ No drainage openings in the shaft, to prevent infiltration of tumor tissue growth
- ◆ Open tip
- ◆ Markings for exact positioning
- ◆ Radiopaque

Pusher

- ◆ Length: 40 cm

Guide wire

- ◆ PTFE coating

SPECIAL STENTS

ONKOVISION® TUMOR STENT Double-J Ureteral Stent Set

With a stainless steel helix

Open tip						
Order number with guide wire	Size (CH/FR)	Length (cm)	Wire (inch)	Wire length (cm)	Wire tip	Wire stiffness
TS-310624	6	24	0.032"	150	straight	standard
TS-310626	6	26	0.032"	150	straight	standard
TS-310628	6	28	0.032"	150	straight	standard
TS-310630	6	30	0.032"	150	straight	standard
TS-310724	7	24	0.035"	150	straight	standard
TS-310726	7	26	0.035"	150	straight	standard
TS-310728	7	28	0.035"	150	straight	standard
TS-310730	7	30	0.035"	150	straight	standard
TS-310824	7	24	0.035"	150	straight	standard
TS-310826	8	26	0.035"	150	straight	standard
TS-310828	8	28	0.035"	150	straight	standard
TS-310830	8	30	0.035"	150	straight	standard

Closed tip						
Order number with guide wire	Size (CH/FR)	Length (cm)	Wire (inch)	Wire length (cm)	Wire tip	Wire stiffness
TS-300624	6	24	0.032"	150	straight	standard
TS-300626	6	26	0.032"	150	straight	standard
TS-300628	6	28	0.032"	150	straight	standard
TS-300630	6	30	0.032"	150	straight	standard
TS-300724	7	24	0.035"	150	straight	standard
TS-300726	7	26	0.035"	150	straight	standard
TS-300728	7	28	0.035"	150	straight	standard
TS-300730	7	30	0.035"	150	straight	standard
TS-300824	8	24	0.035"	150	straight	standard
TS-300826	8	26	0.035"	150	straight	standard
TS-300828	8	28	0.035"	150	straight	standard
TS-300830	8	30	0.035"	150	straight	standard

ONKOVISION® TUMOR STENT Double-J Ureteral Stent Set

With a stainless steel helix

Steerable with VISIOMATIC® discharge system

DESCRIPTION

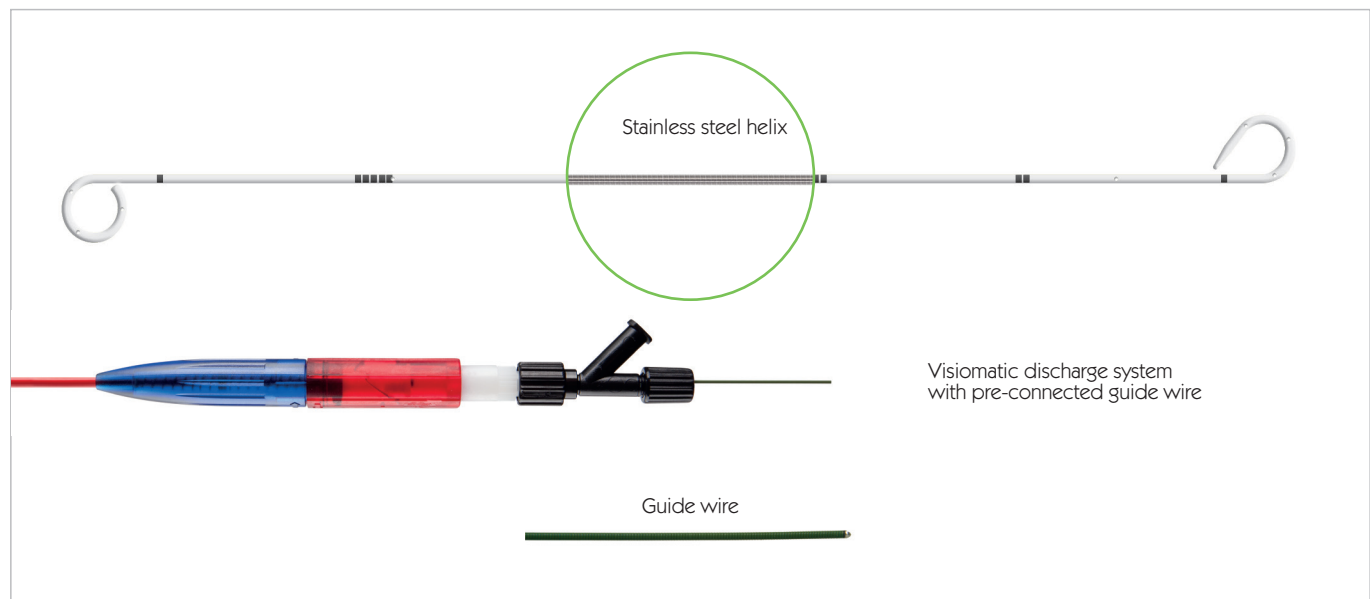

Ureteral Stent

- ◆ Polyurethane
- ◆ Highly flexible stainless steel helix in the shaft for maximal pressure resistance with minimal ureter irritation
- ◆ Soft pigtails for improved wearing comfort
- ◆ No drainage openings in the shaft, to prevent infiltration of tumor tissue growth
- ◆ Open tip
- ◆ Markings for exact positioning
- ◆ Radiopaque

Visiomatic Discharge System

- ◆ Pusher
- ◆ Disconnector
- ◆ Y-adaptor with crimp coupling for securing the guide wire
- ◆ Length: 51 cm

Guide wire

- ◆ PTFE coating

SPECIAL STENTS

ONKOVISION® TUMOR STENT Double-J Ureteral Stent Set

With a stainless steel helix

Steerable with VISIOMATIC® discharge system

Open tip						
Order number with guide wire	Size (CH/FR)	Length (cm)	Wire (inch)	Wire length (cm)	Wire tip	Wire stiffness
TS-330624	6	24	0.032"	150	straight	standard
TS-330626	6	26	0.032"	150	straight	standard
TS-330628	6	28	0.032"	150	straight	standard
TS-330630	6	30	0.032"	150	straight	standard
TS-330724	7	24	0.035"	150	straight	standard
TS-330726	7	26	0.035"	150	straight	standard
TS-330728	7	28	0.035"	150	straight	standard
TS-330730	7	30	0.035"	150	straight	standard
TS-330824	8	24	0.035"	150	straight	standard
TS-330826	8	26	0.035"	150	straight	standard
TS-330828	8	28	0.035"	150	straight	standard
TS-330830	8	30	0.035"	150	straight	standard

Closed tip						
Order number with guide wire	Size (CH/FR)	Length (cm)	Wire (inch)	Wire length (cm)	Wire tip	Wire stiffness
TS-320624	6	24	0.032"	150	straight	standard
TS-320626	6	26	0.032"	150	straight	standard
TS-320628	6	28	0.032"	150	straight	standard
TS-320630	6	30	0.032"	150	straight	standard
TS-320724	7	24	0.035"	150	straight	standard
TS-320726	7	26	0.035"	150	straight	standard
TS-320728	7	28	0.035"	150	straight	standard
TS-320730	7	30	0.035"	150	straight	standard
TS-320824	8	24	0.035"	150	straight	standard
TS-320826	8	26	0.035"	150	straight	standard
TS-320828	8	28	0.035"	150	straight	standard
TS-320830	8	30	0.035"	150	straight	standard

VISIOSTAR ESWL Double-J Ureteral Stent Set

With special profile

DESCRIPTION

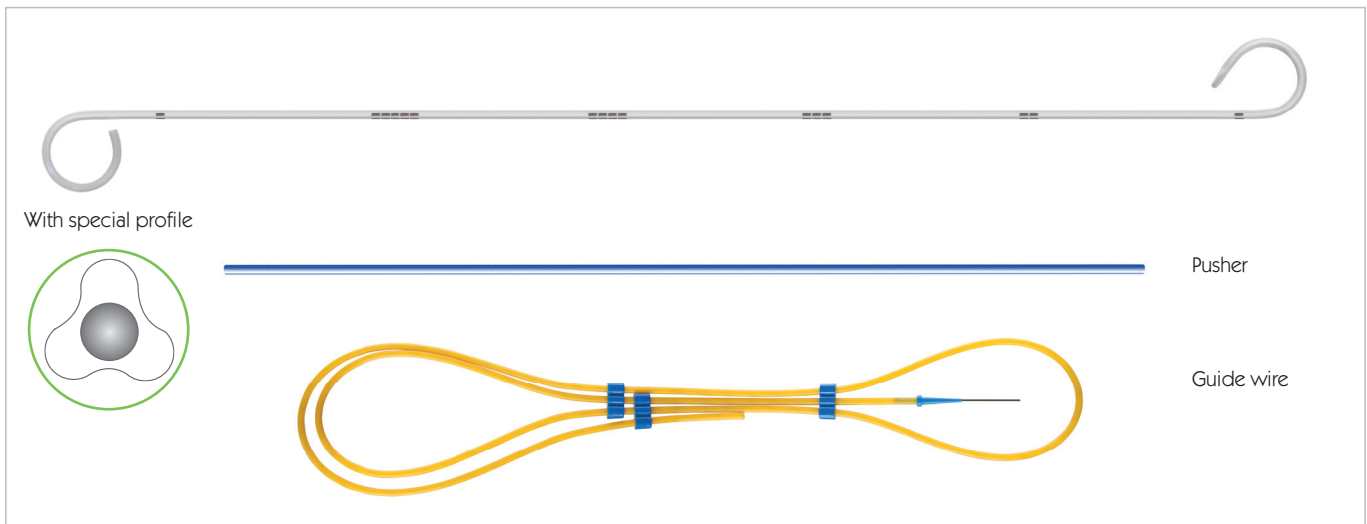

Ureteral Stent

- ◆ Polyurethane
- ◆ Special profile to support discharge of stones
- ◆ Drainage openings only in pigtails
- ◆ Open or closed tip
- ◆ Markings for exact positioning
- ◆ Radiopaque

Pusher

- ◆ Length: 40 cm

Guide wire

- ◆ PTFE coating

Clip

- ◆ In sets with closed tip



Open tip						
Order number with guide wire	Size (CH/FR)	Length (cm)	Wire (inch)	Wire length (cm)	Wire tip	Wire stiffness
ST-230724	7	24	0.035"	150	straight	standard
ST-230726	7	26	0.035"	150	straight	standard
ST-230728	7	28	0.035"	150	straight	standard
ST-230730	7	30	0.035"	150	straight	standard

Closed tip						
Order number with guide wire	Size (CH/FR)	Length (cm)	Wire (inch)	Wire length (cm)	Wire tip	Wire stiffness
ST-220724	7	24	0.035"	150	straight	standard
ST-220726	7	26	0.035"	150	straight	standard
ST-220728	7	28	0.035"	150	straight	standard
ST-220730	7	30	0.035"	150	straight	standard

VISIOSTAR INTRAOPERATIVE Double-J Ureteral Stent Set

DESCRIPTION

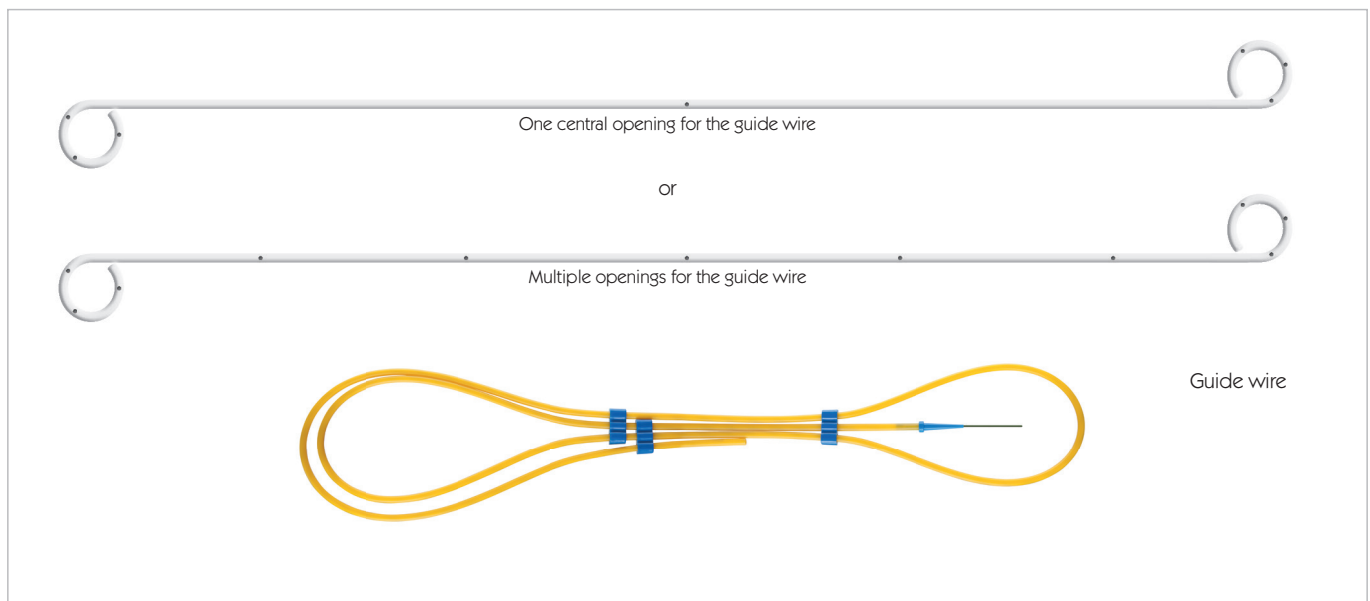

Ureteral Stent

- ◆ Polyurethane
- ◆ Shaft opening central or throughout
- ◆ Closed tip on both ends
- ◆ Radiopaque

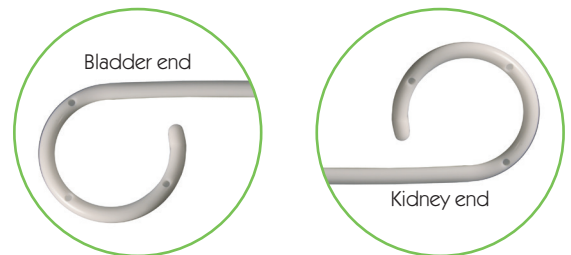

Pusher

- ◆ Length: 40 cm

Guide wire

- ◆ PTFE coating

SPECIAL STENTS

Central opening for guide wire – closed tip						
Order number with guide wire	Size (CH/FR)	Length (cm)	Wire (inch)	Wire length (cm)	Wire tip	Wire stiffness
ST-260524	4.7	24	0.028"	100	straight	standard
ST-260526	4.7	26	0.028"	100	straight	standard
ST-260528	4.7	28	0.028"	100	straight	standard
ST-260530	4.7	30	0.028"	100	straight	standard
ST-260624	6	24	0.035"	100	straight	standard
ST-260626	6	26	0.035"	100	straight	standard
ST-260628	6	28	0.035"	100	straight	standard
ST-260630	6	30	0.035"	100	straight	standard
ST-260724	7	24	0.035"	100	straight	standard
ST-260726	7	26	0.035"	100	straight	standard
ST-260728	7	28	0.035"	100	straight	standard
ST-260730	7	30	0.035"	100	straight	standard
ST-260824	8	24	0.038"	100	straight	standard
ST-260826	8	26	0.038"	100	straight	standard
ST-260828	8	28	0.038"	100	straight	standard
ST-260830	8	30	0.038"	100	straight	standard
ST-260924	9	24	0.038"	100	straight	standard
ST-260926	9	26	0.038"	100	straight	standard
ST-260928	9	28	0.038"	100	straight	standard
ST-260930	9	30	0.038"	100	straight	standard

Multiple openings for guide wire – closed tip						
Order number with guide wire	Size (CH/FR)	Length (cm)	Wire (inch)	Wire length (cm)	Wire tip	Wire stiffness
ST-270524	4.7	24	0.028"	100	straight	standard
ST-270526	4.7	26	0.028"	100	straight	standard
ST-270528	4.7	28	0.028"	100	straight	standard
ST-270530	4.7	30	0.028"	100	straight	standard
ST-270624	6	24	0.035"	100	straight	standard
ST-270626	6	26	0.035"	100	straight	standard
ST-270628	6	28	0.035"	100	straight	standard
ST-270630	6	30	0.035"	100	straight	standard
ST-270724	7	24	0.035"	100	straight	standard
ST-270726	7	26	0.035"	100	straight	standard
ST-270728	7	28	0.035"	100	straight	standard
ST-270730	7	30	0.035"	100	straight	standard
ST-270824	8	24	0.038"	100	straight	standard
ST-270826	8	26	0.038"	100	straight	standard
ST-270828	8	28	0.038"	100	straight	standard
ST-270830	8	30	0.038"	100	straight	standard
ST-270924	9	24	0.038"	100	straight	standard
ST-270926	9	26	0.038"	100	straight	standard
ST-270928	9	28	0.038"	100	straight	standard
ST-270930	9	30	0.038"	100	straight	standard

Additional sizes available on request.

VISIOSTENT STENOSIS Double-J Ureteral Stent Set

Partial shaft reinforcement

DESCRIPTION

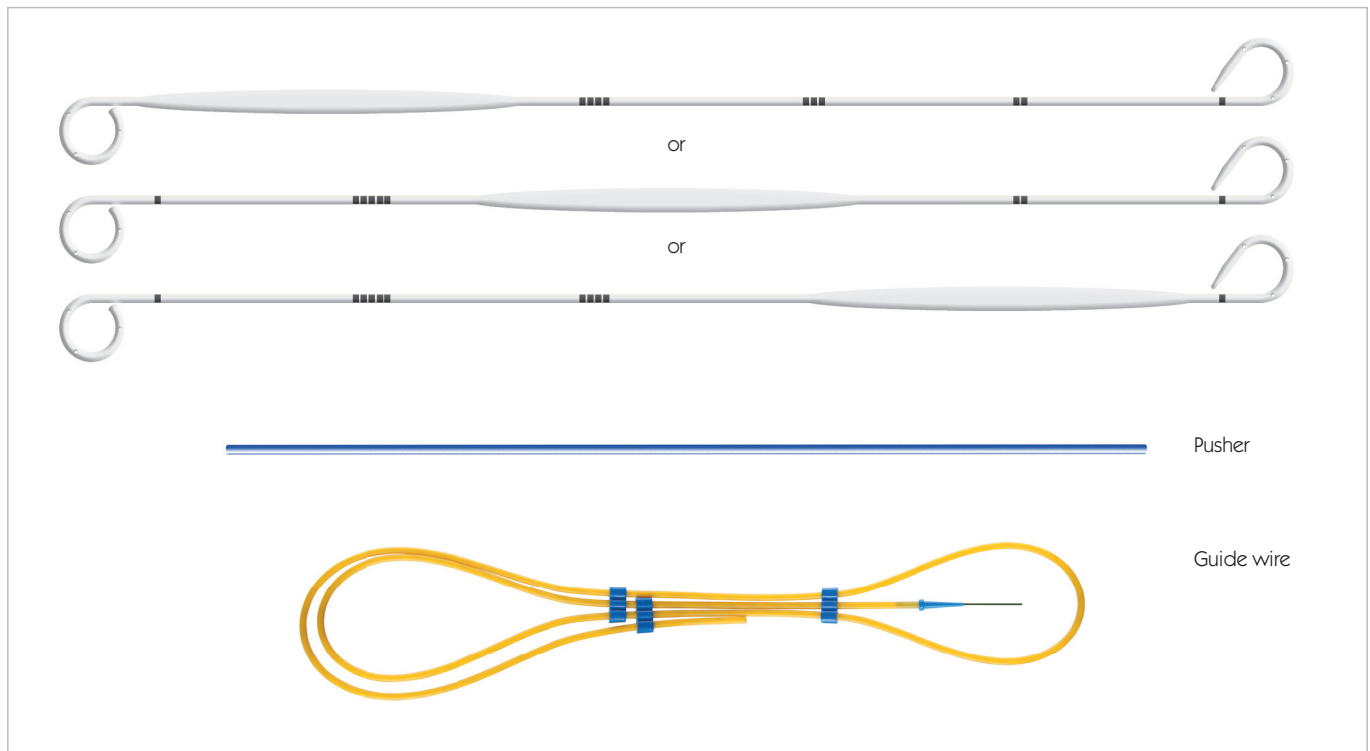

Ureteral Stent

- ◆ Polyurethane
- ◆ Partial reinforcement (proximal, central, distal) for dilatation of stenosis
- ◆ Drainage openings only in pigtails
- ◆ Open tip
- ◆ Markings for exact positioning
- ◆ Radiopaque

Pusher

- ◆ Length: 40 cm

Guide wire

- ◆ PTFE coating

SPECIAL STENTS

Bladder-end reinforcement – open tip							
Order number with guide wire	Size (CH/FR)	Shaft reinforcement (CH/FR)	Length (cm)	Wire (inch)	Wire length (cm)	Wire tip	Wire stiffness
TP-291226	7	12	26	0.038"	150	straight	standard
TP-291228	7	12	28	0.038"	150	straight	standard
TP-291230	7	12	30	0.038"	150	straight	standard

Central reinforcement – open tip							
Order number with guide wire	Size (CH/FR)	Shaft reinforcement (CH/FR)	Length (cm)	Wire (inch)	Wire length (cm)	Wire tip	Wire stiffness
TM-291226	7	12	26	0.038"	150	straight	standard
TM-291228	7	12	28	0.038"	150	straight	standard
TM-291230	7	12	30	0.038"	150	straight	standard

Kidney-end reinforcement – open tip							
Order number with guide wire	Size (CH/FR)	Shaft reinforcement (CH/FR)	Length (cm)	Wire (inch)	Wire length (cm)	Wire tip	Wire stiffness
TD-291226	7	12	26	0.038"	150	straight	standard
TD-291228	7	12	28	0.038"	150	straight	standard
TD-291230	7	12	30	0.038"	150	straight	standard

VISIOFLUX ANTI-REFLUX STENT Double-J Ureteral Stent set

With anti-reflux valve, steerable with VISIOMATIC® discharge system

DESCRIPTION

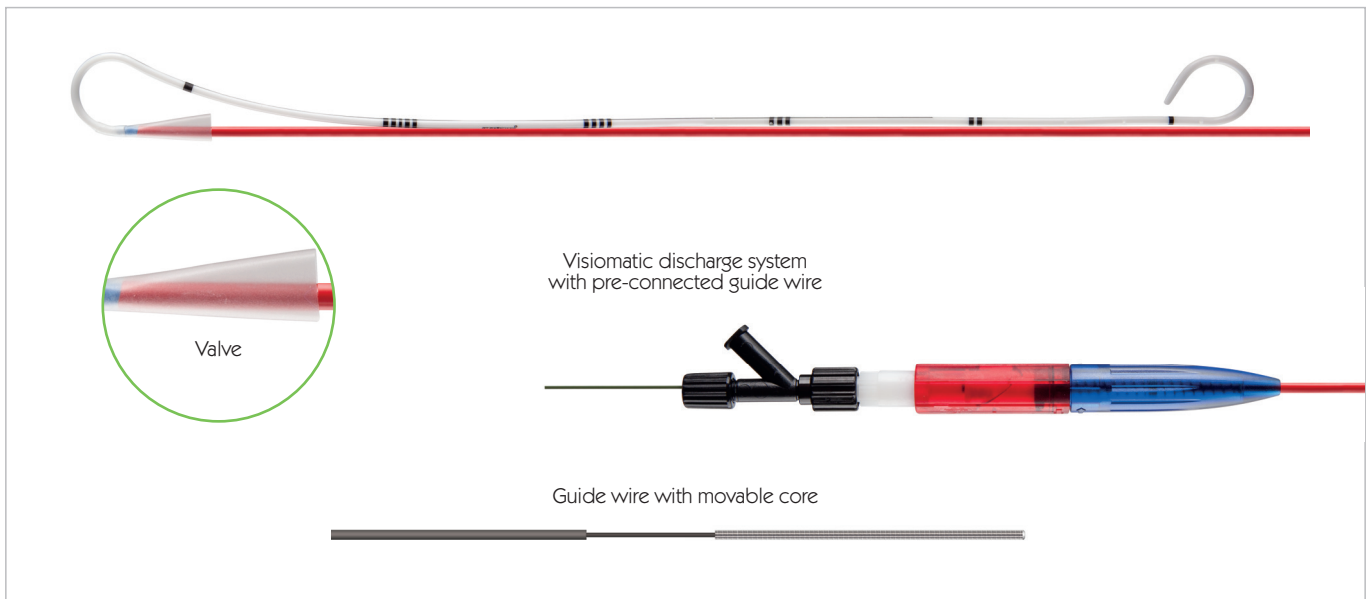

Ureteral Stent

- ◆ Polyurethane
- ◆ Anti-reflux valve at distal/bladder end prevents backflow of urine into the ureter
- ◆ Drainage openings in shaft and pigtail only at bladder end/distal
- ◆ Open tip
- ◆ Markings for exact positioning
- ◆ Radiopaque

Visiomatic Discharge System

- ◆ Pusher
- ◆ Disconnector
- ◆ Y-adapter with crimp coupling for securing the guide wire
- ◆ Length: 51 cm

Guide wire

- ◆ PTFE coating

Open tip						
Order number with guide wire	Size (CH/FR)	Length (cm)	Wire (inch)	Wire length (cm)	Wire tip	Wire stiffness
UF-110624	6	24	0.035"	150	straight	standard/movable core
UF-110626	6	26	0.035"	150	straight	standard/movable core
UF-110628	6	28	0.035"	150	straight	standard/movable core
UF-110630	6	30	0.035"	150	straight	standard/movable core
UF-110724	7	24	0.035"	150	straight	standard/movable core
UF-110726	7	26	0.035"	150	straight	standard/movable core
UF-110728	7	28	0.035"	150	straight	standard/movable core
UF-110730	7	30	0.035"	150	straight	standard/movable core
UF-110824	8	24	0.038"	150	straight	standard
UF-110826	8	26	0.038"	150	straight	standard
UF-110828	8	28	0.038"	150	straight	standard
UF-110830	8	30	0.038"	150	straight	standard

VISIOFLUX Single-J Ureteral Stent set For reducing bladder irritation

DESCRIPTION

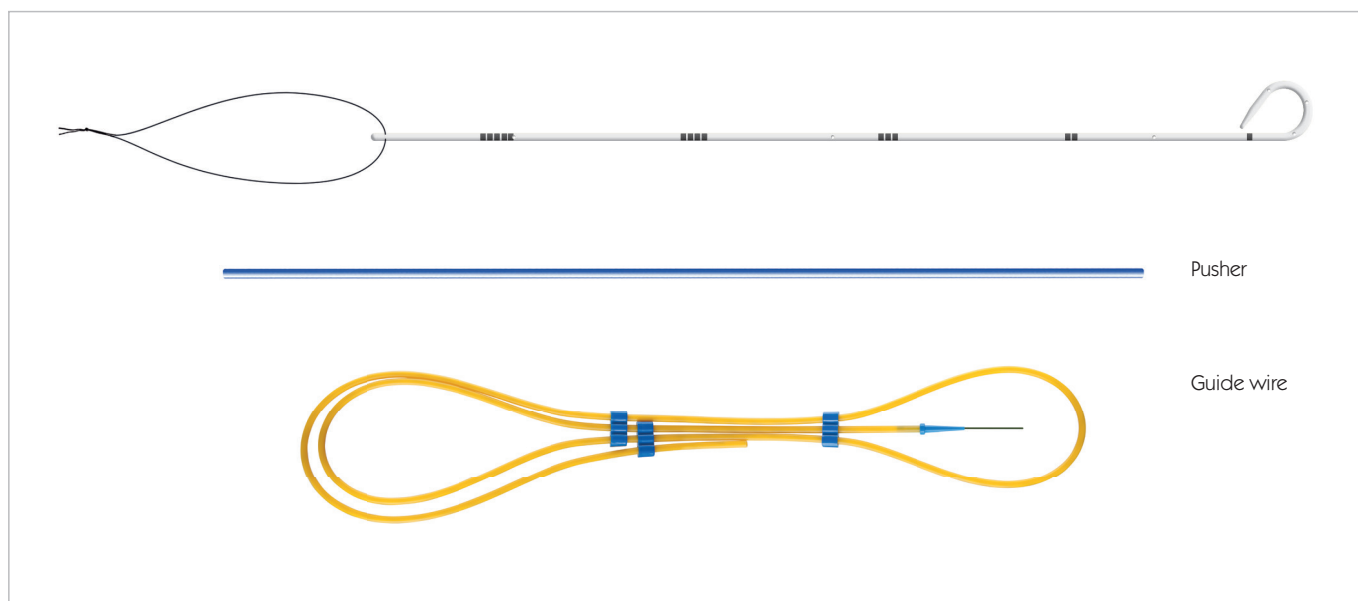

Ureteral Stent

- ◆ Polyurethane
- ◆ Thanks to the optimal length of the stent, which ends before the ostium, irritations in the bladder and ostium are prevented
- ◆ Pigtail only at kidney end/proximal
- ◆ With suture at the straight end, which stays in the bladder
- ◆ Drainage openings in shaft and pigtail
- ◆ Open or closed tip
- ◆ Markings for exact positioning
- ◆ Radiopaque

Pusher

- ◆ Length: 40 cm

Guide wire

- ◆ PTFE coating

SPECIAL STENTS

VISIOFLUX Single-J Ureteral Stent set

For reducing bladder irritation

Open tip						
Order number with guide wire	Size (CH/FR)	Length (cm)	Wire (inch)	Wire length (cm)	Wire tip	Wire stiffness
FL-930622	6	22	0.035"	150	straight	standard
FL-930624	6	24	0.035"	150	straight	standard
FL-930626	6	26	0.035"	150	straight	standard
FL-930722	7	22	0.035"	150	straight	standard
FL-930724	7	24	0.035"	150	straight	standard
FL-930726	7	26	0.035"	150	straight	standard
FL-930822	8	22	0.038"	150	straight	standard
FL-930824	8	24	0.038"	150	straight	standard
FL-930826	8	26	0.038"	150	straight	standard

Closed tip						
Order number with guide wire	Size (CH/FR)	Length (cm)	Wire (inch)	Wire length (cm)	Wire tip	Wire stiffness
FL-920622	6	22	0.035"	150	straight	standard
FL-920624	6	24	0.035"	150	straight	standard
FL-920626	6	26	0.035"	150	straight	standard
FL-920722	7	22	0.035"	150	straight	standard
FL-920724	7	24	0.035"	150	straight	standard
FL-920726	7	26	0.035"	150	straight	standard
FL-920822	8	22	0.038"	150	straight	standard
FL-920824	8	24	0.038"	150	straight	standard
FL-920826	8	26	0.038"	150	straight	standard

INTUBATION STENT Double-J Ureteral Stent Set

Partial shaft thickening, also in the pigtails

DESCRIPTION

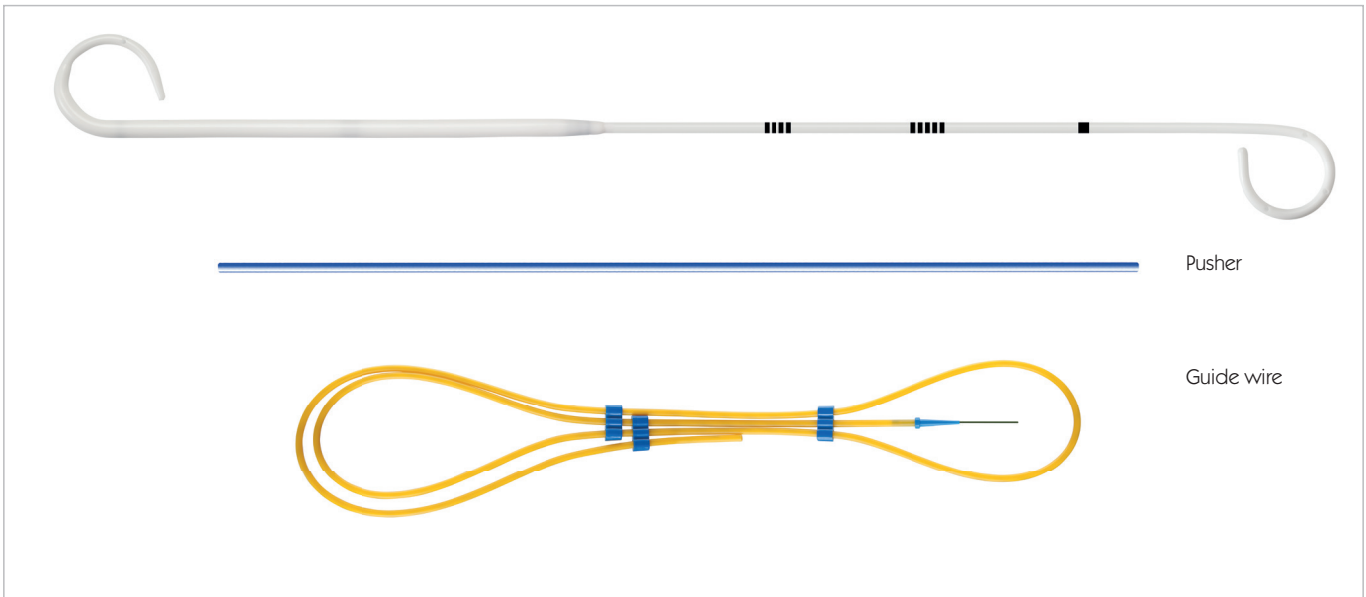

Ureteral Stent

- ◆ Polyurethane
- ◆ Partial reinforcement (proximal, distal) for dilatation of stenosis
- ◆ Drainage openings only in pigtails
- ◆ Open tip
- ◆ Markings for exact positioning
- ◆ Radiopaque

Pusher

- ◆ Length: 40 cm

Guide wire

- ◆ PTFE coating

Bladder-end reinforcement – open tip – for antegrade application

Order number with guide wire	Size (CH/FR)	Shaft reinforcement (CH/FR)	Length (cm)	Wire (inch)	Wire length (cm)	Wire tip	Wire stiffness
SI-301226	7	12	26	0.038"	150	straight	standard
SI-301228	7	12	28	0.038"	150	straight	standard
SI-301230	7	12	30	0.038"	150	straight	standard

Kidney-end reinforcement – open tip – for retrograde application

Order number with guide wire	Size (CH/FR)	Shaft reinforcement (CH/FR)	Length (cm)	Wire (inch)	Wire length (cm)	Wire tip	Wire stiffness
SI-291226	7	12	26	0.038"	150	straight	standard
SI-291228	7	12	28	0.038"	150	straight	standard
SI-291230	7	12	30	0.038"	150	straight	standard

PYELOPLASTY CATHETERS

For pyeloplasty

DESCRIPTION

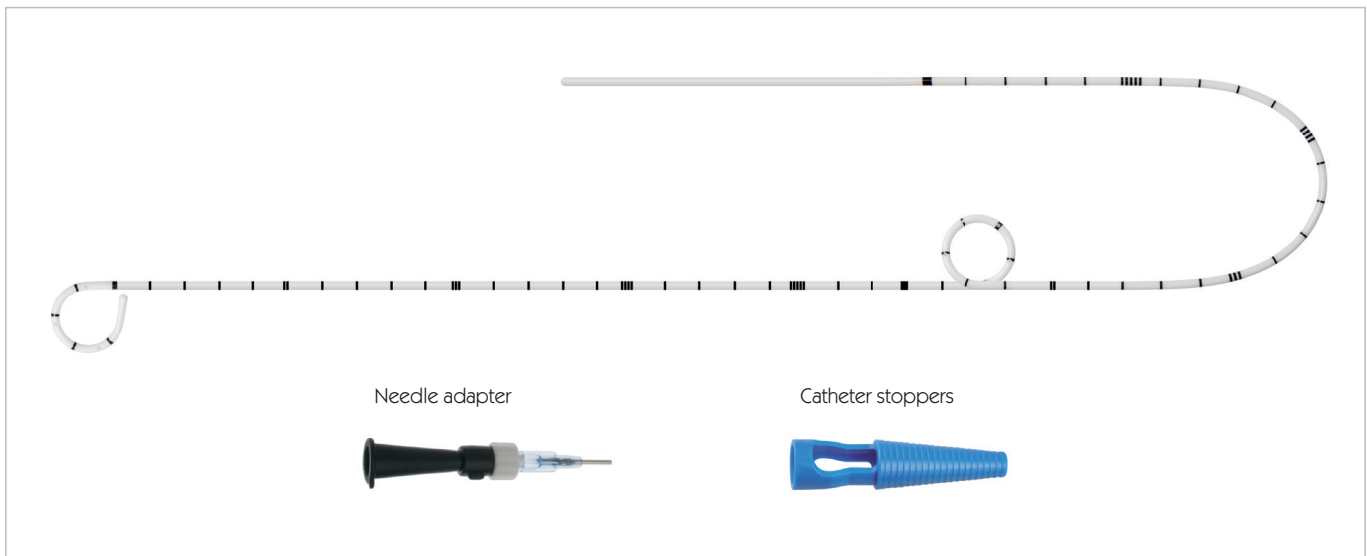

Catheter

- ◆ Polyurethane
- ◆ Drainage openings in pigtail and ureter section
- ◆ With straight tip or pigtail
- ◆ Open tip
- ◆ Markings for exact positioning
- ◆ Radiopaque

Adapter

- ◆ For attachment to the urine drainage bag

With straight tip					
Order number	Size (CH/FR)	Length (cm)	Length of ureter section (cm)	Length of drainage section (cm)	Maximum guide wire
UR-910675	6	75	20	50	0.035"
UR-910775	7	75	20	50	0.035"
UR-910875	8	75	20	50	0.038"

With pigtail					
Order number	Size (CH/FR)	Length (cm)	Length of ureter section (cm)	Length of drainage section (cm)	Maximum guide wire
UR-930628	6	75	28	35	0.035"
UR-930728	7	75	28	35	0.035"

VISIO-WEB STANDARD

For supraventricular urinary diversion

DESCRIPTION



Ureteral Stent

- ◆ Polyurethane
- ◆ Transparent material with x-ray contrast strips and plastic stylet
- ◆ 5 drainage openings at the proximal end for unimpeded urine discharge
- ◆ Open or closed tip
- ◆ Markings for exact positioning
- ◆ Application e.g. following neobladder formation



Adapter

- ◆ Funnel adapter for rinsing or attachment of urine drainage bag

Closed tip			
Order number	Size (CH/FR)	Length (cm)	Maximum guide wire
WB-104	4	80	0.025"
WB-105	5	80	0.035"
WB-106	6	80	0.035"
WB-107	7	80	0.035"
WB-108	8	80	0.038"
WB-109	9	80	0.038"
WB-110	10	80	0.045"
WB-112	12	80	0.045"

Open tip			
Order number	Size (CH/FR)	Length (cm)	Maximum guide wire
WB-904	4	80	0.025"
WB-905	5	80	0.035"
WB-906	6	80	0.035"
WB-907	7	80	0.035"
WB-908	8	80	0.038"
WB-909	9	80	0.045"
WB-910	10	80	0.045"

VISIO-WEB SOFT

For supraventricular urinary diversion

DESCRIPTION

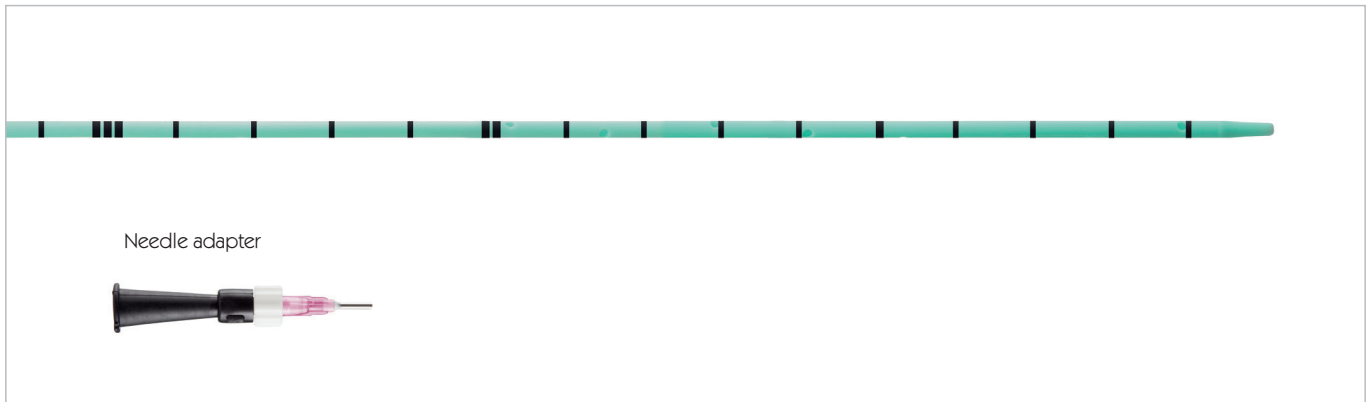

Ureteral Stent

- ◆ Polyurethane
- ◆ Soft material with x-ray contrast strips and plastic stylet
- ◆ 5 drainage openings at the kidney end for unimpeded urine discharge
- ◆ Closed tip
- ◆ Markings for exact positioning
- ◆ Application e.g. following neobladder formation

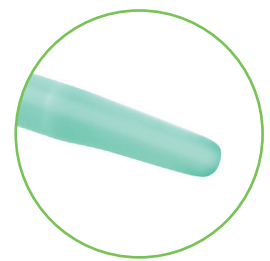

Adapter

- ◆ Funnel adapter for rinsing or attachment of urine drainage bag

Closed tip			
Order number	Size (CH/FR)	Length (cm)	Maximum guide wire
WB-206	6	80	0.038"
WB-207	7	80	0.038"
WB-208	8	80	0.038"

VISIOSTAR COMPLETE SET Double-J Ureteral Stent Set with Ureteral Catheter

DESCRIPTION

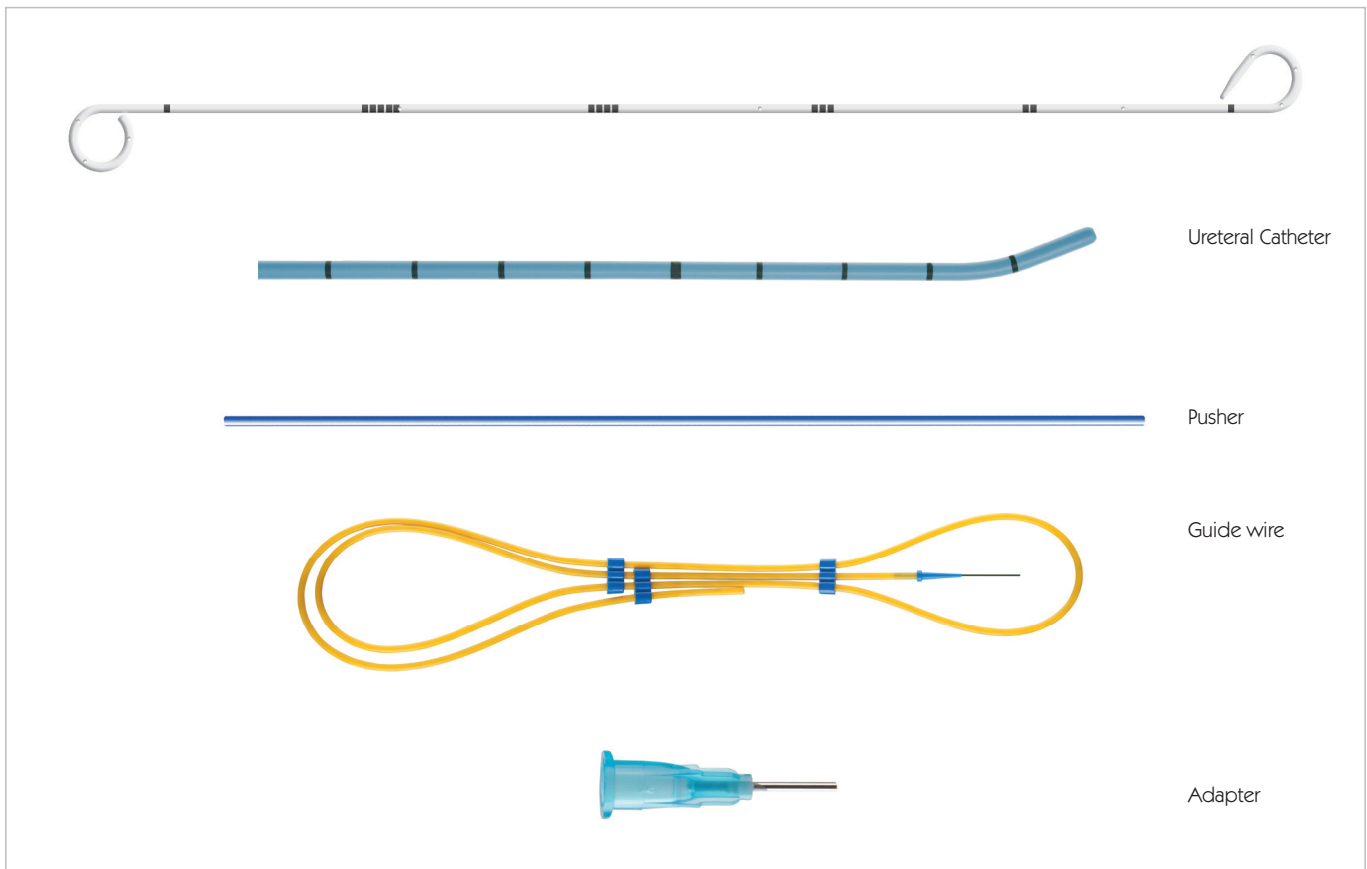

Ureteral Catheter

Pusher

Guide wire

Adapter

Ureteral Stent

- ◆ Polyurethane
- ◆ Drainage openings in pigtails and shaft
- ◆ Open tip
- ◆ Markings for exact positioning
- ◆ Radiopaque

Ureteral Catheter

- ◆ Made of Pebax with stainless steel stylet
- ◆ Open Tiemann tip
- ◆ Size: CH/FR 4.7
- ◆ Length: 70 cm

Pusher

- ◆ Length: 40 cm

Guide wire

- ◆ PTFE coating

Adapter

- ◆ Cannula adapter

SPECIAL STENTS

VISIOSTAR COMPLETE SET Double-J Ureteral Stent Set with Ureteral Catheter

Open tip						
Order number with guide wire	Size (CH/FR)	Length (cm)	Wire (inch)	Wire length (cm)	Wire tip	Wire stiffness
ST-186524	4.7	24	0.035"	150	straight	standard
ST-186526	4.7	26	0.035"	150	straight	standard
ST-186528	4.7	28	0.035"	150	straight	standard
ST-186530	4.7	30	0.035"	150	straight	standard
ST-186624	6	24	0.035"	150	straight	standard
ST-186626	6	26	0.035"	150	straight	standard
ST-186628	6	28	0.035"	150	straight	standard
ST-186630	6	30	0.035"	150	straight	standard
ST-186724	7	24	0.035"	150	straight	standard
ST-186726	7	26	0.035"	150	straight	standard
ST-186728	7	28	0.035"	150	straight	standard
ST-186730	7	30	0.035"	150	straight	standard

Also available with sutures on the bladder end.

VISIOLIX COMPLETE SET Double-J Ureteral Stent Set with Ureteral Catheter

DESCRIPTION

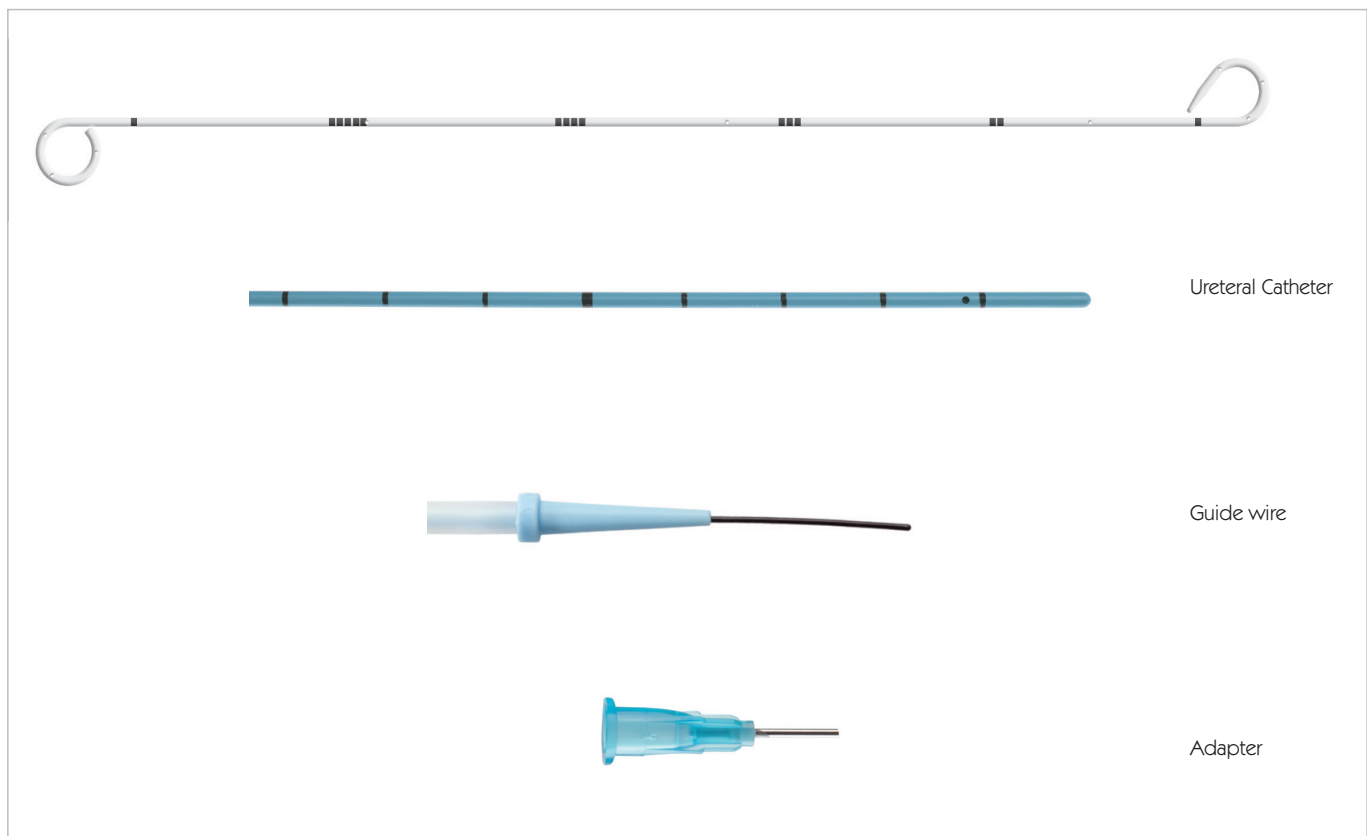

Ureteral Catheter

Guide wire

Adapter

Ureteral Stent

- ◆ Polyurethane
- ◆ Drainage openings in pigtails and shaft
- ◆ Open tip
- ◆ Markings for exact positioning
- ◆ Radiopaque

Ureteral Catheter

- ◆ Made of Pebax with stainless steel stylet
- ◆ Straight, open tip
- ◆ Size: CH/FR 4.7
- ◆ Length: 70 cm

Pusher

- ◆ Length: 40 cm

Guide wire

- ◆ Hydrophilic coating for improved movement – moisten before use in application tube

Adapter

- ◆ Cannula adapter

Wire insertion tool

- ◆ With crimp coupling for securing the guide wire

SPECIAL STENTS

VISIOLIX COMPLETE SET Double-J Ureteral Stent Set with Ureteral Catheter

Open tip						
Order number with guide wire	Size (CH/FR)	Length (cm)	Wire (inch)	Wire length (cm)	Wire tip	Wire stiffness
EL-280522	4.7	22	0.035"	150	straight	stiff
EL-280524	4.7	24	0.035"	150	straight	stiff
EL-280526	4.7	26	0.035"	150	straight	stiff
EL-280528	4.7	28	0.035"	150	straight	stiff
EL-280530	4.7	30	0.035"	150	straight	stiff
EL-280532	4.7	32	0.035"	150	straight	stiff
EL-280534	4.7	34	0.035"	150	straight	stiff
EL-280620	6	20	0.035"	150	straight	stiff
EL-280622	6	22	0.035"	150	straight	stiff
EL-280624	6	24	0.035"	150	straight	stiff
EL-280626	6	26	0.035"	150	straight	stiff
EL-280628	6	28	0.035"	150	straight	stiff
EL-280630	6	30	0.035"	150	straight	stiff
EL-280632	6	32	0.035"	150	straight	stiff
EL-280634	6	34	0.035"	150	straight	stiff
EL-280720	7	20	0.035"	150	straight	stiff
EL-280722	7	22	0.035"	150	straight	stiff
EL-280724	7	24	0.035"	150	straight	stiff
EL-280726	7	26	0.035"	150	straight	stiff
EL-280728	7	28	0.035"	150	straight	stiff
EL-280730	7	30	0.035"	150	straight	stiff
EL-280732	7	32	0.035"	150	straight	stiff
EL-280734	7	34	0.035"	150	straight	stiff

WWW.UROVISION.DE



UROVISION

Medi-Globe-Strasse 1-5
D-83101 Achenmühle,
Germany

☎ +49 (0) 80 32 / 973 - 400
📠 +49 (0) 80 32 / 973 - 411

NEPHROSTOMY



NEPHROSTOMY

RENOVISION Nephrostomy Sets, with Pigtail Catheter	2.1
RENOVISION 2-Step Method	2.2
RENOVISION Nephrostomy, Pigtail Catheters with funnel	2.3
RENOVISION Nephrostomy, Balloon Catheters & Sets	2.4
RENOVISION Catheter Set	2.6
VISIOFIX Renal Cyst Puncture Set	2.7

RENOVISION NEPHROSTOMY Puncture and Exchange Set

With pigtail catheter

SET COMPONENTS

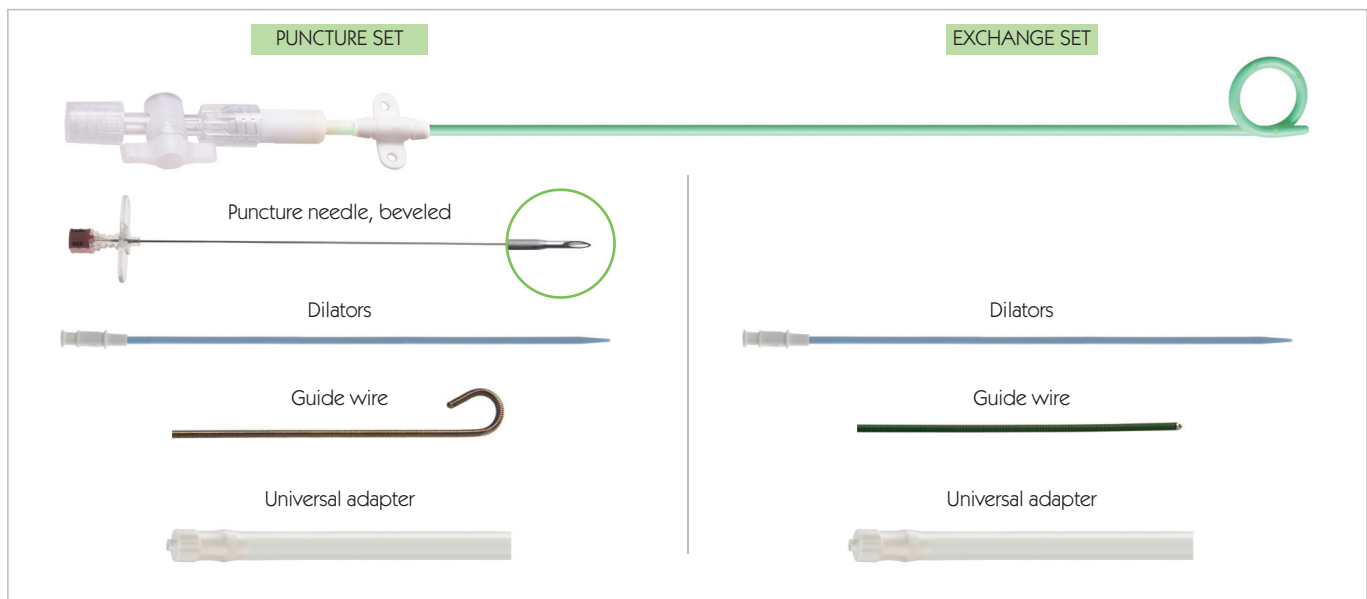

Nephrostomy Catheter

- ◆ Polyurethane
- ◆ Drainage openings in pigtail
- ◆ Luer Lock Connection
- ◆ Optimal radiopaque visibility due to sandblasted tip

Puncture Needle

- ◆ 2-part needle
- ◆ Medical stainless steel
- ◆ 18 G, 19.5 cm in length

Guide Wire (Lunderquist)

- ◆ PTFE coating

Universal Adapter

- ◆ Luer lock connection and silicone tube attachment (parylene coating)
- ◆ Length: 10 cm

RENOVISION NEPHROSTOMY Puncture and Exchange Set with pigtail catheter

Single catheter		
Order number	Size (CH/FR)	Length (cm)
RN-480635	6	30
RN-480645	6	40
RN-480735	7	30
RN-480745	7	40
RN-480835	8	30
RN-480845	8	40
RN-480935	9	30
RN-480945	9	40
RN-481045	10	40
RN-481445	14	40

Puncture Set							
Order number	Size (CH/FR)	Length (cm)	Dilators	Wire (inch)	Wire length (cm)	Wire tip (r=1.5 mm)	Wire stiffness
RN-440635	6	30	05/06/07	0.035"	80	J-tip	stiff
RN-440645	6	40	05/06/07	0.035"	80	J-tip	stiff
RN-440735	7	30	06/07/08	0.035"	80	J-tip	stiff
RN-440745	7	40	06/07/08	0.035"	80	J-tip	stiff
RN-440835	8	30	07/08/09	0.035"	80	J-tip	stiff
RN-440845	8	40	07/08/09	0.035"	80	J-tip	stiff
RN-440935	9	30	08/09/10	0.035"	80	J-tip	stiff
RN-440945	9	40	08/09/10	0.035"	80	J-tip	stiff
RN-441045	10	40	08/10/12	0.035"	80	J-tip	stiff

Exchange Set							
Order number	Size (CH/FR)	Length (cm)	Dilators	Wire (inch)	Wire length (cm)	Wire tip	Wire stiffness
RN-450635	6	30	05/06/07	0.035"	80	straight	stiff
RN-450645	6	40	05/06/07	0.035"	80	straight	stiff
RN-450735	7	30	06/07/08	0.035"	80	straight	stiff
RN-450745	7	40	06/07/08	0.035"	80	straight	stiff
RN-450835	8	30	07/08/09	0.035"	80	straight	stiff
RN-450845	8	40	07/08/09	0.035"	80	straight	stiff
RN-450935	9	30	08/09/10	0.035"	80	straight	stiff
RN-450945	9	40	08/09/10	0.035"	80	straight	stiff
RN-451045	10	40	08/10/12	0.035"	80	straight	stiff

RENOVISION 2-STEP METHOD

With pigtail catheter

SET COMPONENTS

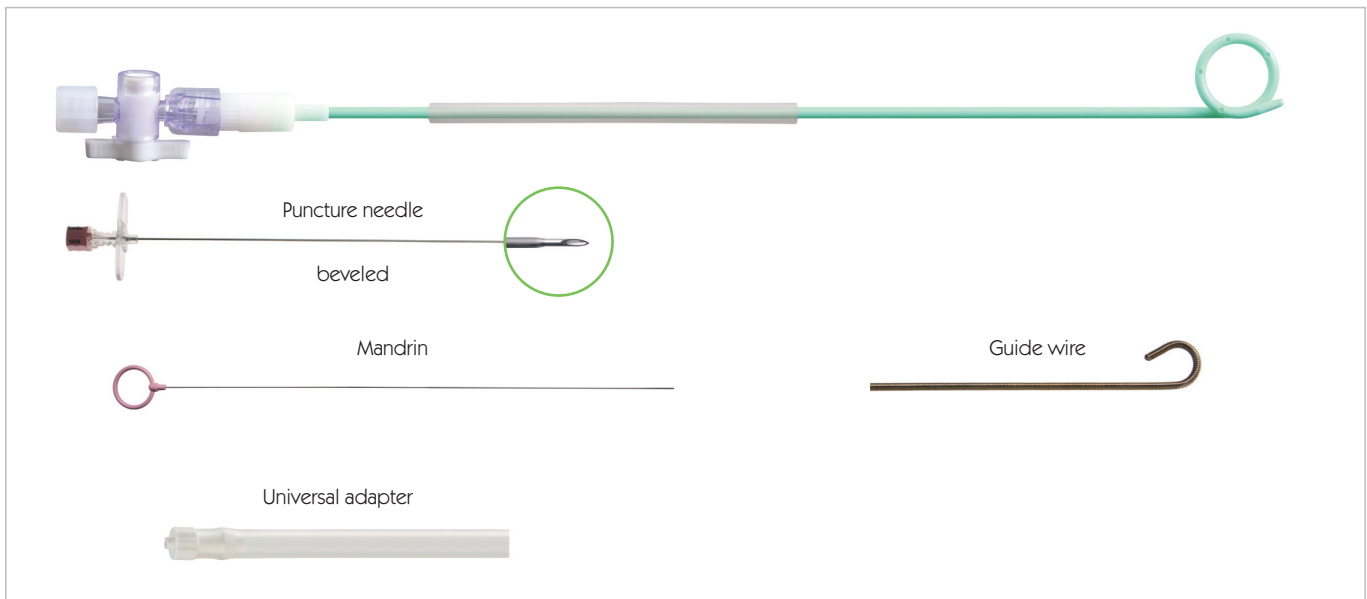

Nephrostomy Catheter

- ◆ Polyurethane
- ◆ Drainage openings in pigtail
- ◆ Stretching tool to facilitate insertion of mandrin and puncture needle
- ◆ Luer Lock Connection
- ◆ Optimal radiopaque visibility due to sandblasted tip

Puncture Needle

- ◆ 2-part needle
- ◆ Medical stainless steel
- ◆ 18 G, 19.5 cm in length

Mandrin

- ◆ Rounded tip to enable safe stretching of catheter

Guide Wire

- ◆ Schüller guide wire – uncoated stainless steel

Universal Adapter

- ◆ Luer lock connection and silicone tube attachment (parylene coating)
- ◆ Length: 10 cm

Two-step method						
Order number	Size (CH/FR)	Length (cm)	Wire (inch)	Wire length (cm)	Wire tip (r=1.5 mm)	Wire stiffness
RN-900835	8	30	0.035"	80	J-tip	stiff
RN-900935	9	30	0.035"	80	J-tip	stiff

RENOVISION NEPHROSTOMY Puncture and Exchange Set with Funnel

SET COMPONENTS

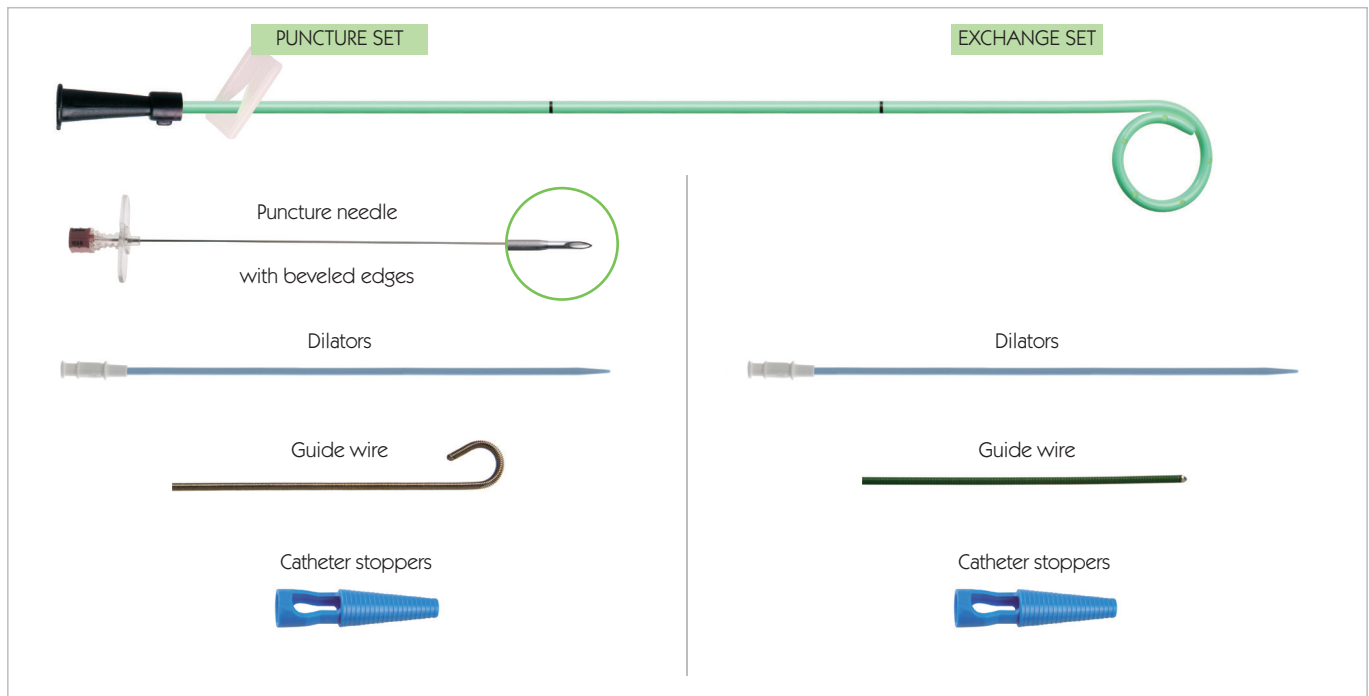

Nephrostomy Catheter

- ◆ Polyurethane
- ◆ Drainage openings in pigtail
- ◆ Funnel for connecting urine bag
- ◆ Optimal radiopaque visibility due to sandblasted tip

Puncture Needle

- ◆ 2-part needle
- ◆ Medical stainless steel
- ◆ 18 G, 19.5 cm in length

Guide Wire (Lunderquist)

- ◆ PTFE coating

NEPHROSTOMY

Single catheter		
Order number	Size (CH/FR)	Length (cm)
RN-501145	11	40
RN-501445	14	40

Puncture Set							
Order number	Size (CH/FR)	Length (cm)	Dilators with split shaft*	Wire (inch)	Wire length (cm)	Wire tip (r=1.5 mm)	Wire stiffness
RN-461140	11	40	08/10/12*	0.035"	80	J-tip	stiff
RN-461240	12	40	09/10/12/14*	0.035"	80	J-tip	stiff
RN-461440	14	40	10/12/14/16*	0.035"	80	J-tip	stiff
RN-461640	16	40	10/12/14/16/18*	0.035"	80	J-tip	stiff
RN-461840	18	40	10/14/18/20*	0.035"	80	J-tip	stiff

Exchange Set							
Order number	Size (CH/FR)	Length (cm)	Dilators with split shaft*	Wire (inch)	Wire length (cm)	Wire tip	Wire stiffness
RN-471140	11	40	08/10/12*	0.035"	80	straight	stiff
RN-471440	14	40	10/12/14/16*	0.035"	80	straight	stiff

RENOVISION-INTEGRAL NEPHROSTOMY

Puncture and Exchange Set

Seldinger method, 100 % silicone, with integrated balloon

SET COMPONENTS

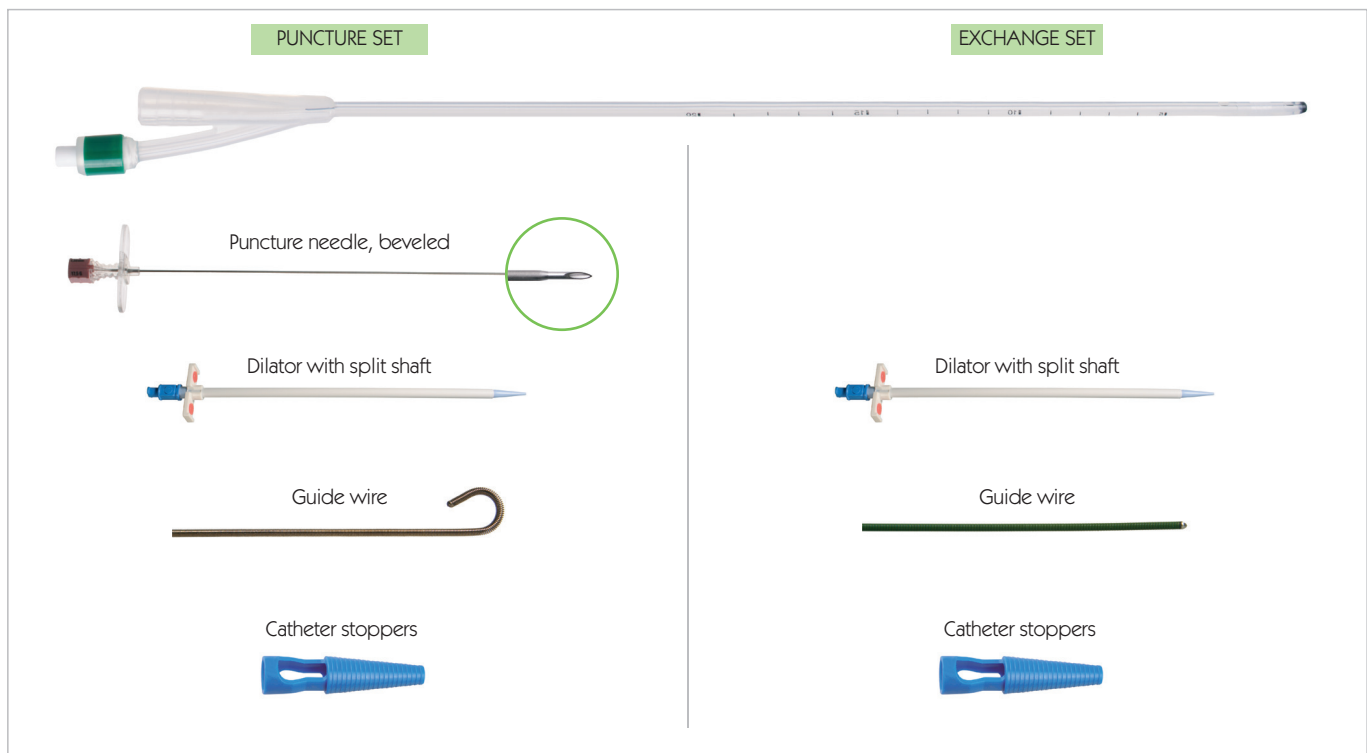

Balloon Catheter

- ◆ Silicone for optimal tissue compatibility
- ◆ Opening behind the balloon for caliceal drainage
- ◆ Integrated balloon
- ◆ X-ray contrast strips
- ◆ Radiopaque, reinforced tip
- ◆ Markings for exact positioning
- ◆ Optimal radiopaque visibility due to sandblasted tip

Puncture Needle

- ◆ 2-part needle
- ◆ Medical stainless steel
- ◆ 18 G, 19.5 cm in length

Guide Wire (Lunderquist)

- ◆ PTFE coating

NEPHROSTOMY

Single catheter			
Order number	Size (CH/FR)	Length (cm)	Balloon (ml)
RN-431026	10	30	1.5
RN-421040	10	40	1.5
RN-431226	12	30	2
RN-421240	12	40	2
RN-431426	14	30	3
RN-421440	14	40	3
RN-431626	16	30	5
RN-421640	16	40	5
RN-431826	18	30	5
RN-421840	18	40	5
RN-432026	20	30	5
RN-422040	20	40	5
RN-422240	22	40	5
RN-422440	24	40	5
RN-422640	26	40	5

Puncture Set								
Order number	Size (CH/FR)	Length (cm)	Balloon (ml)	Dilators* with split shaft	Wire (inch)	Wire length (cm)	Wire tip (r=1.5 mm)	Wire stiffness
RN-401040	10	40	1.5	06/08/10/12*	0.035"	80	J-tip	stiff
RN-401240	12	40	2	08/10/12/14*	0.035"	80	J-tip	stiff
RN-401440	14	40	3	10/12/14/16*	0.035"	80	J-tip	stiff
RN-401640	16	40	5	10/12/14/16/18*	0.035"	80	J-tip	stiff
RN-401840	18	40	5	10/14/18/20*	0.035"	80	J-tip	stiff
RN-402040	20	40	5	10/14/18/22*	0.035"	80	J-tip	stiff
RN-402240	22	40	5	10/14/18/22/24*	0.035"	80	J-tip	stiff

Puncture Set with 3-part Puncture Cannula								
Order number	Size (CH/FR)	Length (cm)	Balloon (ml)	Dilators* with split shaft	Wire (inch)	Wire length (cm)	Wire tip (r=1.5 mm)	Wire stiffness
RN-401250	12	40	2	08/10/12/14*	0.035"	80	J-tip	stiff
RN-401450	14	40	3	08/10/12/14/16*	0.035"	80	J-tip	stiff

Exchange Set								
Order number	Size (CH/FR)	Length (cm)	Balloon (ml)	Dilators* with split shaft	Wire (inch)	Wire length (cm)	Wire tip	Wire stiffness
RN-411040	10	40	1.5	06/08/10/12*	0.035"	80	straight	stiff
RN-411240	12	40	2	08/10/12/14*	0.035"	80	straight	stiff
RN-411440	14	40	3	10/12/14/16*	0.035"	80	straight	stiff
RN-411640	16	40	5	12/14/16/18*	0.035"	80	straight	stiff

RENOVISION-INTEGRAL NEPHROSTOMY

Puncture Set

Seldinger method, 100 % silicone, with integrated balloon

SET COMPONENTS

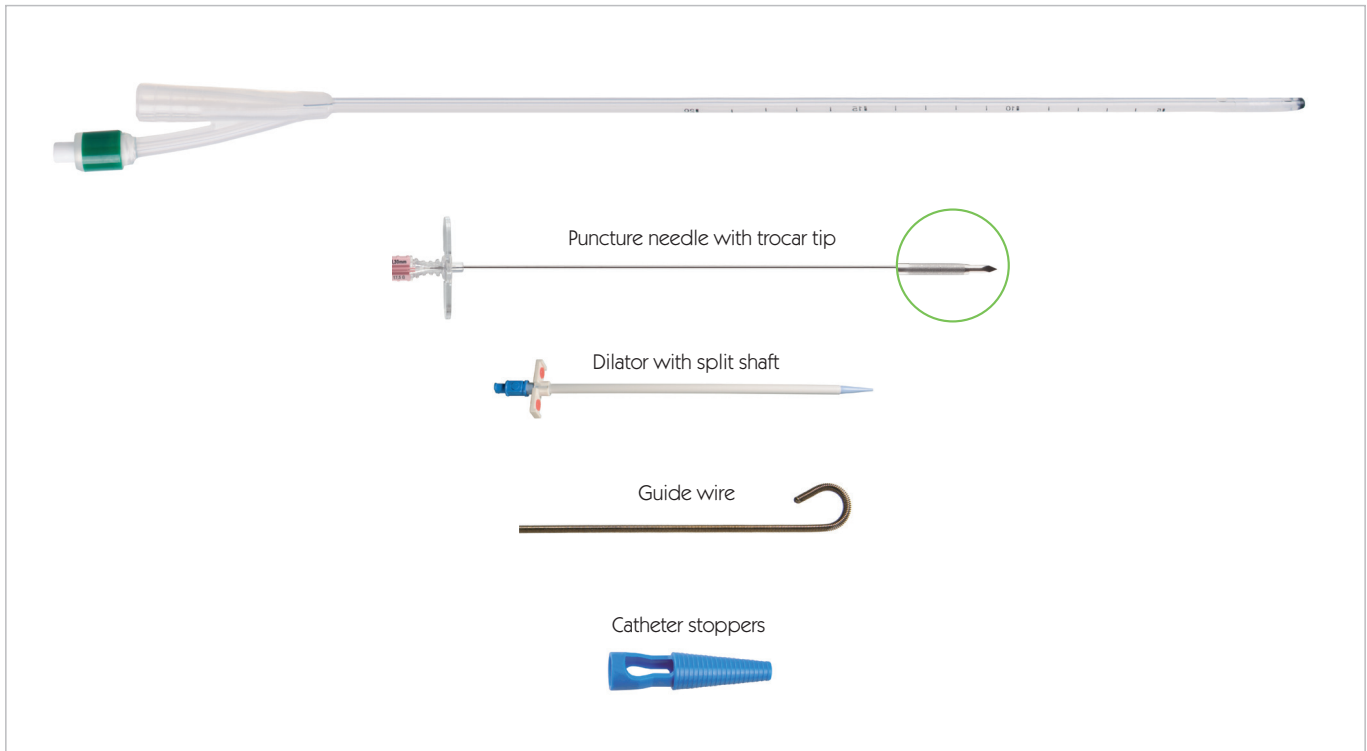

Balloon Catheter

- ◆ Silicone for optimal tissue compatibility
- ◆ Opening behind the balloon for caliceal drainage
- ◆ Integrated balloon
- ◆ X-ray contrast strips
- ◆ Radiopaque, reinforced tip
- ◆ Markings for exact positioning

Puncture Needle

- ◆ 2-part needle with trocar tip
- ◆ Medical stainless steel
- ◆ Optimal radiopaque visibility due to sandblasted tip
- ◆ 18 G, 19.5 cm in length

Guide Wire (Lunderquist)

- ◆ PTFE coating

Puncture Set								
Order number	Size (CH/FR)	Length (cm)	Balloon (ml)	Dilators* with split shaft	Wire (inch)	Wire length (cm)	Wire tip (r=1.5 mm)	Wire stiffness
RN-401240-TR	12	40	2	06/08/10/12*	0.035"	80	J-tip	stiff
RN-401440-TR	14	40	3	08/10/12/14*	0.035"	80	J-tip	stiff

RENOVISION BALLOON CATHETER

100 % silicone, with hollow mandrin, integrated balloon

SET COMPONENTS

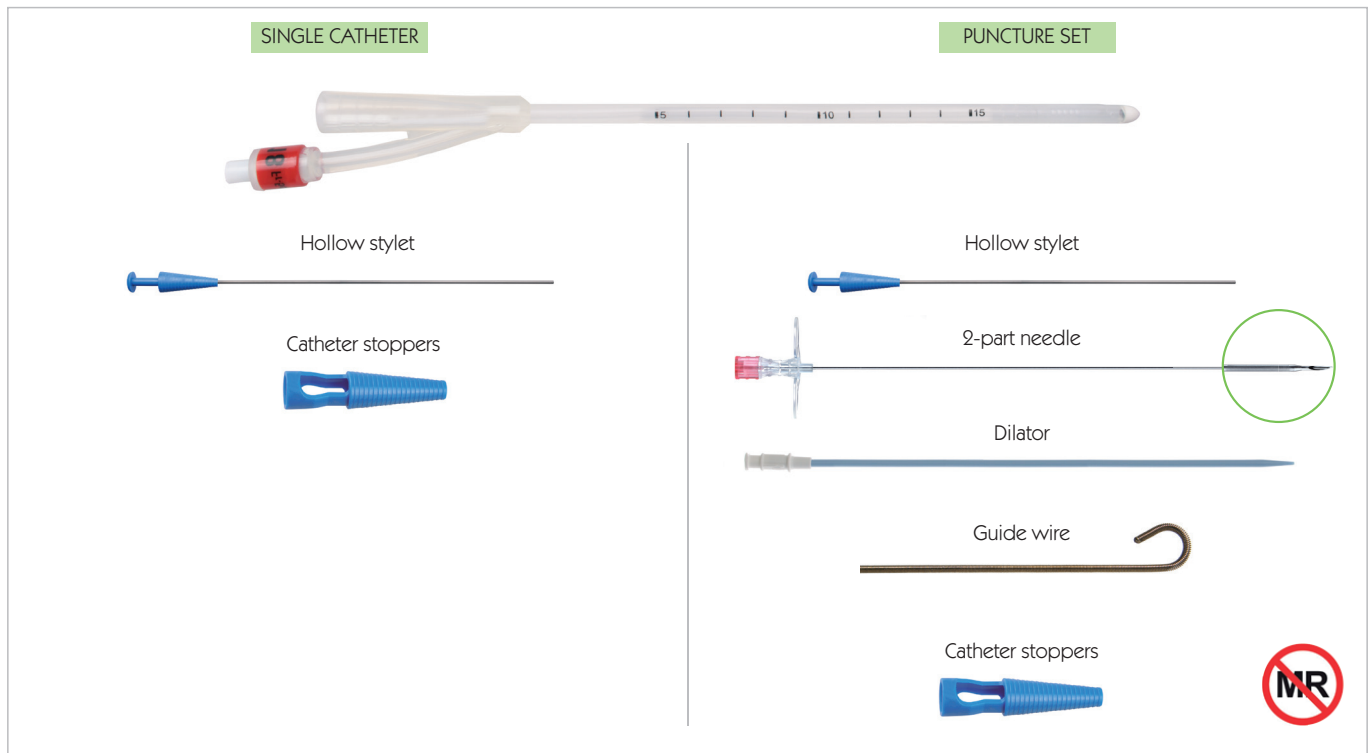

Balloon Catheter

- ◆ Silicone for optimal tissue compatibility
- ◆ Opening behind the balloon for caliceal drainage
- ◆ Integrated balloon
- ◆ Open tip reinforced with metal
- ◆ Markings for exact positioning



Hollow Mandrin

- ◆ For stabilization of the balloon catheter

Puncture Needle

- ◆ 2-part needle
- ◆ Medical stainless steel
- ◆ 18 G, 19.5 cm in length

Guide Wire (Lunderquist)

- ◆ PTFE coating

RENOVISION BALLOON CATHETER

100 % silicone, with hollow mandrin, integrated balloon

Single catheter			
Order number	Size (CH/FR)	Length (cm)	Balloon (ml)
RN-511225	12	25	2
RN-511235	12	40	2
RN-511425	14	25	3
RN-511435	14	40	3
RN-511625	16	25	5
RN-511635	16	40	5
RN-511825	18	25	5
RN-512025	20	25	5
RN-512225	22	25	5

Puncture Set								
Order number	Size (CH/FR)	Length (cm)	Balloon (ml)	Dilators	Wire (inch)	Wire length (cm)	Wire tip (r=1.5 mm)	Wire stiffness
RN-741235	12	40	2	08/10/12	0.035"	80	J-tip	stiff
RN-741435	14	40	3	08/10/12/14	0.035"	80	J-tip	stiff

REINSERTION CATHETER SET

For probing of nephrostomy canal after dislocation of nephrostomy catheter

SET COMPONENTS

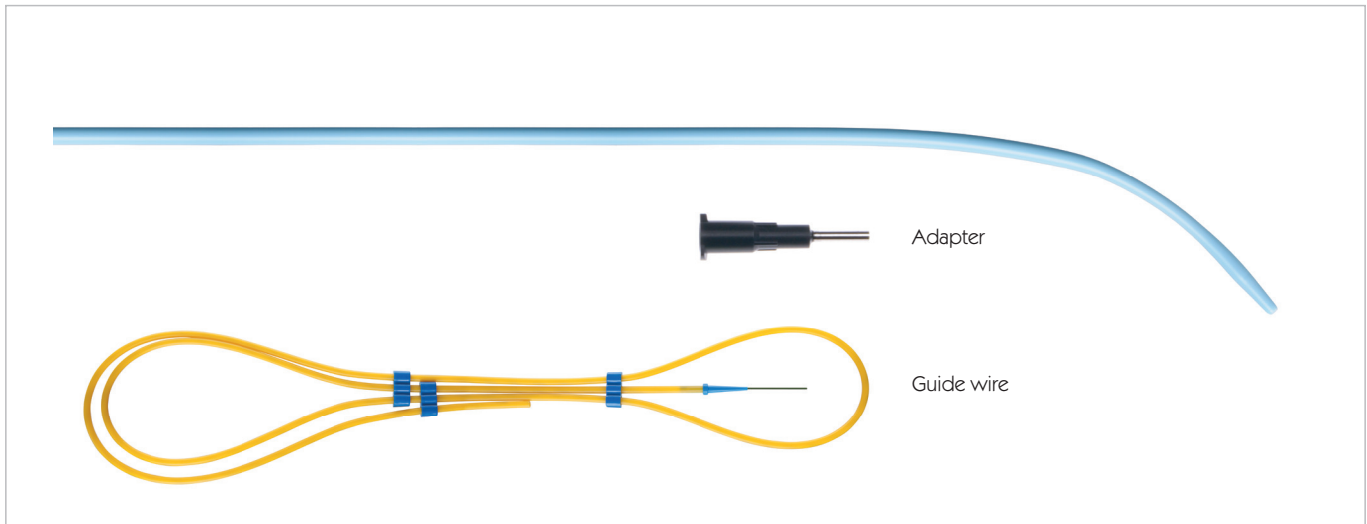

Catheter

- ◆ made of Pebax
- ◆ Angled tip (45°)
- ◆ Open tip
- ◆ Radiopaque

Guide Wire (only in set)

- ◆ PTFE coating

Single catheter			
Order number	Size (CH/FR)	Length (cm)	Maximum guide wire
RN-520650	06	45	0.035"

Set with wire						
Order number	Size (CH/FR)	Length (cm)	Wire length (cm)	Wire diameter	Wire tip	Wire stiffness
RN-520651	06	45	150	0.035"	straight	standard

VISIOFIX RENAL CYST PUNCTURE SET

Straight or with pigtail

SET COMPONENTS

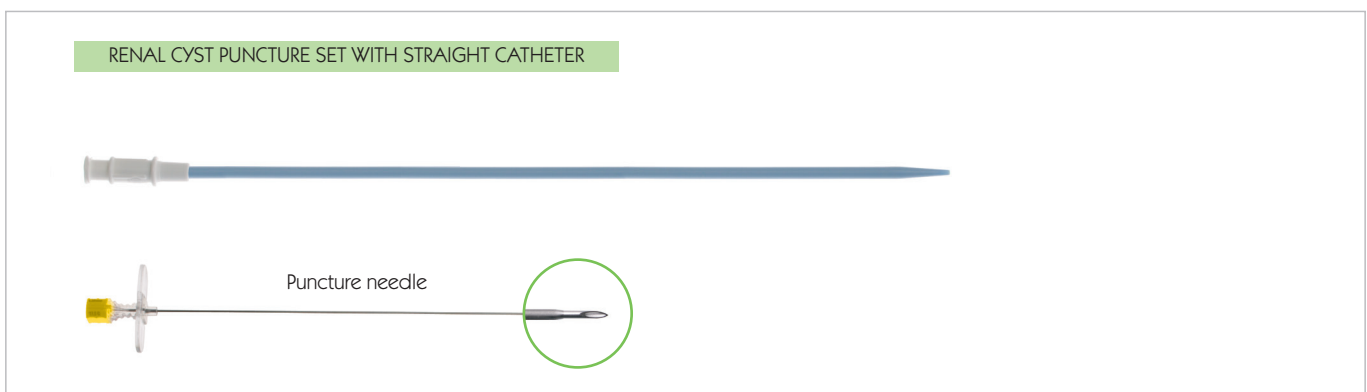
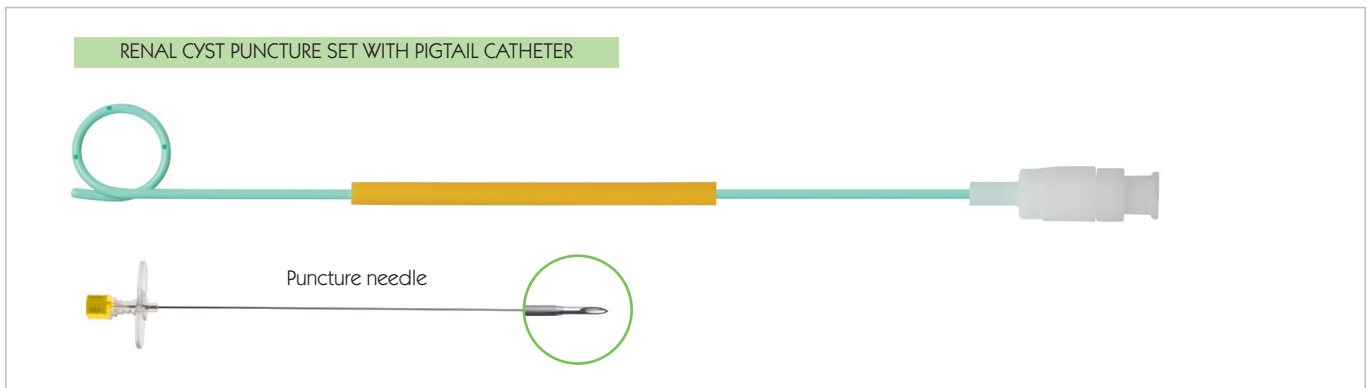

Catheter (with pigtail)

- ◆ Polyurethane, fixed
- ◆ Holes in pigtails
- ◆ Open tip
- ◆ Stretching tool to facilitate insertion of puncture needle in the pigtail catheter
- ◆ Optimal radiopaque visibility due to sandblasted tip

Catheter (straight)

- ◆ Teflon (FEP), extra hard
- ◆ Open tip

Puncture Needle

- ◆ 2-part needle
- ◆ Medical stainless steel
- ◆ 19.5 G

Puncture Set with Pigtail Catheter			
Order number	Size (CH/FR)	Length (cm)	Length of puncture needle (cm)
RN-530525	05	25	26.5

Puncture Set with Straight Catheter			
Order number	Size (CH/FR)	Length (cm)	Length of puncture needle (cm)
RN-540520	05	20	21.5

WWW.UROVISION.DE



UROVISION

Medi-Globe-Strasse 1-5
D-83101 Achenmühle,
Germany

☎ +49 (0) 80 32 / 973 - 400
📠 +49 (0) 80 32 / 973 - 411

STONE BASKETS



VISIOCATCH STONE BASKETS

Super-elastic Nitinol core enclosed in a highly elastic polyamide tube*

"TIPLESS"*



- ◆ Nitinol core enclosed
- ◆ Flexible tip for good maneuverability in the renal pelvis region
- ◆ High tensile strength, and good pressure and torque stability resulting from lasered baskets
- ◆ Handle can be disconnected and reconnected
- ◆ Optimal kink-resistance due to metal-reinforced inner tube
- ◆ Ergonomic scissor grip for easy handling
- ◆ The basket for the greatest demands

Order number	Size (CH/FR)	Wires	Operating length (cm)	Basket length (mm)	Basket diameter (mm)
DO-99194120	1.9	4	120	15	11



- ◆ Fine stone basket without tip for flexible ureterorenoscopy
- ◆ For catching the smallest stones, even at the tissue edge
- ◆ Ergonomical pincer grip providing tensile pressure relief
- ◆ High tensile strength, and good pressure and torque stability due to especially stable wires twisted together at the neck of the basket

Order number	Size (CH/FR)	Wires	Operating length (cm)	Basket length (mm)	Basket diameter (mm)
DO-99194120-ES	1.9	4	120	21	12

VISIOCATCH STONE BASKETS

Super-elastic Nitinol

"HELICAL"



Order number	Size (CH/FR)	Wires	Operating length (cm)	Basket length (mm)	Basket diameter (mm)	Tip length (mm)
DO-925485	2.5	4	90	39	12	3
DO-903475	3.0	4	90	40	12	3
DO-903575	3.0	5	90	40	12	3
DO-9034120	3.0	4	120	40	12	3
DO-904475	4.0	4	90	45	15	3
DO-904575	5.0	5	90	45	15	3

"FLEX TIP"



Order number	Size (CH/FR)	Wires	Operating length (cm)	Basket length (mm)	Basket diameter (mm)	Tip length (mm)
DO-903490-FS	3.0	4	90	39	12	40

VISIOCATCH STONE BASKETS

Super-elastic Nitinol

"STRAIGHT"



Order number	Size (CH/FR)	Wires	Operating length (cm)	Basket length (mm)	Basket diameter (mm)	Tip length (mm)
DO-953490	3.0	4	90	38	12	3
DO-954490	4.0	4	90	43	14	3

URETERAL CATHETER

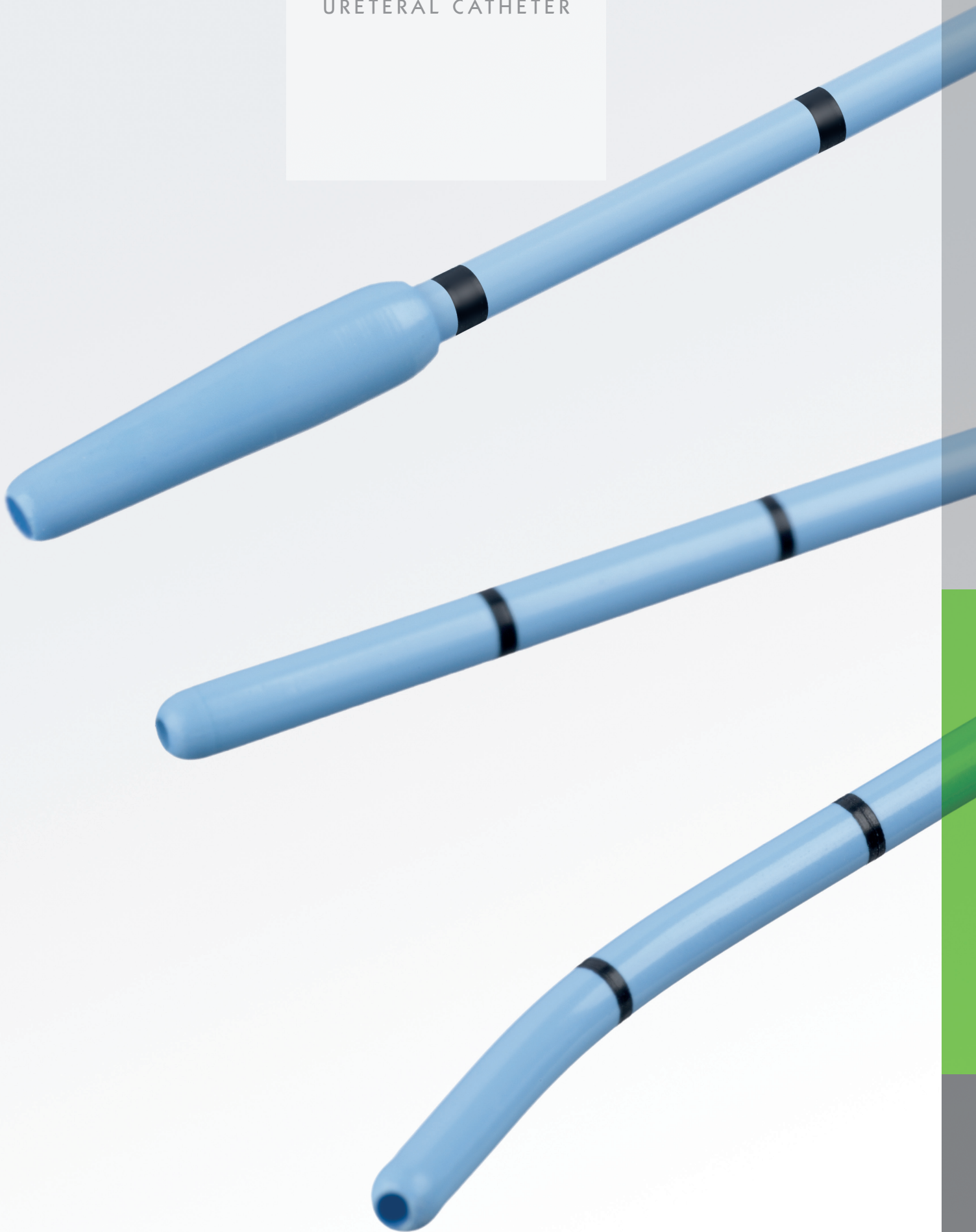

URETERAL CATHETER

VISION URETERAL CATHETER

For retrograde urography

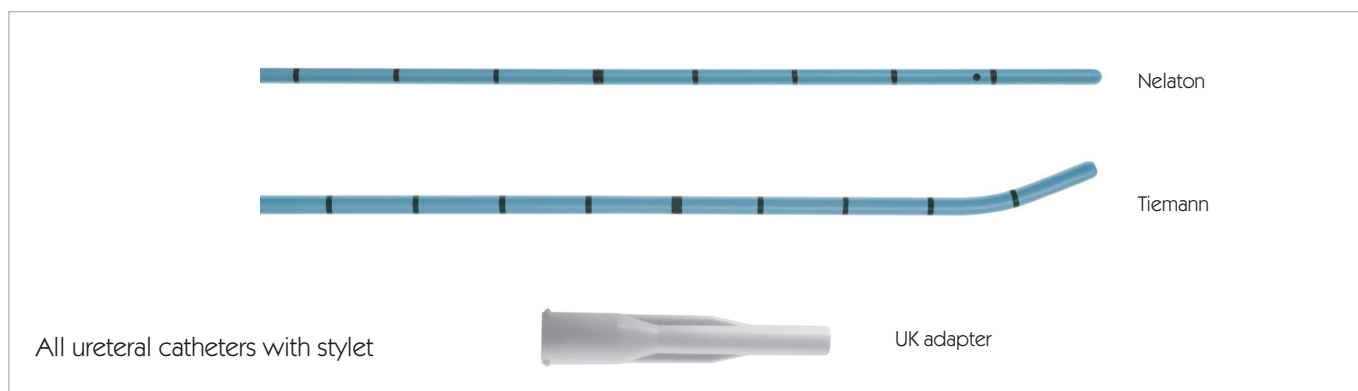

Nelaton tip

Order number Closed tip	Order number Open tip	Size (CH/FR)	Length (cm)	Maximum wire (inch)
UR-820370	UR-830370	3	70	0.025"
UR-820470	UR-830470	4	70	0.035"
UR-724770	UR-734770	4.7	70	0.035"
UR-820570	UR-830570	5	70	0.035"
UR-820670	UR-830670	6	70	0.038"
UR-820770	UR-830770	7	70	0.038"

Tiemann tip

Order number Closed tip	Order number Open tip	Size (CH/FR)	Length (cm)	Maximum wire (inch)
UR-840370	UR-850370	3	70	0.025"
UR-840470	UR-850470	4	70	0.035"
UR-744770	UR-754770	4.7	70	0.035"
UR-840570	UR-850570	5	70	0.035"
UR-840670	UR-850670	6	70	0.038"
UR-840770	UR-850770	7	70	0.038"

URETERAL CATHETER

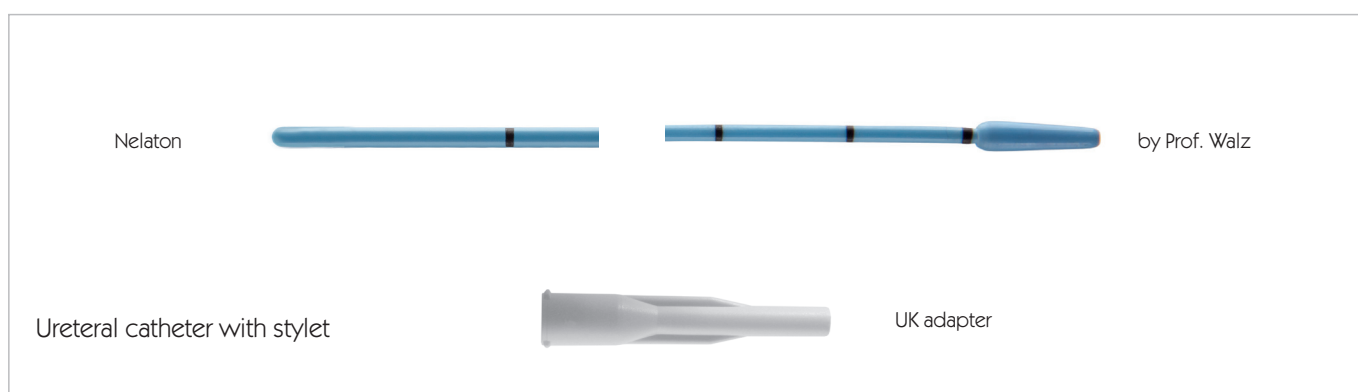

Ureteral catheter by Prof. Walz

- ◆ Two-sided tip configuration
- ◆ Open Nelaton tip
- ◆ Conically opening tip by Prof. Walz
- ◆ Ideal for retrograde imaging of upper urinary tract
- ◆ Optimal sealing of ureter orifice
- ◆ Top visibility in x-ray
- ◆ CM gradation for ideal placement
- ◆ Incl. UK adapter

Ureteral catheter by Prof. Walz				
Order number Closed tip	Size (CH/FR)	Tip by Prof. Walz (CH/ FR)	Length (cm)	Maximum wire (inch)
UR-630470	04	07	70	0.035"

Ureter Dilation Set for Ureteral Stenosis				
Order number Closed tip	Sizes in Set (CH/FR)	Length per catheter (cm)	Maximum wire (inch)	Extra
HB-5-10	5-10	70	0.035"	Incl. universal adapter and Tuohy Borst adapter

WWW.UROVISION.DE



UROVISION

Medi-Globe-Strasse 1-5
D-83101 Achenmühle,
Germany

☎ +49 (0) 80 32 / 973 - 400
📠 +49 (0) 80 32 / 973 - 411

SURGICAL
CATHETERS



SURGICAL CATHETERS

VISIODRAIN Balloon Catheters, Silicone	5.1
VISIOCATH Balloon Catheters, Silicone-coated	5.3
VISIOCATH Balloon Catheters, Latex	5.5
Tamponade Catheters	5.6
Double Balloon Catheters	5.7
NEOVISION Neobladder Catheters	5.8

VISIODRAIN BALLOON CATHETER

Postoperative Tamponade, 100 % silicone

DESCRIPTION

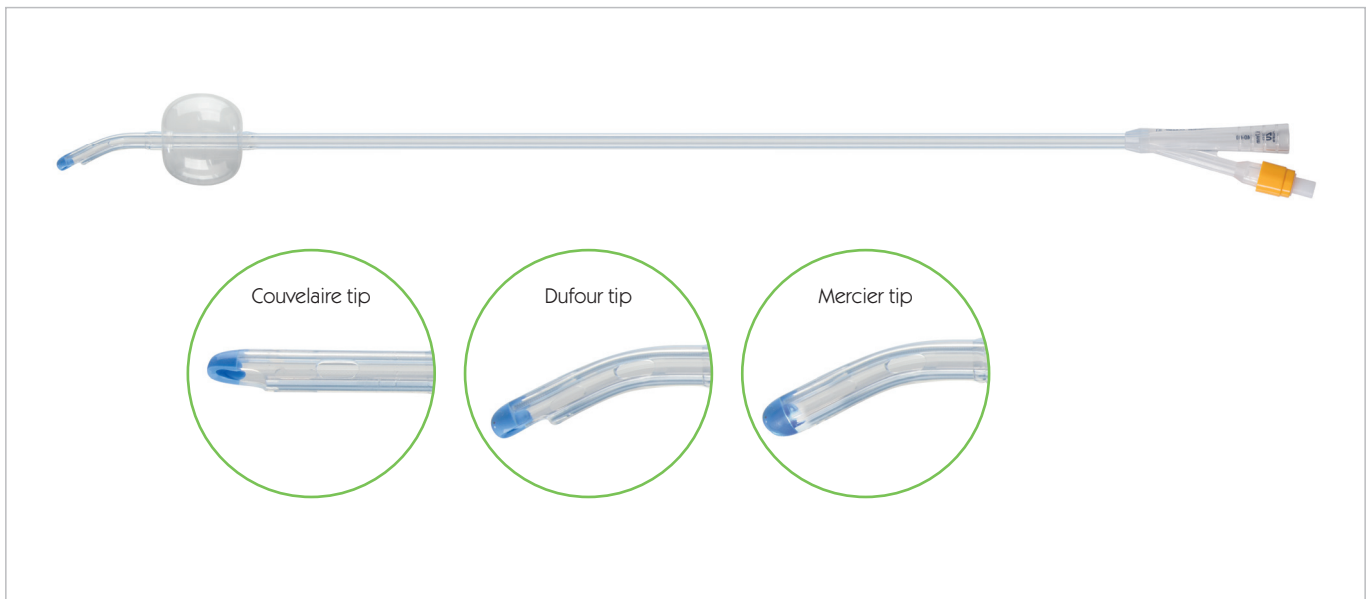

Balloon Catheter

- ◆ Silicone for optimal tissue compatibility
- ◆ Large balloon volume for safe compression and effective hemostasis
- ◆ Very high lavage and drainage performance levels
- ◆ 2-way catheter
- ◆ Variable balloon inflation

2-way Balloon Catheters with Couvelaire tip			
Order number	Size (CH/FR)	Length (cm)	Balloon capacity (ml)
KW-491830-50	18	42	30 - 50
KW-492040-60	20	42	40 - 60
KW-492250-70	22	42	50 - 70
KW-492460-80	24	42	60 - 80

2-way Balloon Catheters with Dufour tip			
Order number	Size (CH/FR)	Length (cm)	Balloon capacity (ml)
KW-481830-50	18	42	30 - 50
KW-482040-60	20	42	40 - 60
KW-482250-70	22	42	50 - 70
KW-482460-80	24	42	60 - 80

VISIODRAIN BALLOON CATHETER

Postoperative irrigation and Tamponade, 100 % silicone

2-way Balloon Catheters with Mercier tip			
Order number with open tip	Size (CH/FR)	Length (cm)	Balloon capacity (ml)
KW-521830-50-SL	18	42	30 - 50
KW-522040-60-SL	20	42	40 - 60
KW-522250-70-SL	22	42	50 - 70
KW-522460-80-SL	24	42	60 - 80

VISIODRAIN BALLOON CATHETER

Postoperative irrigation and Tamponade, 100 % silicone

DESCRIPTION

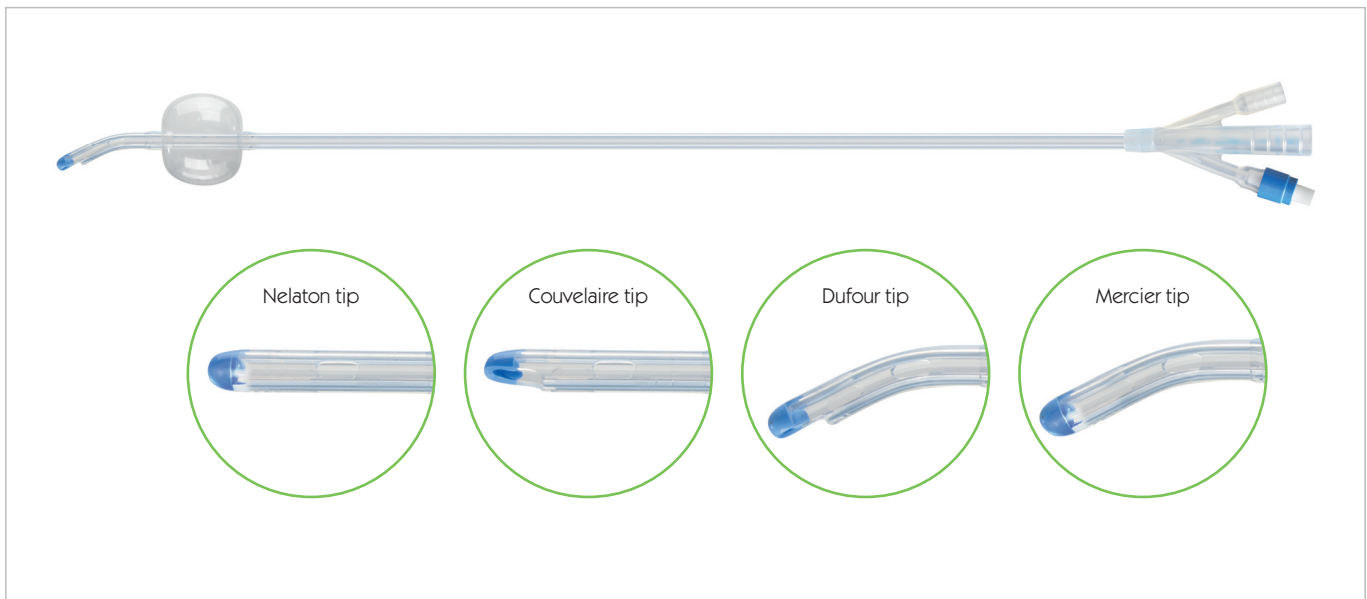

Balloon Catheter

- ◆ Silicone for optimal tissue compatibility
- ◆ Large balloon volume for safe compression and effective hemostasis
- ◆ Very high lavage and drainage performance levels
- ◆ 3-way catheter
- ◆ Variable balloon inflation

3-way Balloon Catheters with Nelaton tip				
Order number with closed tip	Order number with open tip	Size (CH/FR)	Length (cm)	Balloon capacity (ml)
KW-471630	KW-471630-SL	16	42	30
KW-471830	KW-471830-SL	18	42	30
KW-472030	KW-472030-SL	20	42	30
KW-472230	KW-472230-SL	22	42	30
KW-472430	KW-472430-SL	24	42	30

3-way Balloon Catheters with Couvelaire tip			
Order number	Size (CH/FR)	Length (cm)	Balloon capacity (ml)
KW-511830-50	18	42	30 - 50
KW-512040-60	20	42	40 - 60
KW-512250-70	22	42	50 - 70
KW-512460-80	24	42	60 - 80

VISIODRAIN BALLOON CATHETER

Postoperative Rinsing and Tamponade, 100 % silicone

3-way Balloon Catheters with Dufour tip			
Order number	Size (CH/FR)	Length (cm)	Balloon capacity (ml)
KW-501830-50	18	42	30 - 50
KW-502040-60	20	42	40 - 60
KW-502250-70	22	42	50 - 70
KW-502460-80	24	42	60 - 80

3-way Balloon Catheters with Mercier tip				
Order number with closed tip	Order number with open tip	Size (CH/FR)	Length (cm)	Balloon capacity (ml)
KW-531830-50	KW-531830-50-SL	18	40	30 - 50
KW-532040-60	KW-532040-60-SL	20	40	40 - 60
KW-532250-70	KW-532250-70-SL	22	40	50 - 70
KW-532460-80	KW-532460-80-SL	24	40	60 - 80

VISIOCATH BALLOON CATHETER

Postoperative tamponade, with latex core and solid silicone coating inside and outside

DESCRIPTION

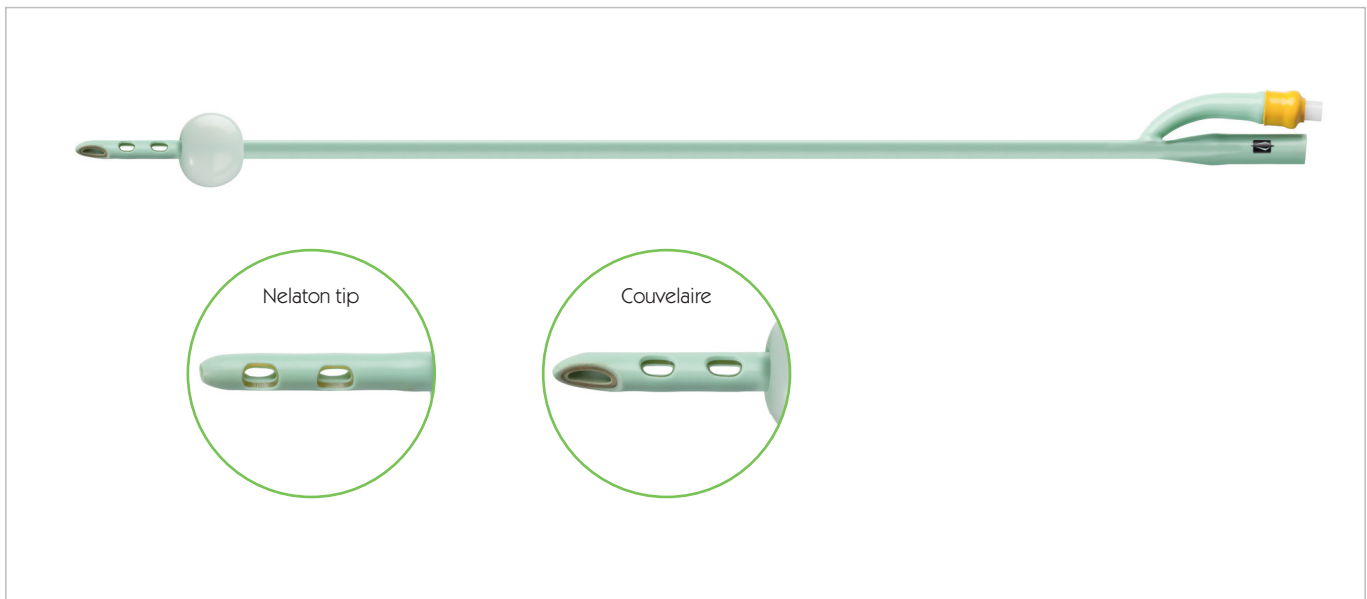

Balloon Catheter

- ◆ Silicone coating for optimal tissue compatibility
- ◆ High balloon stability, which largely eliminates the possibility of balloon ruptures and subsequent blockage
- ◆ Soft balloon catheter offers wearing comfort for patients
- ◆ The catheter is supported by a plastic spiral in the latex core to prevent collapse of the catheter lumen during bladder lavage
- ◆ 2-way catheter

2-way Balloon Catheters with Nelaton tip			
Order number	Size (CH/FR)	Length (cm)	Balloon capacity (ml)
KI-011880	18	40	30 - 50
KI-012080	20	40	40 - 60
KI-012280	22	40	50 - 70
KI-012480	24	40	60 - 80

2-way Balloon Catheters with Couvelaire tip			
Order number	Size (CH/FR)	Length (cm)	Balloon capacity (ml)
KI-021880	18	40	30 - 50
KI-022080	20	40	40 - 60
KI-022280	22	40	50 - 70

VISIOCATH BALLOON CATHETER

Postoperative lavage, with latex core and solid silicone coating inside and outside

DESCRIPTION

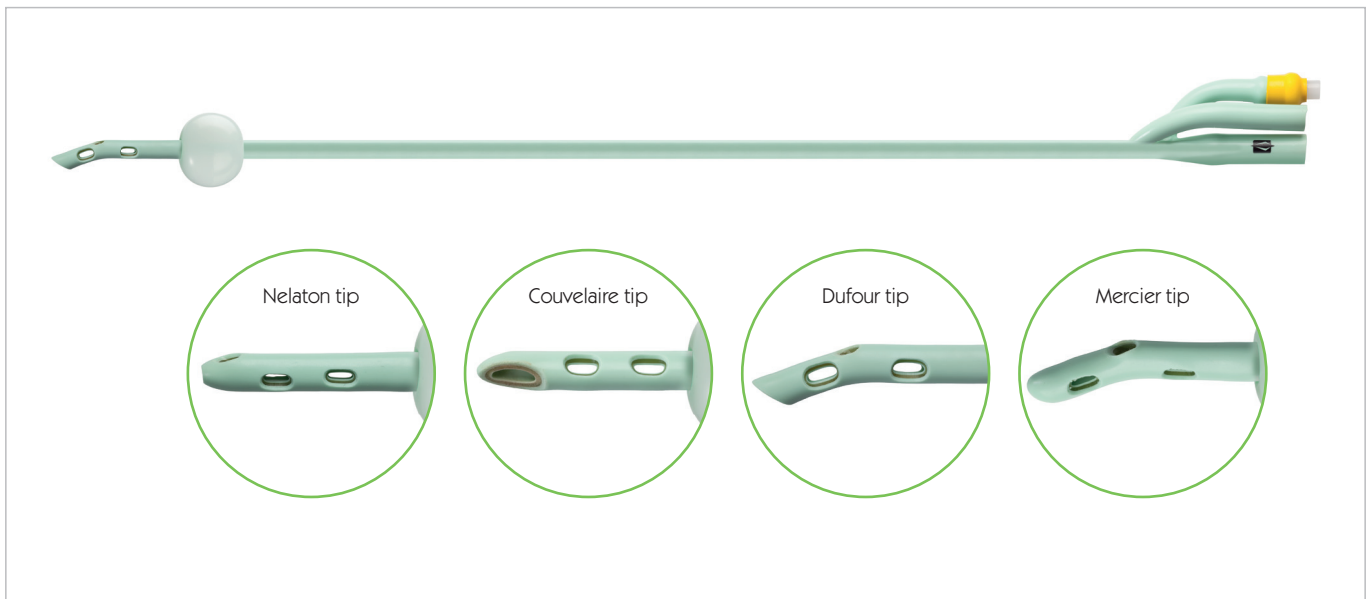

Balloon Catheter

- ◆ Silicone coating for optimal tissue compatibility
- ◆ High balloon stability, which largely eliminates the possibility of balloon ruptures and subsequent blockage
- ◆ Soft balloon catheter offers comfort of use for patients
- ◆ The catheter is supported by a plastic spiral in the latex core to prevent collapse of the catheter lumen during bladder lavage
- ◆ 3-way catheter

3-way Balloon Catheters with Nelaton Tip and End Hole			
Order number	Size (CH/FR)	Length (cm)	Balloon capacity (ml)
KI-061860	18	40	30 - 50
KI-062060	20	40	40 - 60
KI-062260	22	40	50 - 70
KI-062460	24	40	60 - 80

3-way Balloon Catheters with Couvelaire tip			
Order number	Size (CH/FR)	Length (cm)	Balloon capacity (ml)
KI-091880	18	40	30 - 50
KI-092080	20	40	40 - 60
KI-092280	22	40	50 - 70

SURGICAL CATHETERS

3-way Balloon Catheters with Dufour tip			
Order number	Size (CH/FR)	Length (cm)	Balloon capacity (ml)
KI-071880	18	40	30 - 50
KI-072080	20	40	40 - 60
KI-072280	22	40	50 - 70
KI-072480	24	40	60 - 80

3-way Balloon Catheters with Mercier tip			
Order number	Size (CH/FR)	Length (cm)	Balloon capacity (ml)
KI-081880	18	40	30 - 50
KI-082080	20	40	40 - 60
KI-082280	22	40	50 - 70
KI-082480	24	40	60 - 80

VISIOCATH BALLOON CATHETER

Tamponade, latex, siliconized

DESCRIPTION

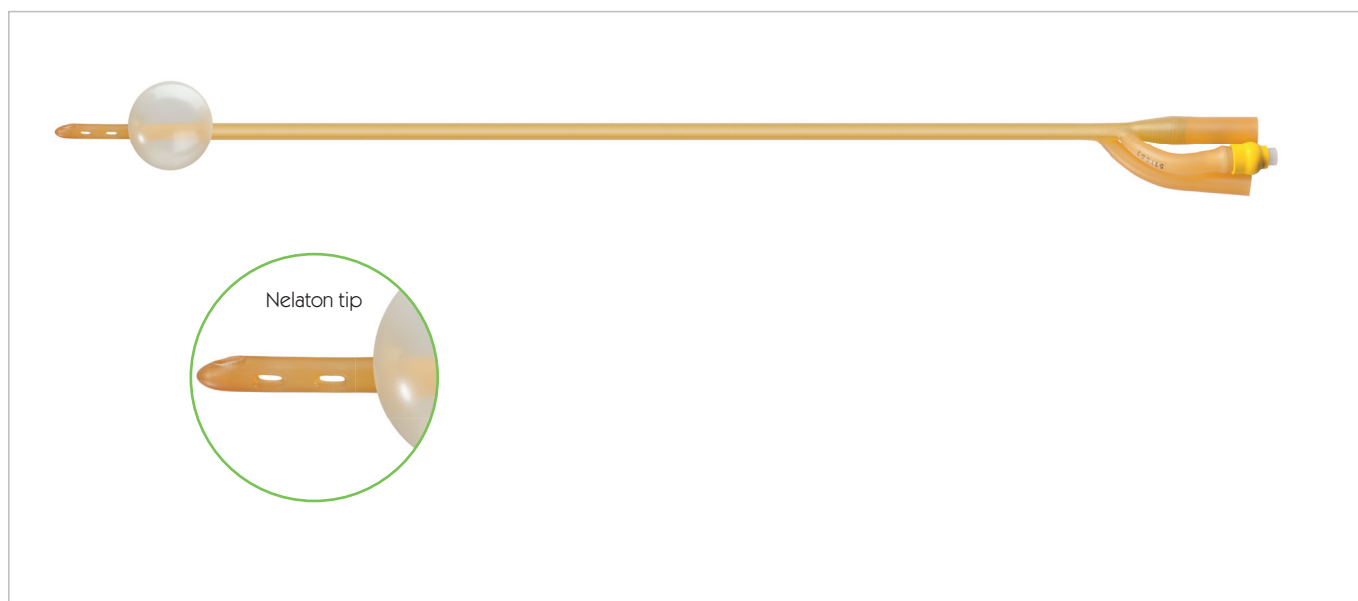

Balloon Catheter

- ◆ Siliconized latex catheter
- ◆ High balloon stability, which largely eliminates the possibility of balloon ruptures and subsequent blockage
- ◆ Soft balloon catheter offers wearing comfort for patients
- ◆ The catheter is supported by a plastic spiral in the latex core to prevent collapse of the catheter lumen during bladder lavage
- ◆ 2 or 3-way catheter

2-way Balloon Catheters with Nelaton tip

Order number	Size (CH/FR)	Length (cm)	Balloon capacity (ml)
KL-041850	18	40	30 - 60
KL-042050	20	40	30 - 60
KL-042250	22	40	30 - 60
KL-042450	24	40	30 - 60

3-way Balloon Catheters with Nelaton tip

Order number	Size (CH/FR)	Length (cm)	Balloon capacity (ml)
KL-061850	18	40	30 - 60
KL-062050	20	40	60 - 80
KL-062250	22	40	60 - 80
KL-062450	24	40	60 - 80

UROVISION TAMPONADE CATHETERS

With double balloon, with latex core and solid silicone coating inside and outside

DESCRIPTION

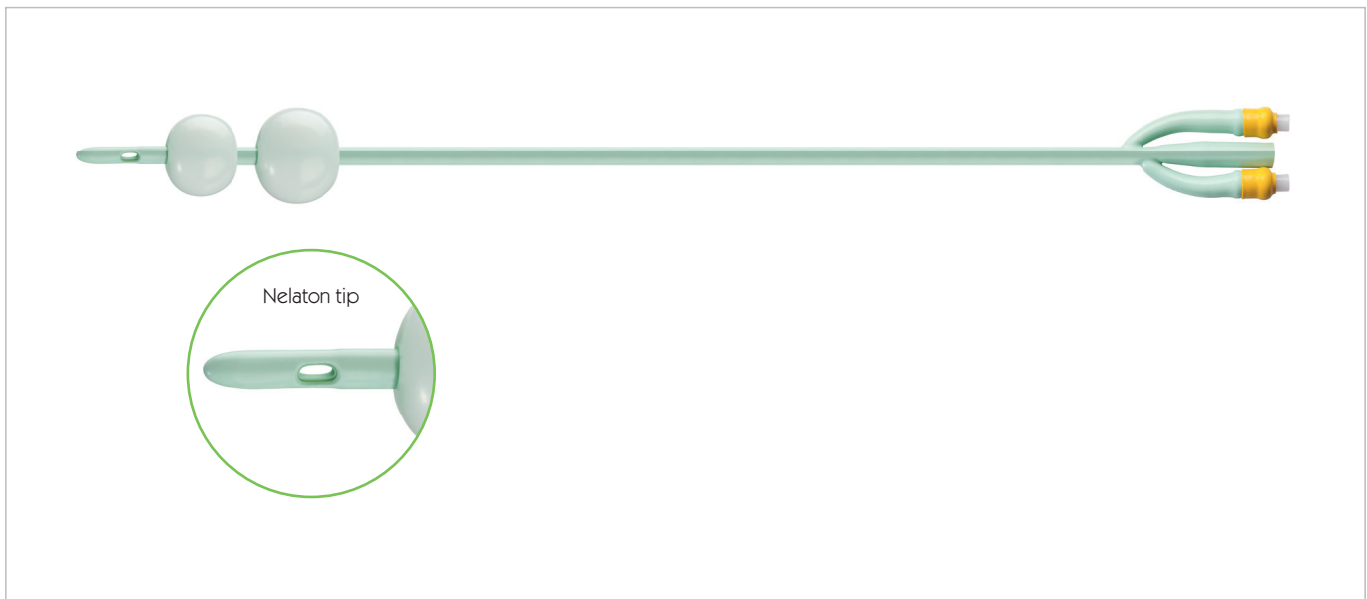

Tamponade catheter

- ◆ Silicone coating for optimal tissue compatibility
- ◆ High balloon stability, which largely eliminates the possibility of balloon ruptures and subsequent blockage
- ◆ Soft balloon catheter offers wearing comfort for patients

Order number	Size (CH/FR)	Length (cm)	Balloon capacity (ml)
KD-212240	22	40	1. Balloon 15 ml / 2. Balloon 30 ml

UROVISION DOUBLE BALLOON CATHETERS

For vesicourethral anastomosis, 100% silicone

DESCRIPTION

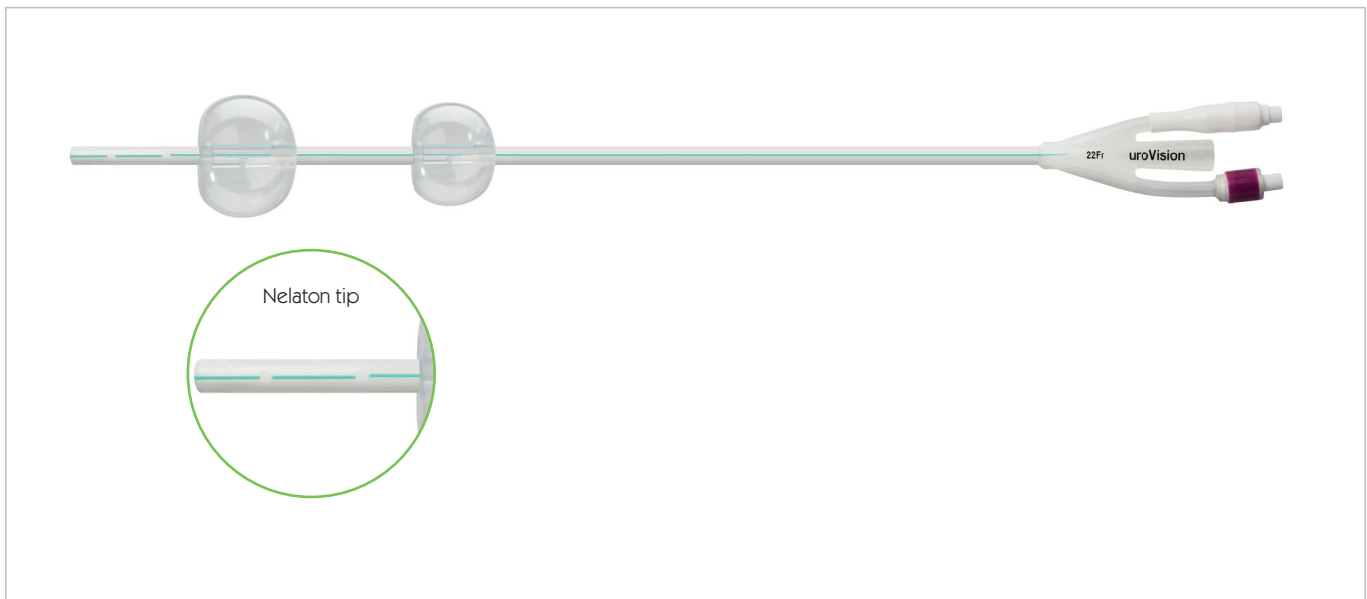

Double balloon catheter

- Using a double balloon catheter it is possible to slightly lift the perineum and to reveal the membranous urethra in order to prepare for anastomosis
- The balloon (5 ml) conforms ideally to the anatomical features of the bulbar urethra
- The proximal to 30 ml blockable balloon is suitable for reliable blockage in the bladder
- Balloon distance 5 cm

Order number	Size (CH/FR)	Length (cm)	Balloon capacity (ml)
KD-312240	22	40	5 / 30

NEOVISION NEOBLADDER CATHETERS

Bladder catheter for postoperative urinary diversion for neobladders following radical prostatectomy

DESCRIPTION

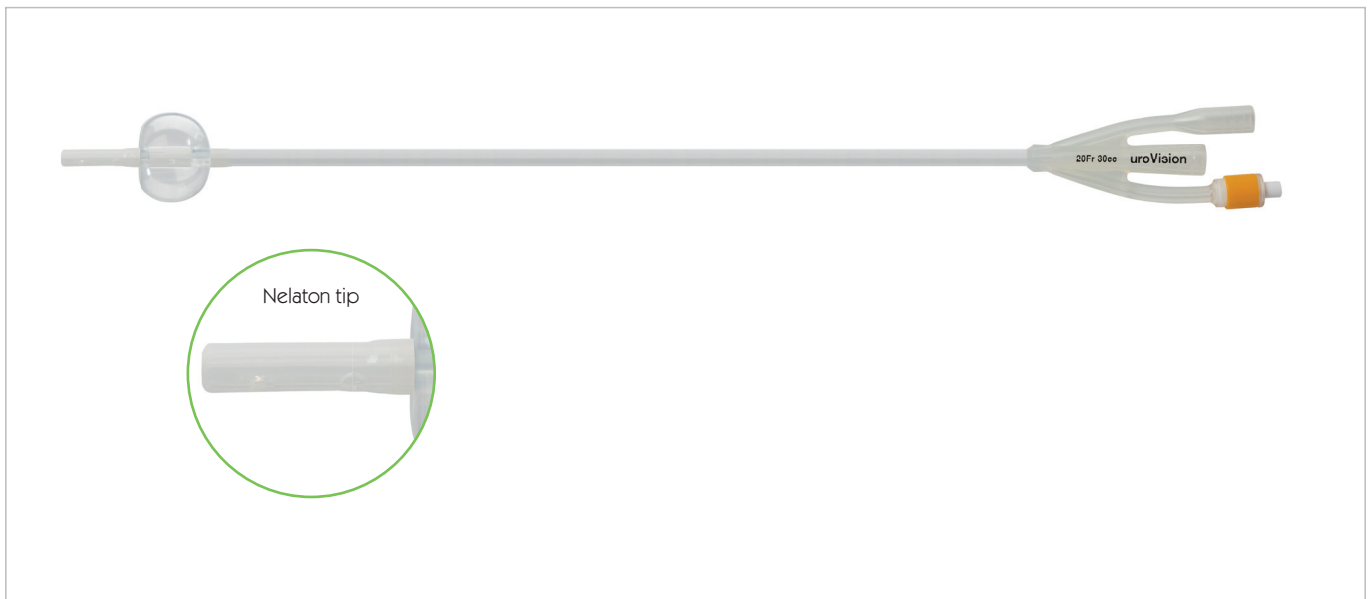

Neobladder Catheter

- ◆ Silicone for optimal tissue compatibility
- ◆ Very low encrustation levels
- ◆ Catheter can be exchanged through the open tip using a wire
- ◆ Catheter does not collapse during strong aspiration of coagulated mucus or blood

Order number	Size (CH/FR)	Length (cm)	Balloon capacity (ml)
NB-502040	20	40	30
NB-502240	22	40	30

WWW.UROVISION.DE



UROVISION

Medi-Globe-Strasse 1-5
D-83101 Achenmühle,
Germany

☎ +49 (0) 80 32 / 973 - 400
📠 +49 (0) 80 32 / 973 - 411

URODYNAMIC



URODYNAMIC

Urodynamic 2-way Measurement Catheters	6.1
Urodynamic 3-way Measurement Catheters	6.2
Rectal Pressure Measurement Catheter	6.3

URODYNAMIC 2-WAY MEASUREMENT CATHETERS

DESCRIPTION



2-way Measurement Catheters

- ◆ PVC-free and latex-free (material: polyurethane)
- ◆ Easy application due to good steering stability
- ◆ Color-coded attachments
- ◆ Radiopaque
- ◆ Optimal measurement results due to special catheter configuration
- ◆ Transurethral and suprapubic bladder pressure measurement

Nelaton tip		
Order number	Size (CH/FR)	Length (cm)
UR-325	07	25
UR-340	07	40
UR-425	09	25
UR-440	09	40

Tiemann tip		
Order number	Size (CH/FR)	Length (cm)
UR-530	07	40
UR-540	09	40

URODYNAMIC 2-WAY MEASUREMENT CATHETERS

With pigtail

DESCRIPTION

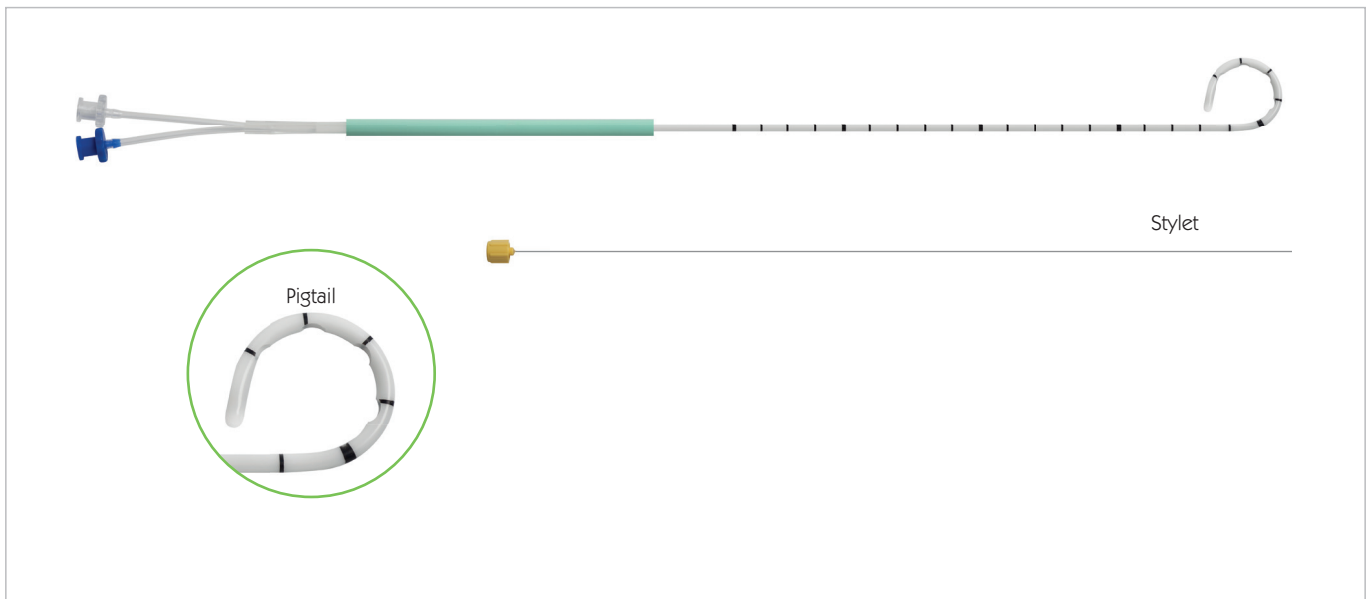

2-way Measurement Catheters

- ◆ PVC-free and latex-free (material: polyurethane)
- ◆ Easy application due to good steering stability
- ◆ Color-coded attachments
- ◆ Radiopaque
- ◆ Optimal measurement results due to special catheter configuration
- ◆ With stylet and stretching shell
- ◆ Transurethral and suprapubic bladder pressure measurement

With pigtail		
Order number	Size (CH/FR)	Length (cm)
UR-640	09	40

URODYNAMIC 3-WAY MEASUREMENT CATHETERS

For measurement of urethra pressure profile

DESCRIPTION



3-way Measurement Catheters

- ◆ PVC-free and latex-free (material: polyurethane)
- ◆ Easy insertion
- ◆ Color-coded attachments
- ◆ Radiopaque
- ◆ Optimal measurement results due to special catheter configuration

Nelaton tip		
Order number	Size (CH/FR)	Length (cm)
UR-140	08	40
UR-240	10	40

Tiemann tip		
Order number	Size (CH/FR)	Length (cm)
UR-150	08	40
UR-250	10	40

URODYNAMIC 3-WAY MEASUREMENT CATHETERS

For measurement of urethra pressure profile, with spacers

DESCRIPTION



3-way Measurement Catheters

- ◆ Optimal measurement results through the use of special spacers on the sensor
- ◆ PVC-free and latex-free (material: polyurethane)
- ◆ Easy insertion
- ◆ Color-coded attachments
- ◆ Radiopaque

Nelaton tip		
Order number	Size (CH/FR)	Length (cm)
UR-145	08	40
UR-245	10	40

Tiemann tip		
Order number	Size (CH/FR)	Length (cm)
UR-155	08	40
UR-255	10	40

SINGLE-WAY RECTAL PRESSURE MEASUREMENT CATHETERS

Measurement catheter for measuring rectal pressure, 100% silicone

DESCRIPTION

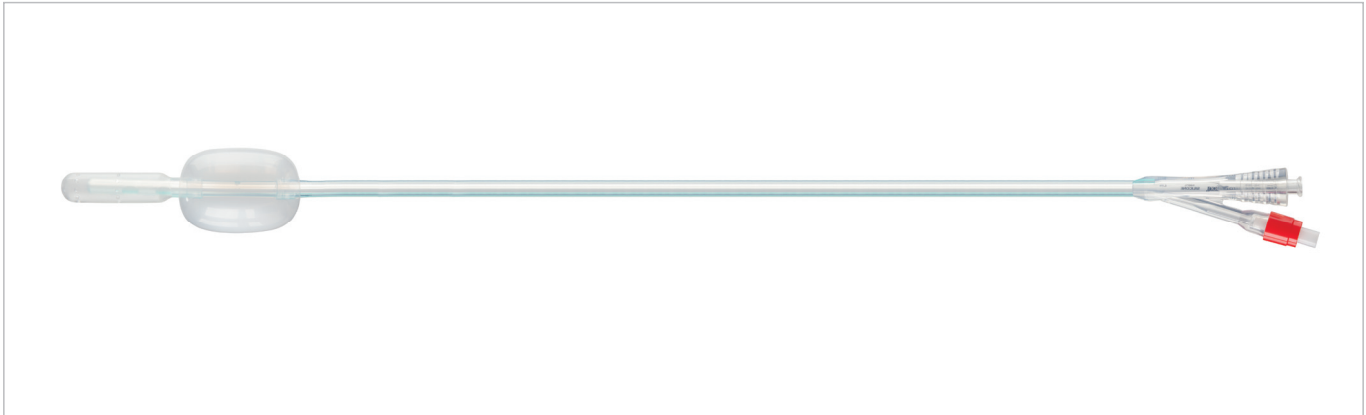

3-way Measurement Catheters

- ◆ Rectal catheter made of 100% silicone
- ◆ Fixing balloon prevents the catheter from slipping out of the rectum in case of compromised pelvic floor muscle tone
- ◆ The end of the catheter is protected from stool by a protective barrier. At the same time, perforations in the protective barrier guarantee a virtually direct connection to the pressure in the rectum once filled with water
- ◆ This ensures maximum precision of measurements
- ◆ The pressure measurement channel can be ventilated up to 100%

Order number	Size (CH/FR)	Length (cm)	Balloon capacity (ml)
UR-460	10	30	15
UR-470	18	30	30 - 45

WWW.UROVISION.DE



UROVISION

Medi-Globe-Strasse 1-5
D-83101 Achenmühle,
Germany

☎ +49 (0) 80 32 / 973 - 400
📠 +49 (0) 80 32 / 973 - 411

WIRES



GUIDE WIRES

Standard guide wires



Standard – PTFE coated stainless steel					
Order number	Size (inch)	Length (cm)	Tip	Stiffness Tip	Stiffness Shaft
ST-291518	0.018"	150	straight	standard	standard
ST-291525	0.025"	150	straight	standard	standard
ST-291028	0.028"	100	straight	standard	standard
ST-291528	0.028"	150	straight	standard	standard
ST-291532	0.032"	150	straight	standard	standard
ST-291035	0.035"	100	straight	standard	standard
ST-291235	0.035"	125	straight	standard	standard
ST-291535	0.035"	150	straight	standard	stiff
ST-298538	0.038"	85	straight	standard	standard
ST-291038	0.038"	100	straight	standard	standard
ST-291538	0.038"	150	straight	standard	standard
ST-291045	0.045"	100	straight	standard	standard

With movable core – PTFE coated stainless steel					
Order number	Size (inch)	Length (cm)	Tip	Stiffness Tip	Stiffness Shaft
ST-293501	0.035"	125	straight	standard	standard
ST-293502	0.035"	150	straight	standard	standard
ST-293550	0.035"	150	J-tip	standard	standard

Lunderquist – uncoated stainless steel					
Order number	Size (inch)	Length (cm)	Tip	Stiffness Tip	Stiffness Shaft
RN-741580	0.035"	80	J-tip (1.0 mm)	standard	standard

Lunderquist – PTFE coated stainless steel					
Order number	Size (inch)	Length (cm)	Tip	Stiffness Tip	Stiffness Shaft
RN-751580	0.035"	80	J-tip (1.5 mm)	standard	standard
RN-761680	0.035"	80	straight	standard	standard
RN-750380	0.035"	80	J-tip (3.0 mm)	standard	standard
RN-751500	0.035"	100	J-tip (1.5 mm)	standard	standard

WIRES

VISIOMULTI

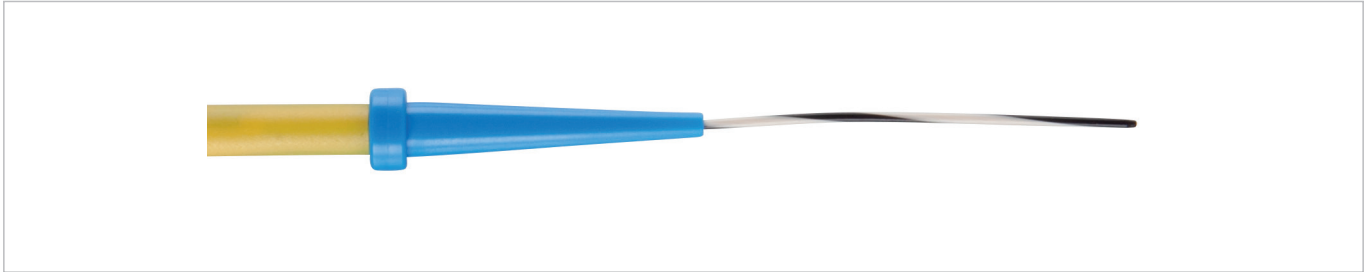

- ◆ Black-and-white coiled
- ◆ Optimal control over advancement
- ◆ Nitinol core increases resistance to kinks
- ◆ PTFE coating enables fast and easy advancement and has optimal gliding properties

Order number	Size (inch)	Length (cm)	Tip	Stiffness Tip	Stiffness Shaft
ST-28150	0.028"	150	straight	flexible	stiff
ST-32150	0.032"	150	straight	flexible	stiff
ST-35150	0.035"	150	straight	flexible	stiff

VISIOMULTI DUO

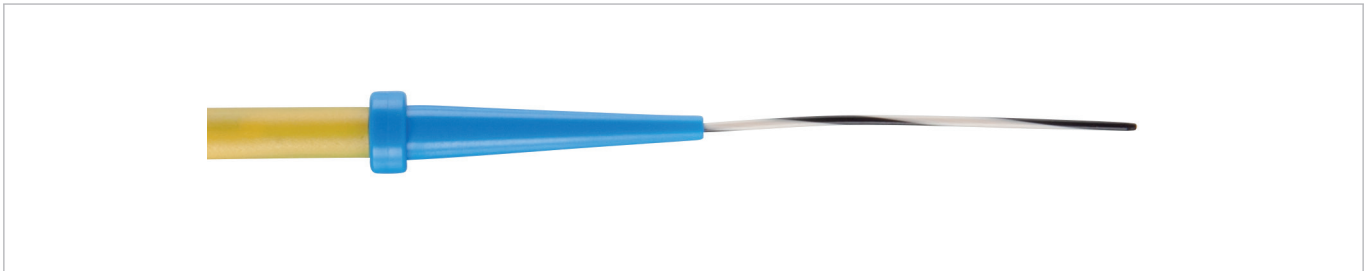

- ◆ PTFE coated Nitinol guide wire with flexibility at both ends
- ◆ Optimally suited for use with flexible ureter endoscopes

Order number	Size (inch)	Length (cm)	Tip	Stiffness Tip	Stiffness Shaft
ST-36150	0.035"	150	straight	flexible	stiff

WIRES

VISIOLIX

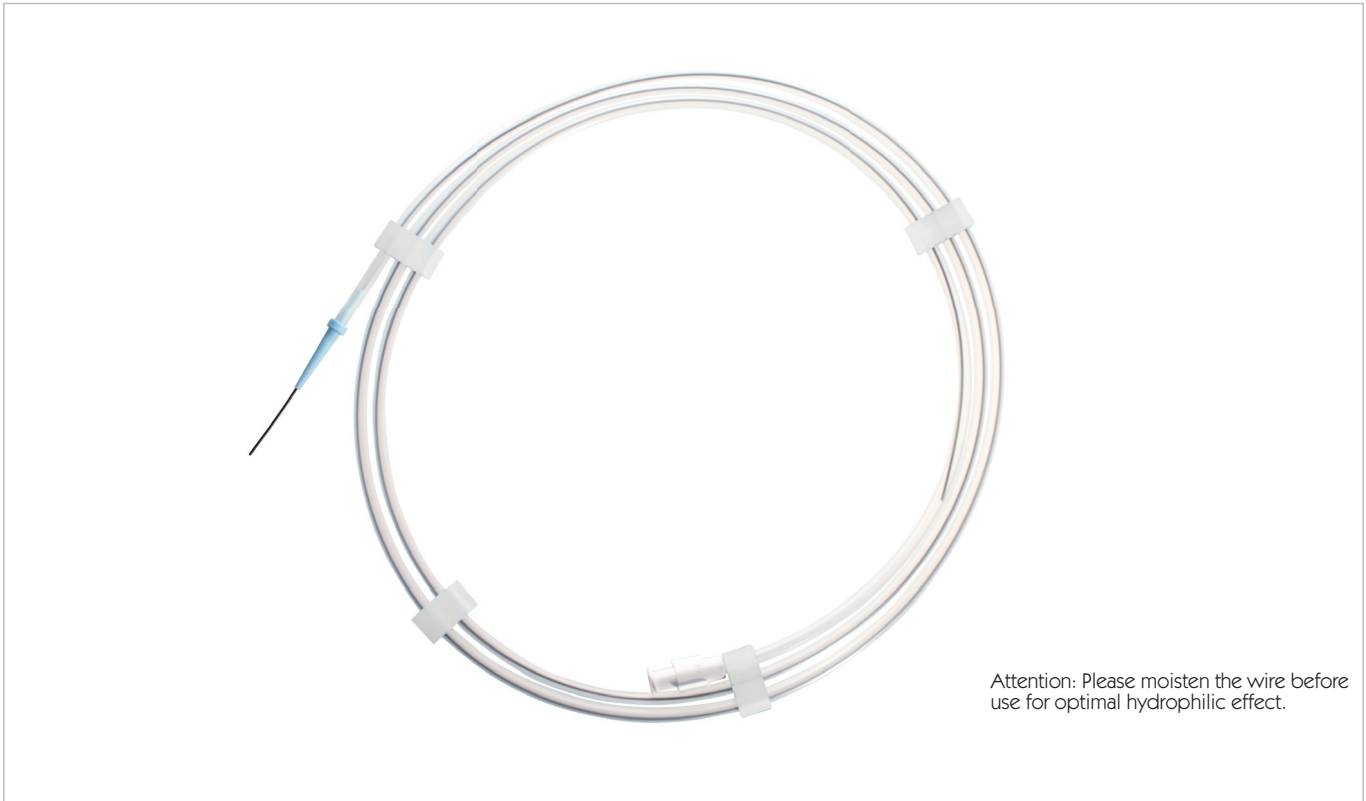

- ◆ Hydrophilic coating
- ◆ Super-elastic and stable against kinking
- ◆ Nitinol core

Order number	Size (inch)	Length (cm)	Tip	Stiffness Tip	Stiffness Shaft
VLG-67150	0.025"	150	straight	standard	standard
VLG-68150	0.032"	150	straight	standard	standard
VLG-69150	0.035"	150	straight	standard	standard
VLA-71150	0.025"	150	bent	standard	standard
VLA-72150	0.032"	150	bent	standard	standard
VLA-73150	0.035"	150	bent	standard	standard
VLS-62150	0.025"	150	straight	standard	stiff
VLS-63150	0.035"	150	straight	standard	stiff
VLS-64150	0.038"	150	straight	standard	stiff
VLA-66150-H	0.038"	150	bent	standard	stiff

ACCESSORIES



ACCESSORIES

Split cannulas	8.1
Puncture needles	8.2
Dilators	8.3
Adapters	8.4
Catheter Vent and Stoppers	8.5
Urethra Olive and Injections	8.6

SPLIT CANNULAS

For suprapubic puncture of the bladder

DESCRIPTION



Order number	For catheter (CH/FR, length)	Length (cm)	Inside diameter (mm)	Outside diameter (mm)
SV-391008	08, 35 cm	8	3.15	3.6
SV-391012	08, 40 cm	12	3.15	3.6
SV-391408	10 +12, 35 cm	8	4.2	4.6
SV-391412	10 +12, 40 cm	12	4.2	4.6
SV-391512	14, 40 cm	12	5.2	5.6

NEPHROSTOMY PUNCTURE NEEDLES

2-part needle

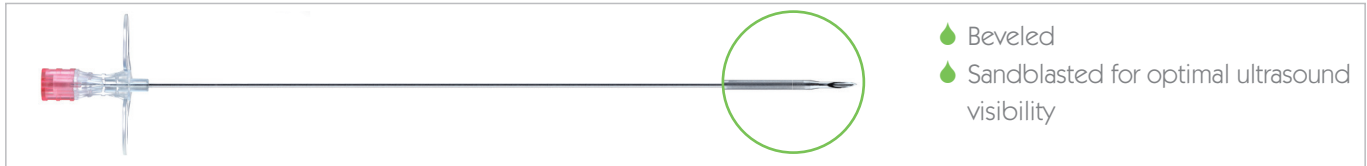

- ◆ Beveled
- ◆ Sandblasted for optimal ultrasound visibility

Order number	Size (G)	Length (cm)	Maximum guide wire
RN-611820	18	19.5	0.035"

2-part needle

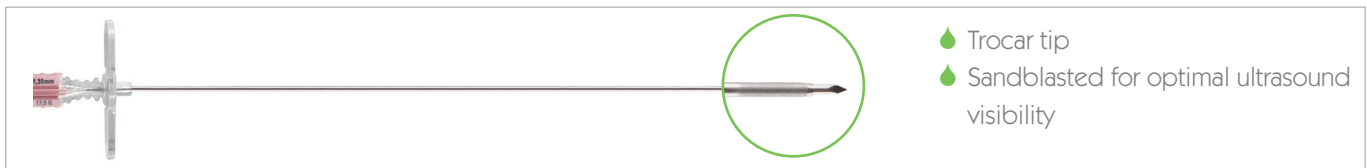

- ◆ Trocar tip
- ◆ Sandblasted for optimal ultrasound visibility

Order number	Size (G)	Length (cm)	Maximum guide wire
RN-621820	18	19.5	0.035"
RN-611835	18	35	0.035"

2-part Chiba needle

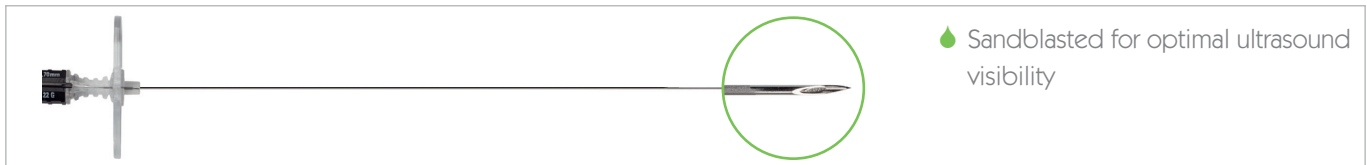

- ◆ Sandblasted for optimal ultrasound visibility

Order number	Size (G)	Length (cm)	Maximum guide wire
RN-632220	22	20	0.018"
RN-632228	22	28	0.018"

3-piece needle

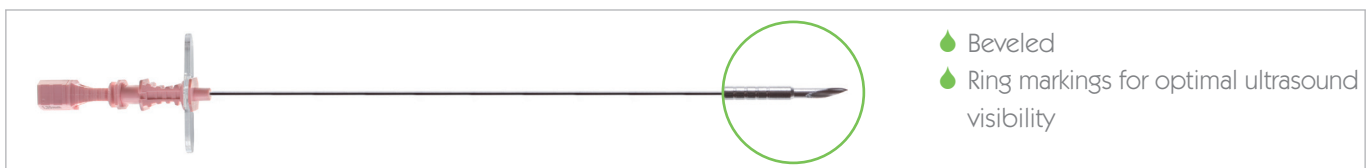

- ◆ Beveled
- ◆ Ring markings for optimal ultrasound visibility

Order number	Size (G)	Length (cm)	Maximum guide wire
RN-601820	18	20	0.035"

RENOVISION DILATORS



Dilators / single			
Order number	Size (CH/FR)	Length (cm)	Maximum guide wire
RN-770518	05	18	0.035
RN-770618	06	18	0.038"
RN-770718	07	18	0.038"
RN-770818	08	18	0.038"
RN-770918	09	18	0.038"
RN-771018	10	18	0.038"
RN-771218	12	18	0.038"
RN-771418	14	18	0.038"
RN-771618	16	18	0.038"
RN-771818	18	18	0.038"
RN-772018	20	18	0.038"
RN-772218	22	18	0.038"

Dilator with split shaft / single			
Order number	Size (CH/FR)	Length (cm)	Maximum guide wire
RN-780600	06	18	0.038"
RN-780700	07	18	0.038"
RN-780800	08	18	0.038"
RN-780900	09	18	0.038"
RN-781000	10	18	0.038"
RN-781200	12	18	0.038"
RN-781400	14	18	0.038"
RN-781600	16	18	0.038"
RN-781800	18	18	0.038"
RN-782000	20	18	0.038"
RN-782200	22	18	0.038"
RN-782400	24	18	0.038"

Dilator Set			
Order number	Size with split shaft* (CH/FR)	Length (cm)	Maximum guide wire
RN-790816	08/10/12/14/16	18	0.038"
RN-791600	08/10/12/14/16*	18	0.038"

ADAPTER

UK injection adapter



Order number	Size (G)
AD-270	03
AD-280	04
AD-210	4.7
AD-211	05
AD-212	06
AD-215	07
AD-218	08/09/10

Needle adapter with funnel



Order number	Size (G)
AD-380	04
AD-310	4.7
AD-311	05
AD-312	06
AD-315	07
AD-318	08/09

Tuohy Borst Adapter



Order number	Luer Lock	Suitable for size (CH/FR)
AD-112	Male	06-12
AD-113	Female	06-12

Tuohy Borst Adapter



AD-116

Order number	Luer Lock	Suitable for size (CH/FR)
AD-116	With silicone tube (7 cm) and male Luer lock	06-12

Universal adapter with step taper and injection apparatus



Order number
AD-103-2

Y connector with contrast medium imaging

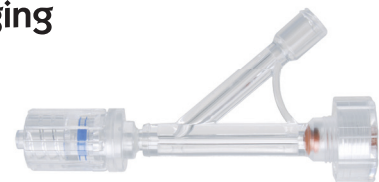

Order number
RN-550

"ONE SIZE FITS ALL" UNIVERSAL ADAPTER

- ◆ Consists of a Luer lock connector and a silicone tube
- ◆ The adapter enables connection of all common urine drainage bag systems with a tapered attachment
- ◆ Especially well suited for connection between Luer lock instruments (nephrostomy and cystostomy)
- ◆ Easy, universal connection possible for patient and medical professional

Universal adapter

- ◆ With silicone tube connection, Luer lock male and female
- ◆ With step taper, Luer lock male and female



Universal adapter with silicone tube connection, Luer lock male		
Order number	Length of connector (cm)	Material property
AD-1005	5	PVC-free
AD-1010	10	PVC-free
AD-1020	20	PVC-free



Universal adapter with silicone tube connection, Luer lock female		
Order number	Length of connector (cm)	Material property
AD-2005	5	PVC-free



ADAPTER

Universal adapter with step taper, Luer lock male		
Order number	Length of connector (cm)	Material property
AD-100	15	PVC-free
AD-101	-	PVC-free, polyurethane



Universal adapter with step taper, Luer lock female		
Order number	Length of connector (cm)	Material property
AD-103	-	PVC-free



Connection adapter

- ◆ With step taper and silicone tube connection

Connection adapter with step taper and silicone tube connection		
Order number	Length of connector (cm)	Material property
AD-220	25	PVC-free



CATHETER VALVES & CATHETER STOPPERS

Catheter valves

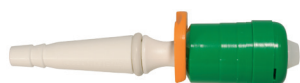

KV-100 EH

- ◆ Easy, one-handed use
- ◆ Increase in mobility and quality of life
- ◆ Minimization of bladder shrinkage through bladder training
- ◆ Cost reduction by elimination of leg bag in mobile patients
- ◆ Over-the-counter aid

Order number
KV-100 EH

Commercial products distributed by UROVISION.



089805

- ◆ Easy, one-handed use
- ◆ Ergonomic shape of pushing piece is suitable for left and right handed people
- ◆ Non-slip surface
- ◆ Increase in mobility and quality of life
- ◆ Minimization of bladder shrinkage through bladder training
- ◆ Cost reduction by elimination of leg bag in mobile patients
- ◆ Over-the-counter aid

Order number
089805

Commercial products distributed by UROVISION.



21104201

- ◆ Easy use
- ◆ Night setting for continuous drainage with the option of attaching a night bag
- ◆ Includes silicone tube for attachment to a urine drainage bag
- ◆ Increase in mobility and quality of life
- ◆ Minimization of bladder shrinkage through bladder training
- ◆ Cost reduction by elimination of leg bag in mobile patients
- ◆ Over-the-counter aid

Order number
21104201

Commercial products distributed by UROVISION.

Catheter stoppers



070370000

- ◆ Suitable for all balloon catheter funnel attachments

Order number
070370000

Commercial products distributed by UROVISION.

URETHRA OLIVE & INJECTIONS

Urethra olive

Order number
HO-002



Commercial products distributed by UROVISION.

Block injection

- ◆ Luer injection with a mixture of distilled water and glycerin (10%)

Order number	Capacity (ml)
SP-2100-10	10



Wound and bladder injection

- ◆ For wound and bladder lavage, 120 ml

Order number	Capacity (ml)
SP-22100	120



Commercial products distributed by UROVISION.

WWW.UROVISION.DE



UROVISION

Medi-Globe-Strasse 1-5
D-83101 Achenmühle,
Germany

☎ +49 (0) 80 32 / 973 - 400
📠 +49 (0) 80 32 / 973 - 411

BIOPSY

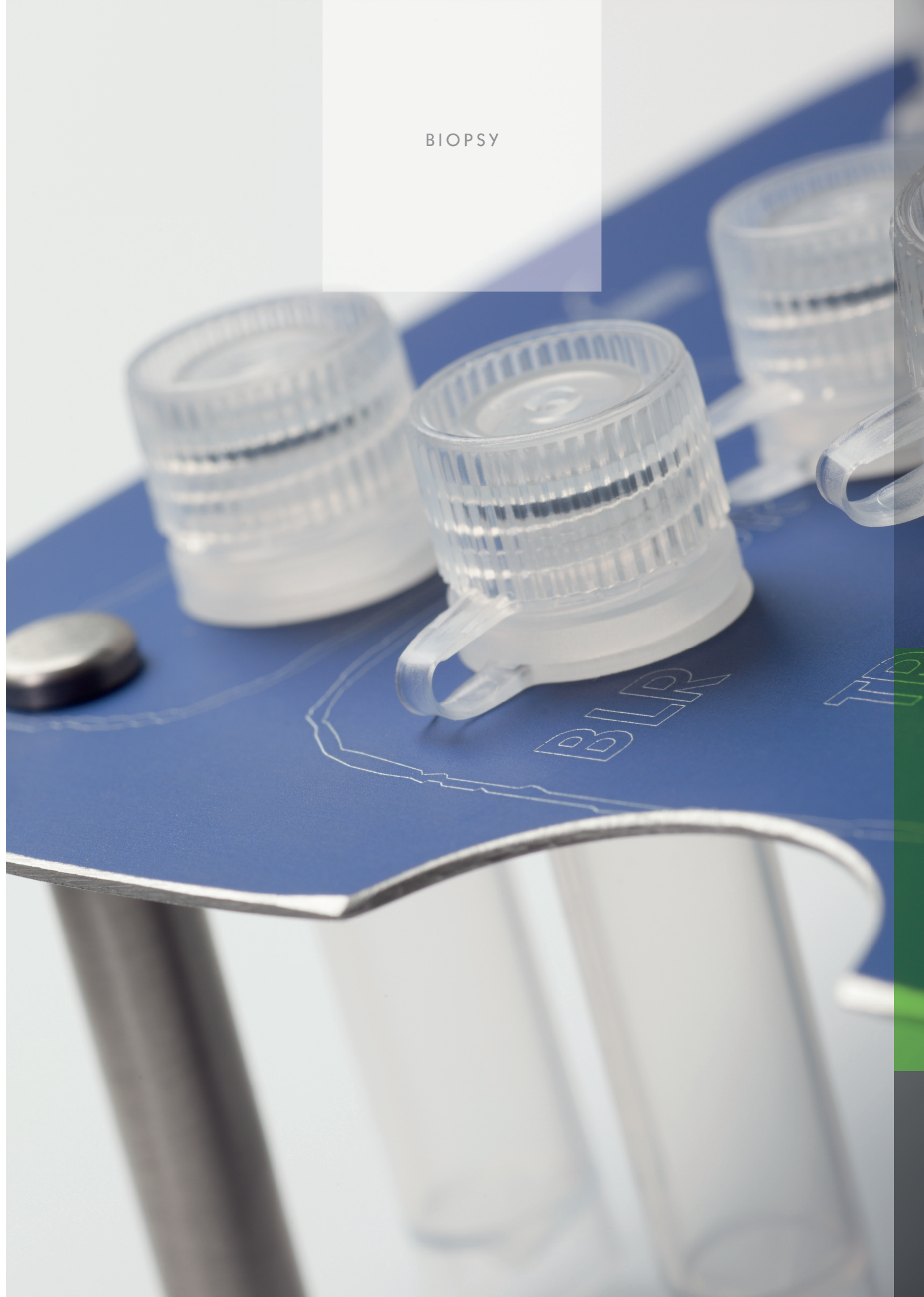

BIOPSY

Biopsy cannulas suitable for Pro-Mag™	9.1
Biopsy cannulas suitable for Bard® Magnum®	9.2
Single biopsy	9.3
Chiba needle	9.4

BIOPSY CANNULAS

For the automated removal of biopsied material

DNG-1010 suitable for e.g. PRO-MAG™ 2.2

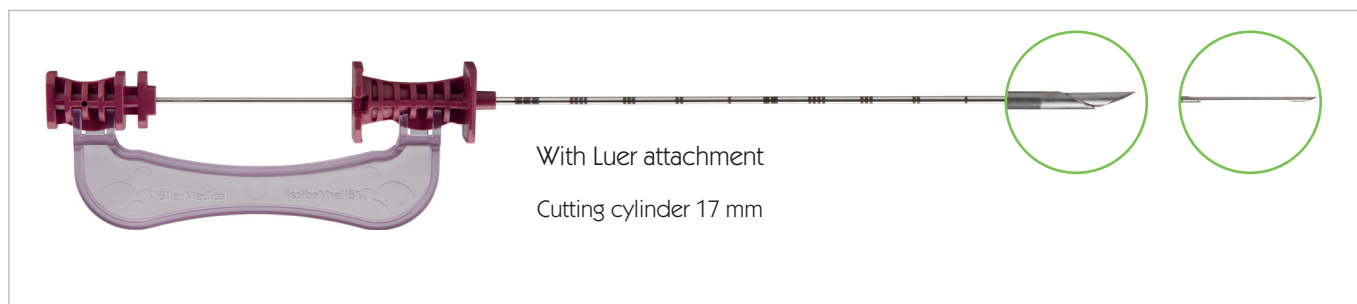

DNG-1020 suitable for e.g. PRO-MAG™ Ultra

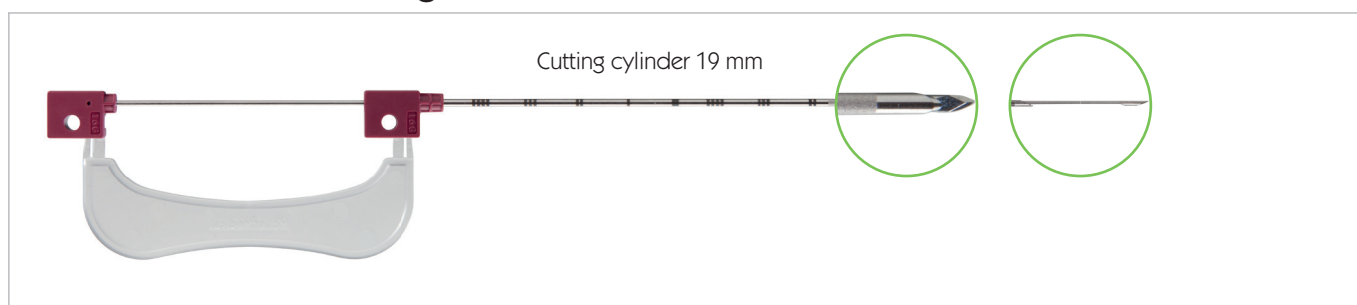

- ◆ First-class beveling process for high-quality histological findings
- ◆ Centimeter gradation for exact determination of incision depth
- ◆ Echoic tip for clear visibility in ultrasound
- ◆ Size easily identified based on color marking

Order number	Size (G)	Length (cm)	Suitable Coaxial needle
DNG-1010-14-0100	14	10	COX-1010-14-0046
DNG-1010-14-0120	14	12	
DNG-1010-14-0160	14	16	COX-1010-14-0106
DNG-1010-14-0200	14	20	
DNG-1010-16-0100	16	10	COX-1010-16-0046
DNG-1010-16-0160	16	16	COX-1010-16-0106
DNG-1010-16-0200	16	20	
DNG-1010-16-0250	16	25	
DNG-1010-18-0100	18	10	COX-1010-18-0049
DNG-1010-18-0160	18	16	COX-1010-18-0106
DNG-1010-18-0200	18	20	COX-1010-18-0146
DNG-1010-18-0250	18	25	
DNG-1010-18-0300	18	30	
DNG-1010-20-0100	20	10	COX-1010-20-0049
DNG-1010-20-0160	20	16	COX-1010-20-0109
DNG-1010-20-0200	20	20	

Order number	Size (G)	Length (cm)	Suitable Coaxial needle
DNG-1020-14-0100	14	10	COX-1020-14-0046
DNG-1020-14-0120	14	12	
DNG-1020-14-0160	14	16	COX-1020-14-0106
DNG-1020-14-0200	14	20	
DNG-1020-16-0100	16	10	COX-1020-16-0046
DNG-1020-16-0160	16	16	COX-1020-16-0106
DNG-1020-16-0200	16	20	
DNG-1020-16-0250	16	25	
DNG-1020-18-0100	18	10	COX-1020-18-0046
DNG-1020-18-0160	18	16	COX-1020-18-0106
DNG-1020-18-0200	18	20	COX-1020-18-0146
DNG-1020-18-0250	18	25	
DNG-1020-18-0300	18	30	
DNG-1020-20-0100	20	10	COX-1020-20-0049
DNG-1020-20-0160	20	16	COX-1020-20-0109
DNG-1020-20-0200	20	20	

BIOPSY CANNULAS

For the automated removal of biopsied material

DNG-1040 suitable for e.g. Bard® Magnum®

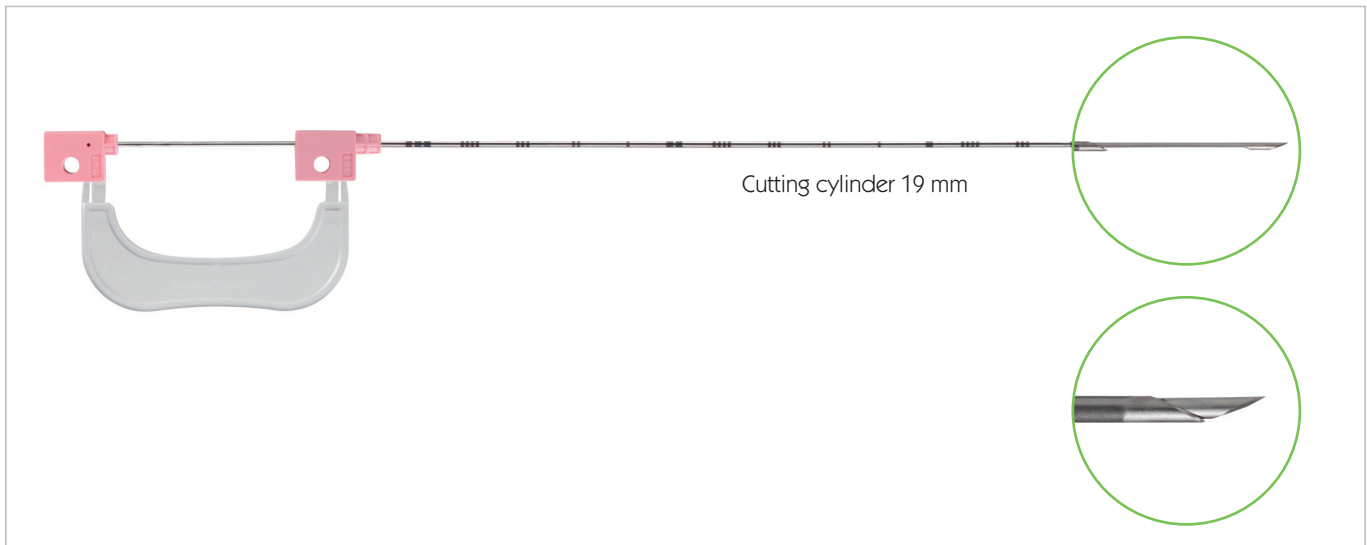

- ◆ First-class beveling process for high-quality histological findings
- ◆ Centimeter gradation for exact determination of incision depth
- ◆ Echoic tip for clear visibility in ultrasound
- ◆ Size easily identified based on color marking

Order number	Size (G)	Length (cm)	Suitable Coaxial needle
DNG-1040-14-0100	14	10	COX-1040-14-0043
DNG-1040-14-0130	14	13	
DNG-1040-14-0160	14	16	COX-1040-14-0103
DNG-1040-14-0200	14	20	
DNG-1040-16-0100	16	10	COX-1040-16-0043
DNG-1040-16-0130	16	13	
DNG-1040-16-0160	16	16	COX-1040-16-0103
DNG-1040-16-0200	16	20	
DNG-1040-18-0100	18	10	COX-1040-18-0043
DNG-1040-18-0130	18	13	
DNG-1040-18-0160	18	16	COX-1040-18-0103
DNG-1040-18-0200	18	20	COX-1040-18-0143
DNG-1040-18-0250	18	25	
DNG-1040-18-0300	18	30	
DNG-1040-20-0100	20	10	COX-1040-20-0046
DNG-1040-20-0130	20	13	
DNG-1040-20-0160	20	16	COX-1040-20-0106
DNG-1040-20-0200	20	20	

Commercial products distributed by UROVISION.

SINGLE BIOPSY

For the automated removal of biopsied material

ABG-2020

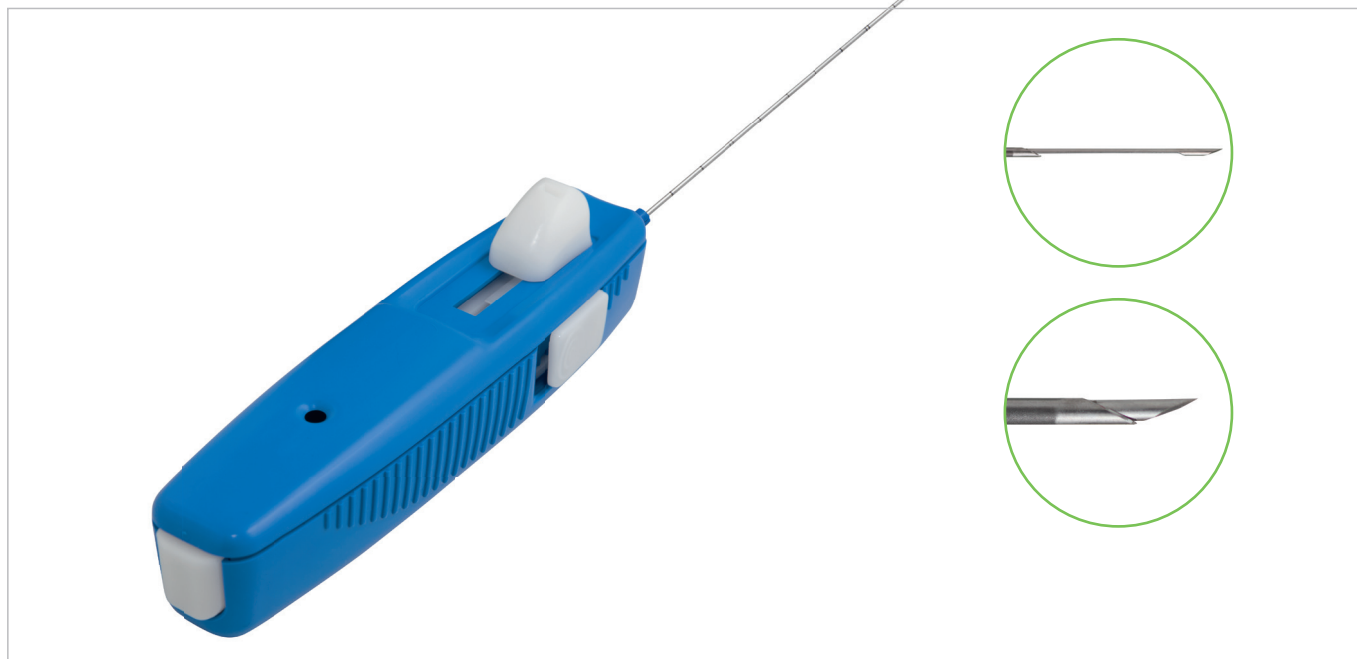

- ◆ First-class beveling process for high-quality histological findings
- ◆ Centimeter gradation for exact determination of incision depth
- ◆ Echoic tip for clear visibility in ultrasound
- ◆ Single-hand use with optional side or back triggering
- ◆ Applicable both semiautomated or fully automated
- ◆ Cutting cylinder 19 mm

Order number	Size (G)	Length (cm)	Suitable coaxial needle
ABG-2020-14-0100	14	10	COX-2000-14-0051
ABG-2020-14-0150	14	15	COX-2000-14-0101
ABG-2020-14-0200	14	20	COX-2000-14-0151
ABG-2020-16-0100	16	10	COX-2000-16-0051
ABG-2020-16-0150	16	15	COX-2000-16-0101
ABG-2020-16-0200	16	20	COX-2000-16-0151
ABG-2020-18-0100	18	10	COX-2000-18-0051
ABG-2020-18-0150	18	15	COX-2000-18-0101
ABG-2020-18-0200	18	20	COX-2000-18-0151
ABG-2020-18-0250	18	25	COX-2000-18-0201
ABG-2020-20-0100	20	10	COX-2000-20-0051
ABG-2020-20-0150	20	15	COX-2000-20-0101
ABG-2020-20-0200	20	20	COX-2000-20-0151

Commercial products distributed by UROVISION.

SINGLE BIOPSY

For semiautomated removal of biopsied material from the kidney

SBG-2010

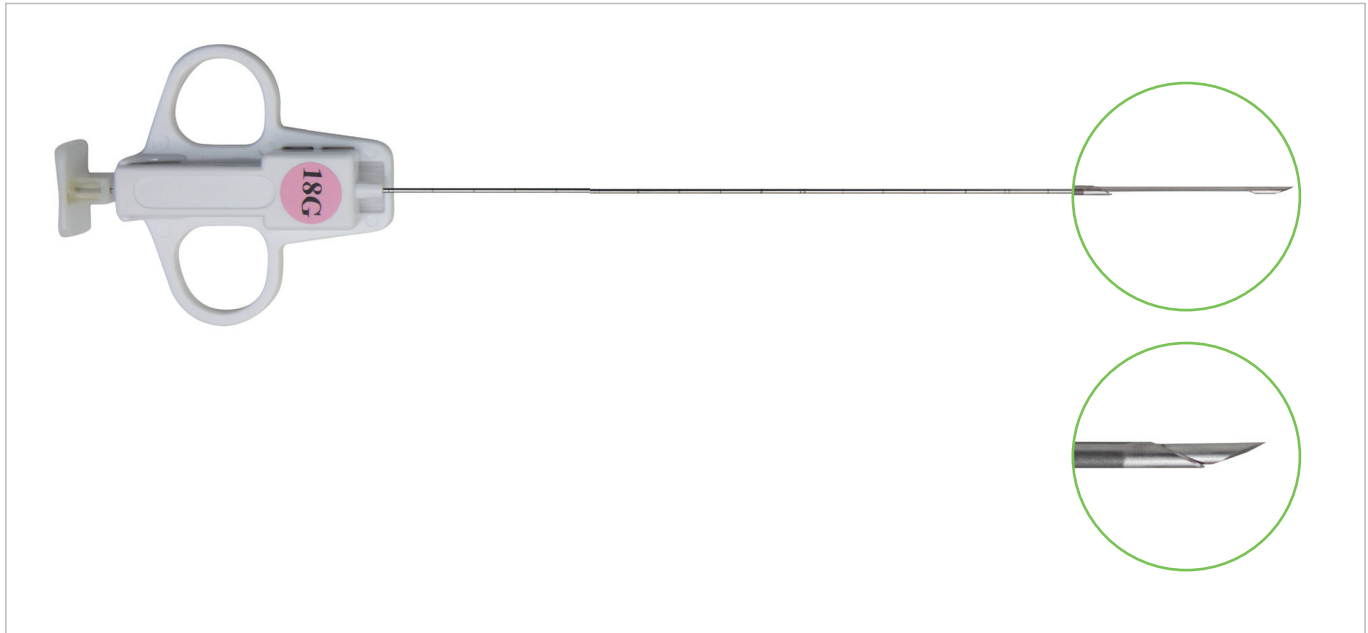

- ◆ First-class beveling process for high-quality histological findings
- ◆ Centimeter gradation for exact determination of incision depth
- ◆ Echoic tip for clear visibility in ultrasound
- ◆ Cutting cylinder can be set to 10 mm or 20 mm

Order number	Size (G)	Length (cm)	Suitable coaxial needle
SBG-2010-14-0100	14	10	COX-2000-14-0051
SBG-2010-14-0150	14	15	COX-2000-14-0101
SBG-2010-14-0200	14	20	COX-2000-14-0151
SBG-2010-16-0100	16	10	COX-2000-16-0051
SBG-2010-16-0150	16	15	COX-2000-16-0101
SBG-2010-16-0200	16	20	COX-2000-16-0151
SBG-2010-18-0100	18	10	COX-2000-18-0051
SBG-2010-18-0150	18	15	COX-2000-18-0101
SBG-2010-18-0200	18	20	COX-2000-18-0151
SBG-2010-18-0250	18	25	COX-2000-18-0201
SBG-2010-20-0100	20	10	COX-2000-20-0051
SBG-2010-20-0150	20	15	COX-2000-20-0101
SBG-2010-20-0200	20	20	COX-2000-20-0151

Commercial products distributed by UROVISION.

CHIBA NEEDLE

2-part Chiba needle

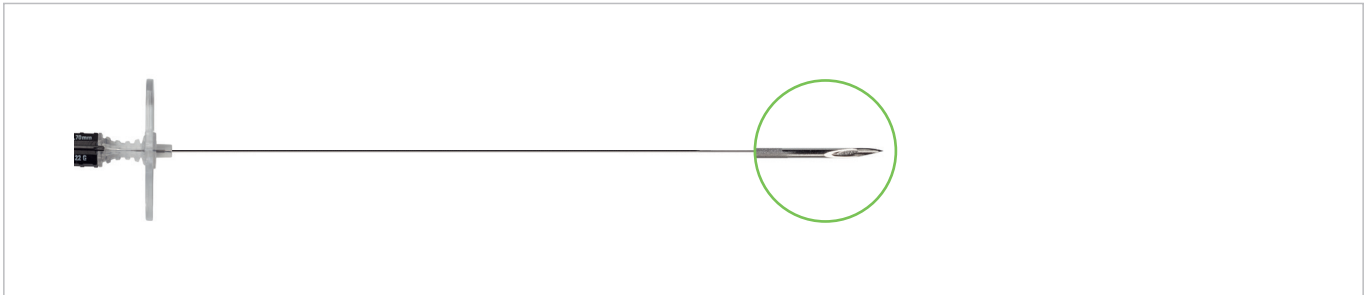

◆ Sandblasted for optimal ultrasound visibility

Order number	Size (G)	Length (cm)	Maximum guide wire
RN-632220	22	20	0.018"
RN-632228	22	28	0.018"

WWW.UROVISION.DE



UROVISION

Medi-Globe-Strasse 1-5
D-83101 Achenmühle,
Germany

☎ +49 (0) 80 32 / 973 - 400
📠 +49 (0) 80 32 / 973 - 411

SUPRAPUBIC
BLADDER DRAINAGE



SUPRAPUBIC BLADDER DRAINAGE

SUPRAVISION PUR Set	10.1
SUPRAVISION TUR Puncture Set	10.2
SUPRAVISION TUR Pigtail Catheter	10.3
SUPRAVISION Trocar Puncture Set with Balloon Catheter	10.4
SUPRAVISION Balloon Catheter & Sets	10.5

SUPRAVISION PUR Puncture and Exchange Set with pigtail and funnel

SET COMPONENTS

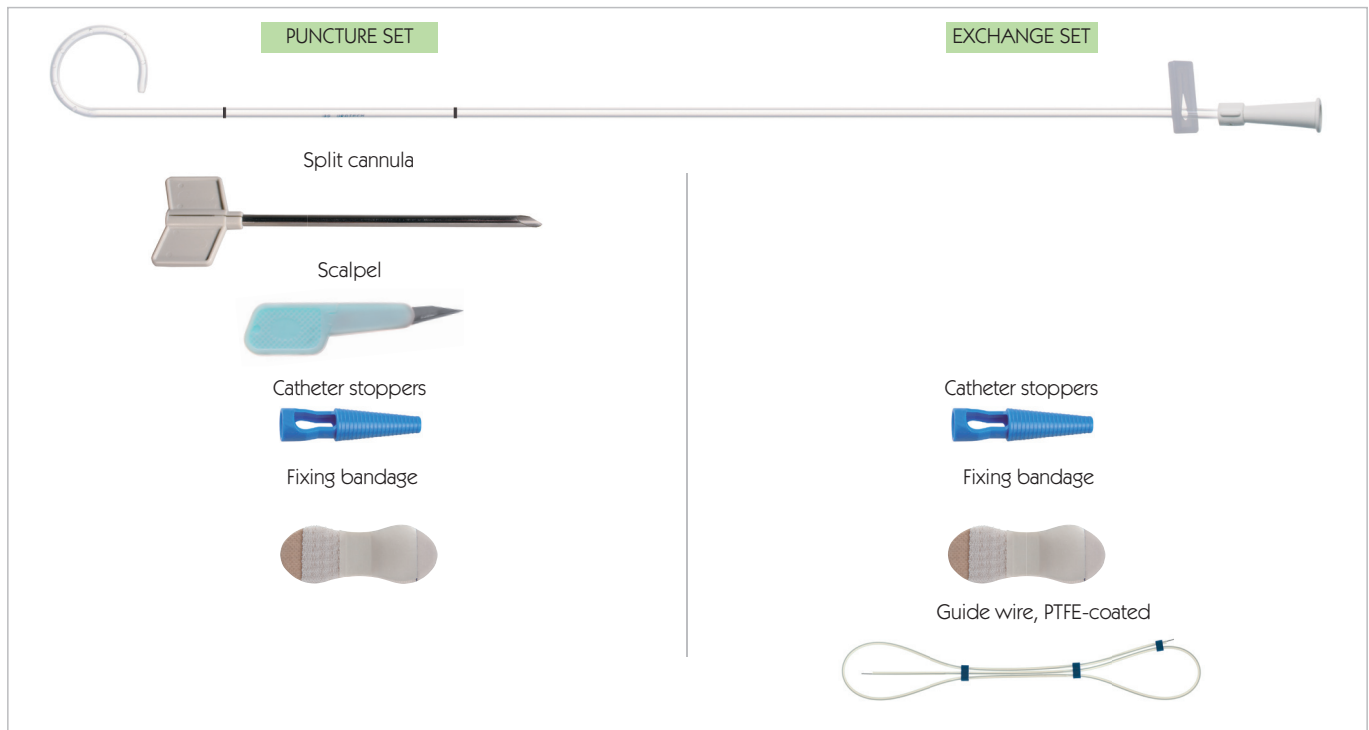

Pigtail Catheter

- ◆ Polyurethane
- ◆ Flexible pigtail prevents irritation
- ◆ Funnel for attaching a urine drainage bag
- ◆ Markings for exact positioning



Puncture Set				
Order number	Size (CH/FR)	Length (cm)	Split cannula diameter size (mm)	Split cannula length (mm)
SV-378565	08	65	3.6	120
SV-371065	10	65	4.6	120
SV-371265	12	65	5.6	120

Exchange Set						
Order number	Size (CH/FR)	Length (cm)	Wire (inch)	Wire length (cm)	Wire tip	Wire stiffness
SV-378566	08	65	0.038"	100	straight	standard
SV-371066	10	65	0.038"	100	straight	standard
SV-371266	12	65	0.038"	100	straight	standard
SV-371466	14	65	0.038"	100	straight	standard

SUPRAVISION TUR Puncture Set with pigtail and funnel

SET COMPONENTS

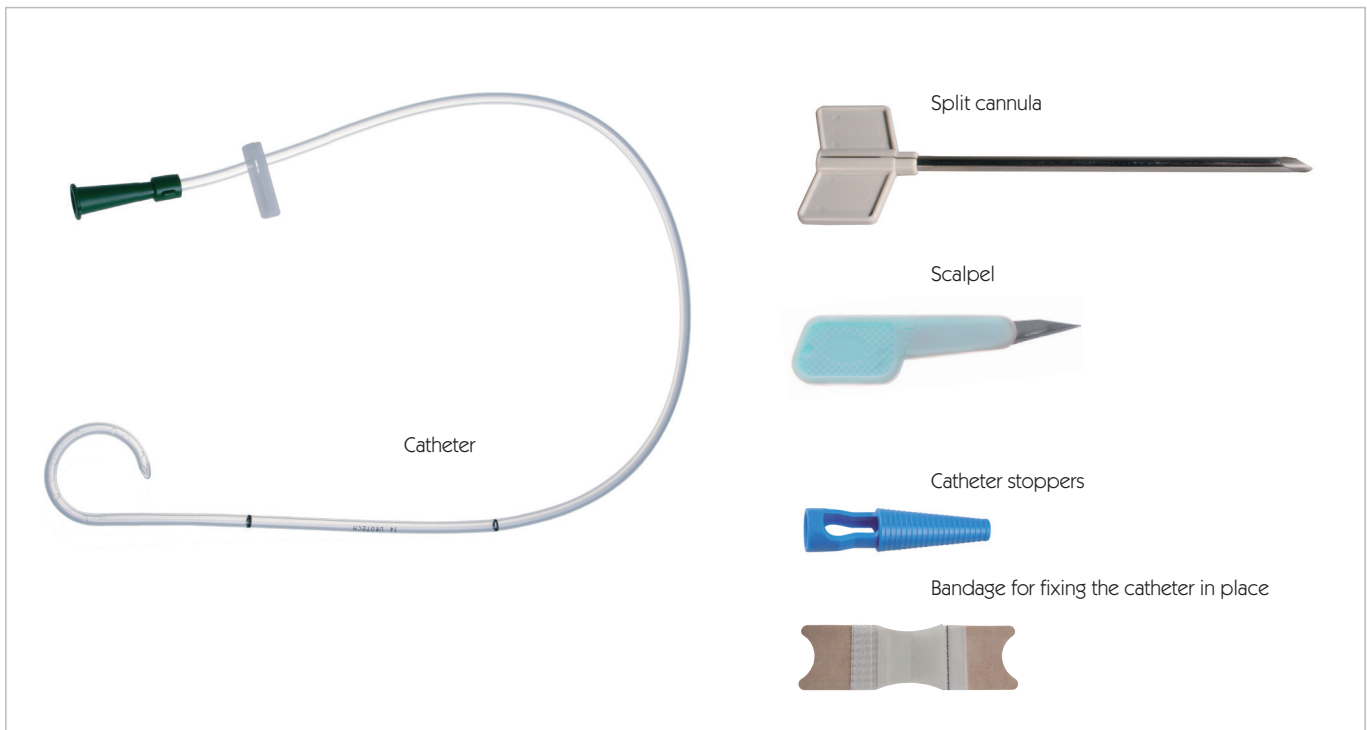

Pigtail Catheter

- ◆ Polyurethane
- ◆ Open or closed tip
- ◆ Optimal for draining and rinsing during transurethral resection
- ◆ Flexible pigtail prevents irritation
- ◆ Funnel for attaching a urine drainage bag
- ◆ Markings for exact positioning



Puncture Set					
Order number Open tip	Order number Closed tip	Size (CH/FR)	Length (cm)	Split cannula diameter size (mm)	Split cannula length (mm)
SV-391540	SV-391640	14	65	5.6	120

SUPRAVISION TUR PIGTAIL CATHETER

With pigtail and funnel

DESCRIPTION

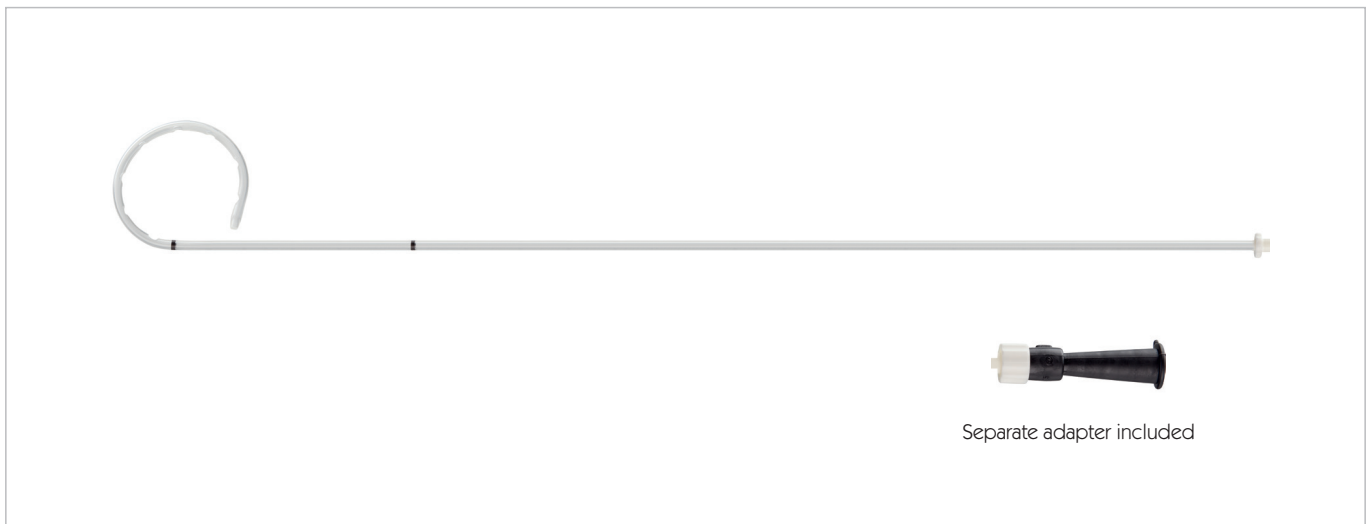

TUR Pigtail Catheter

- ◆ Polyurethane
- ◆ Separate funnel for attachment
- ◆ Open tip
- ◆ Optimal for draining and rinsing during TUR
- ◆ Flexible pigtail prevents irritation
- ◆ Excellent urine routing due to extra-large drainage openings in the pigtail
- ◆ Detachable funnel for connecting a urine drainage bag
- ◆ Markings for exact positioning
- ◆ Suitable for reusable trocars

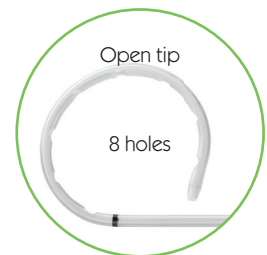

Order number	Size (CH/FR)	Length (cm)
SV-391865-ML	14	65

SUPRAVISION INTEGRAL TROCAR

Suprapubic catheter with integrated balloon, 100% silicone

SET COMPONENTS

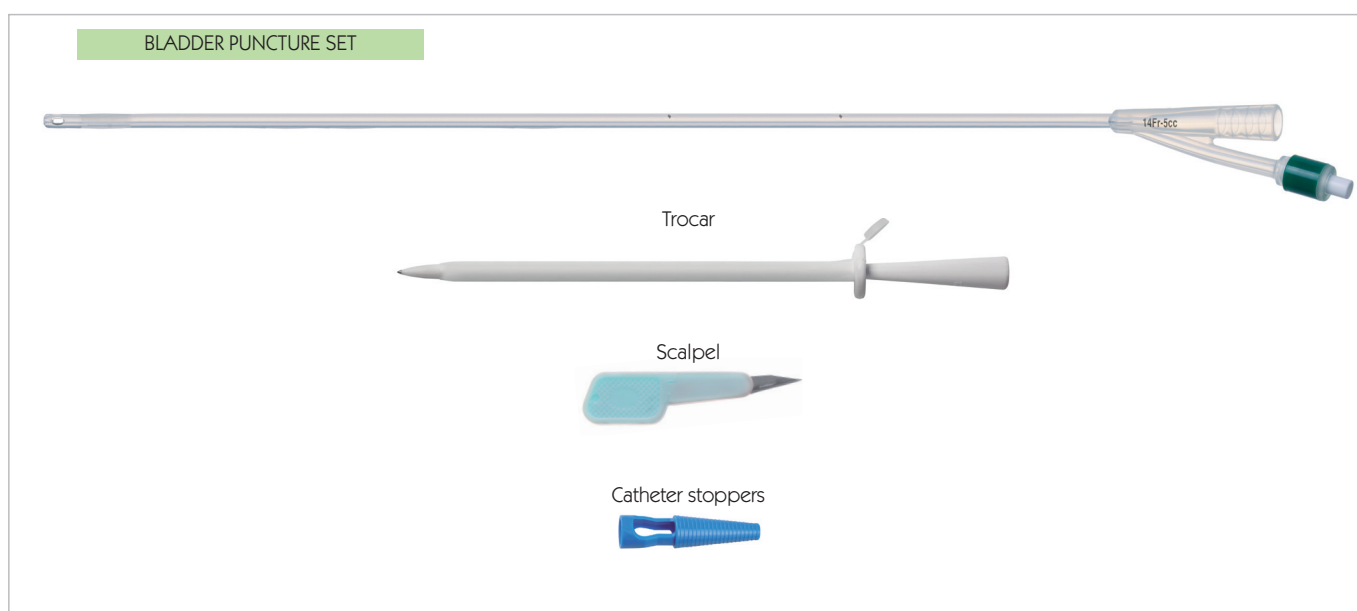

Suprapubic Catheter

- ◆ Completely silicone catheter with integrated balloon, enabling easier catheter placement
- ◆ 100% silicone, transparent with an open tip
- ◆ Excellent flow-through rate
- ◆ Very low propensity for encrustation
- ◆ Low-risk, easy handling
- ◆ Rounded tip for easier catheter placement
- ◆ Reinforced funnel attachment to prevent funnel from ripping and to enable secure connection of the urine drainage bag
- ◆ Transparent with integrated x-ray contrast strips
- ◆ Trocar properties: Low risk of bleeding, because unlike the split cannulas, there is no punching effect

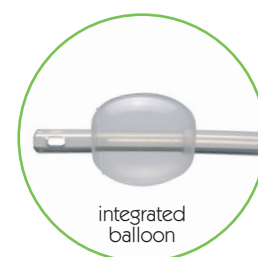

Bladder Puncture Set			
Order number With scalpel	Size (CH/FR)	Length (cm)	Balloon capacity (ml)
SV-201240	12	40	5
SV-201440	14	40	5
SV-201640	16	40	10

SUPRAVISION INTEGRAL STANDARD

Suprapubic catheter with integrated balloon, 100% silicone

SET COMPONENTS

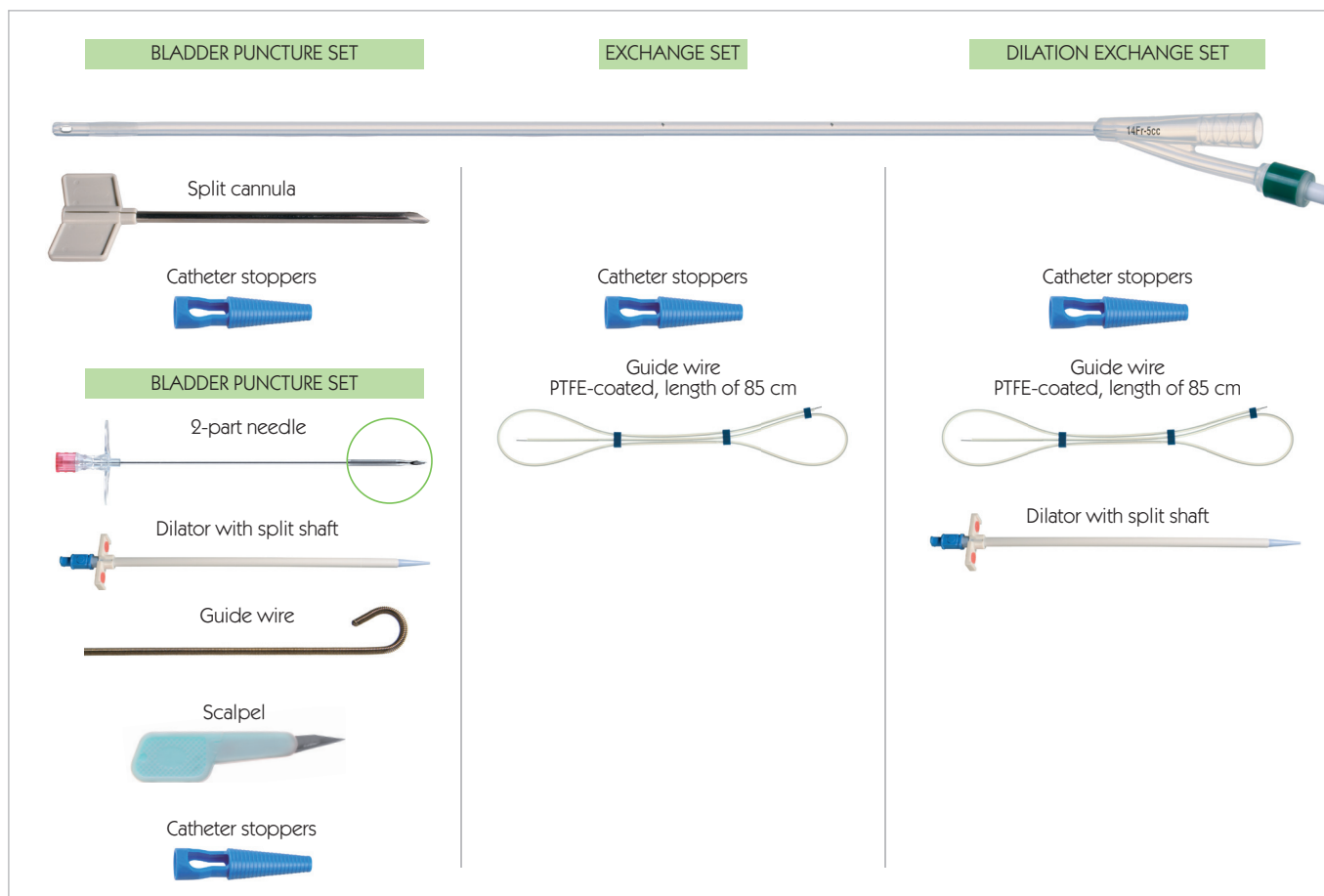

Suprapubic Catheter

- ◆ Completely silicone catheter with integrated balloon, enabling easier catheter placement
- ◆ 100% silicone, transparent with an open tip
- ◆ Excellent flow-through rate
- ◆ Very low propensity for encrustation
- ◆ Low-risk, easy handling
- ◆ Rounded tip for easier catheter placement
- ◆ Reinforced funnel attachment to prevent funnel from ripping and to enable secure connection of the urine drainage bag
- ◆ Transparent with integrated x-ray contrast strips
- ◆ Very good lubricating properties
- ◆ Stable inner and outer coating

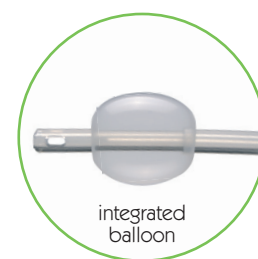

VISIOSLIDE Special Coating

- ◆ Improved lubricating properties, wear-resistant inside and outside
- ◆ Lower propensity for encrustation, resulting in increased life cycle

SUPRAVISION INTEGRAL STANDARD

Suprapubic catheter with integrated balloon, 100% silicone

Single catheter					
Order number Normal variant	Order number Normal variant with VISIOSLIDE	Size (CH/FR)	Length (cm)	Balloon capacity (ml)	Suitable for wire (inch)
SV-310835	SV-310835-SC	8	35	1.5	0.028"
SV-311040	SV-311040-SC	10	40	3	0.032"
SV-311240	SV-311240-SC	12	40	5	0.038"
SV-311440	SV-311440-SC	14	40	5	0.038"
SV-311640	SV-311640-SC	16	40	10	0.038"
SV-311840	SV-311840-SC	18	40	10	0.038"
SV-312040	SV-312040-SC	20	40	10	0.038"
SV-312240	SV-312240-SC	22	40	10	0.038"
SV-312440	SV-312440-SC	24	40	10	0.038"

Single catheter					
Order number Short variant	Order number Short variant with VISIOSLIDE	Size (CH/FR)	Length (cm)	Balloon capacity (ml)	Suitable for wire (inch)
SV-321025	SV-321025-SC	10	25	3	0.032"
SV-321225	SV-321225-SC	12	25	5	0.038"
SV-321425	SV-321425-SC	14	25	5	0.038"
SV-321625	SV-321625-SC	16	25	10	0.038"
SV-321825	SV-321825-SC	18	25	10	0.038"
SV-322025	SV-322025-SC	20	25	10	0.038"
SV-322225	SV-322225-SC	22	25	10	0.038"

Bladder Puncture Set					
Order number With scalpel		Size (CH/FR)	Length (cm)	Balloon capacity (ml)	Wire (inch)
SV-300835		8	35	1.5	0.028"
SV-301025		10	25	3	0.032"
SV-301040		10	40	3	0.032"
SV-301225		12	25	5	0.038"
SV-301240		12	40	5	0.038"
SV-301440		14	40	5	0.038"

SUPRAPUBIC BLADDER DRAINAGE

Initial Bladder Puncture Set with VISIOSLIDE Special Coating				
Order number With scalpel With VISIOSLIDE	Size (CH/FR)	Length (cm)	Balloon capacity (ml)	Wire (inch)
SV-300835-SC	8	35	1.5	0.028"
SV-301040-SC	10	40	3	0.032"
SV-301240-SC	12	40	5	0.038"
SV-301440-SC	14	40	5	0.038"

Exchange Set					
Order number Normal variant	Order number Normal variant with VISIOSLIDE	Size (CH/FR)	Length (cm)	Balloon capacity (ml)	Wire (inch)
SV-330835	SV-330835-SC	8	35	1.5	0.028"
SV-331040	SV-331040-SC	10	40	3	0.032"
SV-331240	SV-331240-SC	12	40	5	0.038"
SV-331440	SV-331440-SC	14	40	5	0.038"
SV-331640	SV-331640-SC	16	40	10	0.038"
SV-331840	SV-331840-SC	18	40	10	0.038"
SV-332040	SV-332040-SC	20	40	10	0.038"

Dilation exchange set				
Order number	Size (CH/FR)	Length (cm)	Balloon capacity (ml)	Wire (inch)
SV-341040	10	40	3	0.032"
SV-341240	12	40	5	0.038"
SV-341440	14	40	5	0.038"
SV-341640	16	40	10	0.038"
SV-341840	18	40	10	0.038"
SV-342040	20	40	10	0.038"

Bladder Puncture Set with 2-part Puncture Needle				
Order number	Size (CH/FR)	Length (cm)	Balloon capacity (ml)	Wire (inch)
SV-101240	12	40	5	0.035"

SUPRAVISION SOFT

Silicone-coated balloon catheter with latex core

SET COMPONENTS

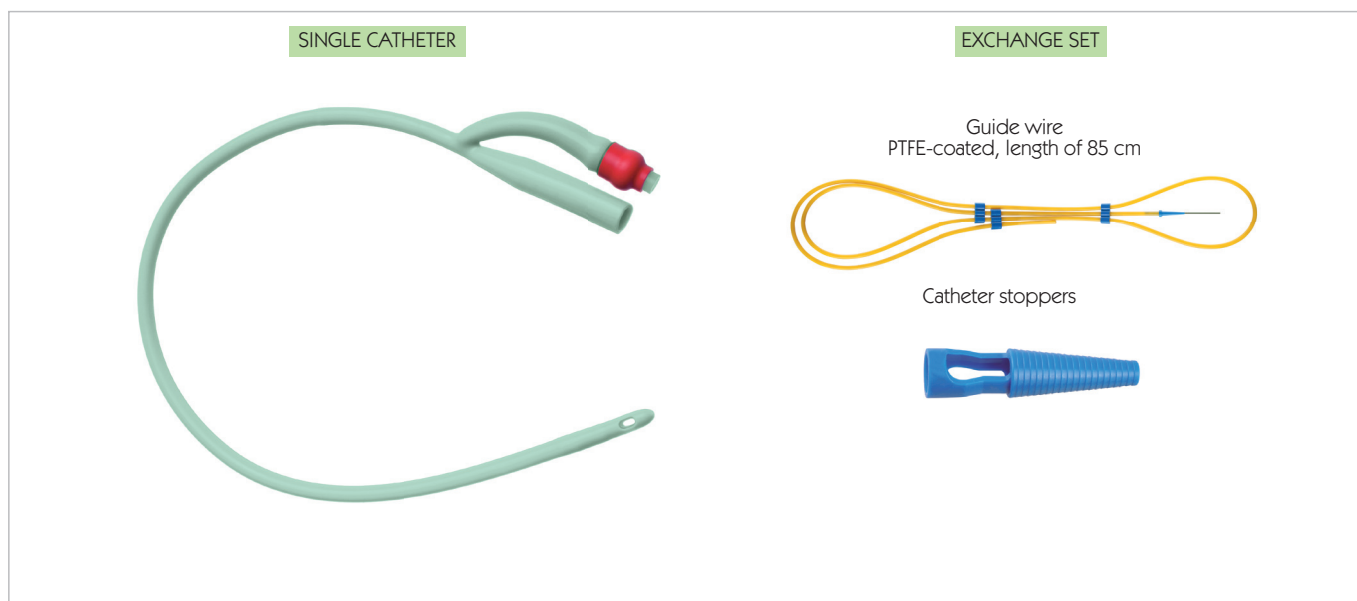

Balloon Catheter

- ◆ The advantages of latex and silicone are combined in one catheter by using a silicone layer on a latex core
- ◆ The funnel attachment does not fall off and is optimally secured on the bag system connector
- ◆ Soft balloon catheter with a high level of wearing comfort for the patient, so it is ideally suited for long-term drainage
- ◆ The catheter has very high balloon stability, largely eliminating the possibility of a rupture or subsequent blockage
- ◆ The highly rounded tip enables easy placement of catheter
- ◆ Open tip

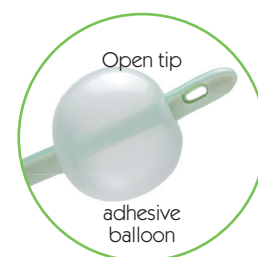

Order number Single catheter	Order number Exchange set	Size (CH/FR)	Length (cm)	Balloon capacity (ml)	Wire (inch)
SV-361240	SV-351240	12	40	10	0.038"
SV-361440	SV-351440	14	40	10	0.038"
SV-361640	SV-351640	16	40	10	0.038"
SV-361840	SV-351840	18	40	10	0.038"
SV-362040	SV-352040	20	40	10	0.038"
SV-362240	-	22	40	10	0.038"
SV-362440	-	24	40	10	0.038"
SV-362640	-	26	40	10	0.038"

SUPRAVISION INTEGRAL PIGTAIL

Balloon catheter with pigtail tip, 100% silicone

SET COMPONENTS

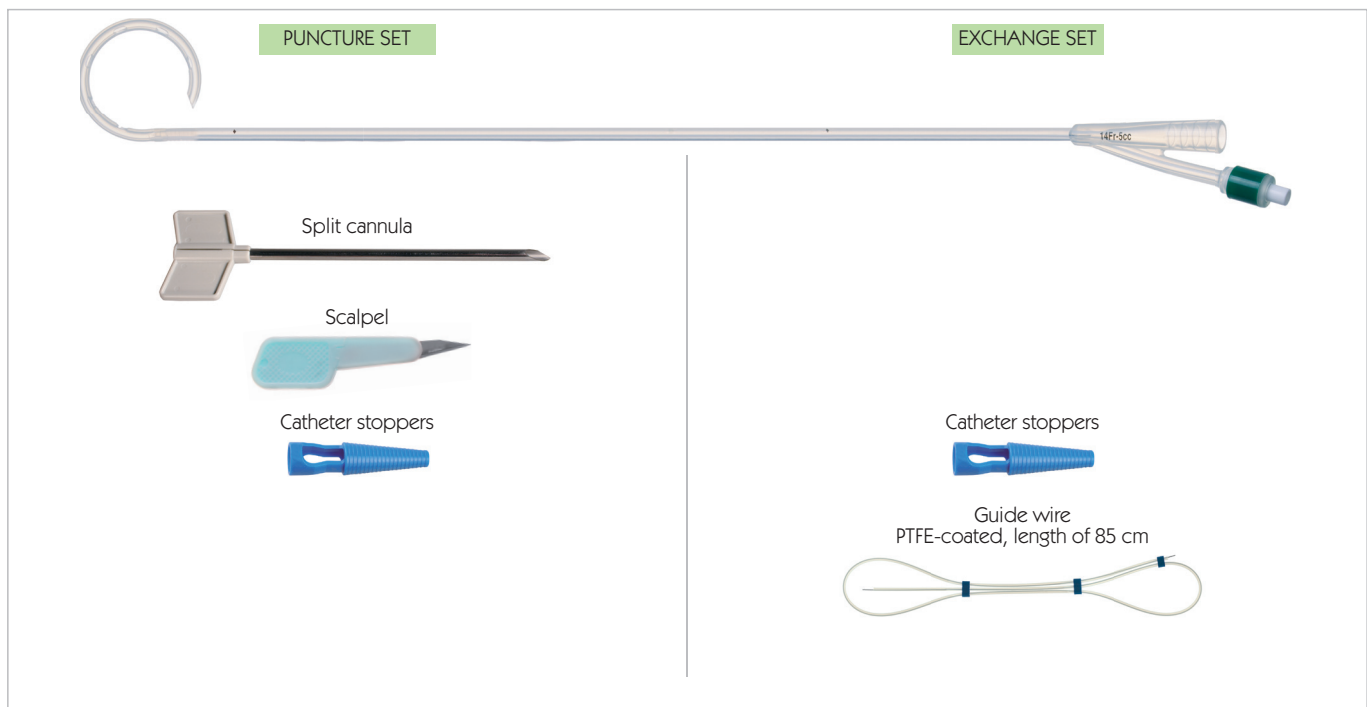

Balloon Catheter

- ◆ 6 drainage openings in the pigtail, providing very high drainage performance
- ◆ Silicone for optimal tissue compatibility
- ◆ Less irritation when placing and exchanging the catheters due to integrated balloon
- ◆ Very low propensity for encrustation
- ◆ Reinforced funnel attachment to prevent funnel from ripping and to enable secure connection of the urine drainage bag
- ◆ With integrated balloon
- ◆ 100% silicone



SUPRAVISION INTEGRAL PIGTAIL

Balloon catheter with pigtail tip, 100% silicone

Single catheter				
Order number	Size (CH/FR)	Length (cm)	Balloon capacity (ml)	Suitable for wire (inch)
SV-401240	12	40	5	0.038"
SV-401440	14	40	5	0.038"
SV-401640	16	40	10	0.038"
SV-401840	18	40	10	0.038"

Puncture Set				
Order number	Size (CH/FR)	Length (cm)	Balloon capacity (ml)	Suitable for wire (inch)
SV-411240	12	40	5	0.038"
SV-411440	14	40	5	0.038"

Exchange Set				
Order number	Size (CH/FR)	Length (cm)	Balloon capacity (ml)	Wire (inch)
SV-421240	12	40	5	0.038"
SV-421440	14	40	5	0.038"
SV-421640	16	40	10	0.038"

SUPRAVISION INTEGRAL SPECIAL TIP

Suprapubic dilatation balloon catheter with flat integrated balloon, 100% silicone

DESCRIPTION

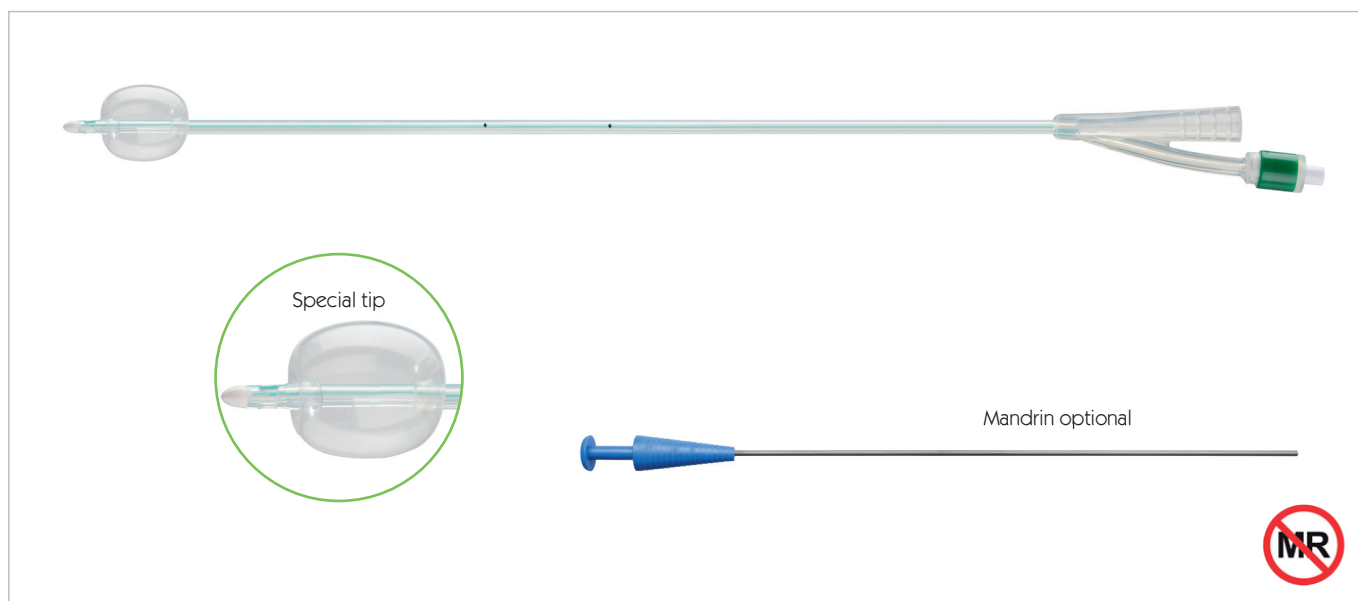

Dilatation balloon catheter

- ◆ Completely 100% silicone catheter with flat integrated balloon, enabling easier catheter placement
- ◆ Shaped and reinforced open tip
- ◆ Dilatation is facilitated by the metal-reinforced tip and exact adaptation to the guide wire
- ◆ Very low incidence of encrustation, low-risk, and easy application
- ◆ Optional stylet; possible to probe the puncture site again if catheter is dislocated. This can help to avoid repeated punctures

Order number Without stylet	Order number With stylet	Size (CH/FR)	Length (cm)	Balloon capacity (ml)
SV-441240	SV-511240	12	40	5
SV-441440	SV-511440	14	40	5
SV-441640	SV-511640	16	40	10
SV-441840	SV-511840	18	40	10
SV-442040	SV-512040	20	40	10

Suitable for 0.035" guide wire Wire order number: ST-291035

WWW.UROVISION.DE



UROVISION

Medi-Globe-Strasse 1-5
D-83101 Achenmühle,
Germany

☎ +49 (0) 80 32 / 973 - 400
📠 +49 (0) 80 32 / 973 - 411

TRANSURETHRAL
CATHETERS



TRANSURETHRAL CATHETERS

Transurethral Catheters	11.1
Extension Catheters	11.09
VISIOKON Catheter	11.10

VISIOCATH BALLOON CATHETER

100% silicone

DESCRIPTION

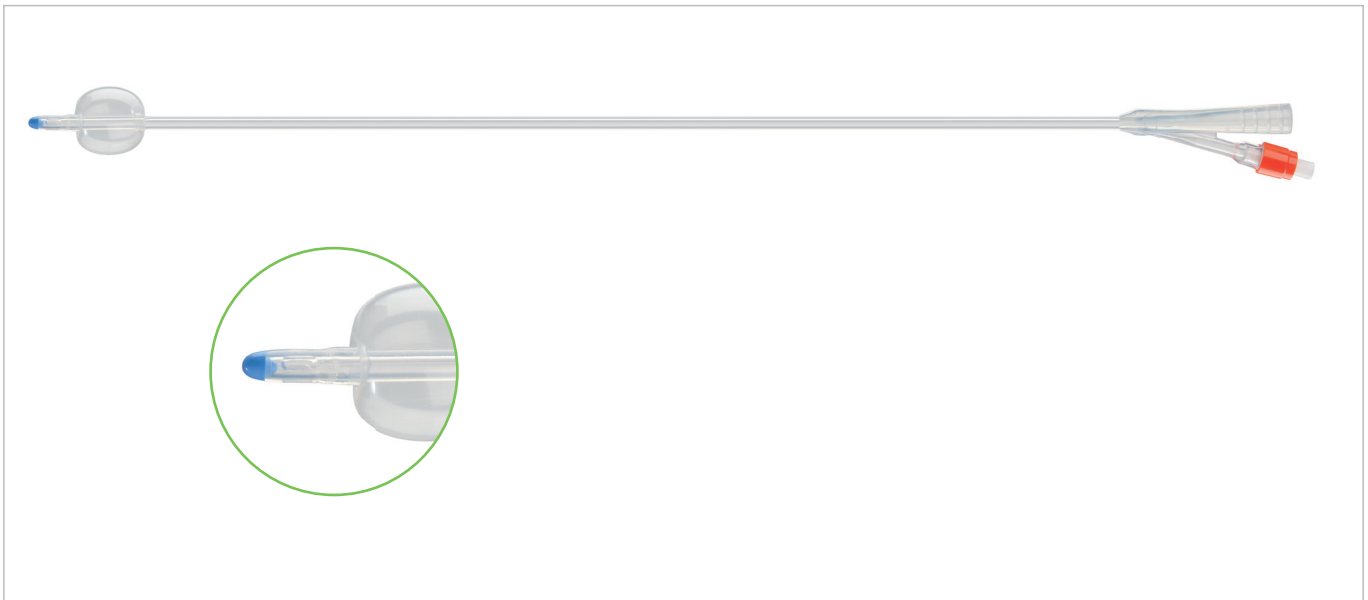

Balloon Catheter

- ◆ Silicone for optimal tissue compatibility
- ◆ Transparent with integrated x-ray contrast strips
- ◆ Reinforced funnel attachment for secure connection of urine drainage bag

Order number	Size (CH/FR)	Length (cm)	Balloon capacity (ml)
KW-331210	12	40	5 -10
KW-331410	14	40	5 -10
KW-331610	16	40	5 -10
KW-331810	18	40	5 -10
KW-332010	20	40	5 -10
KW-332210	22	40	5 -10

VISI-ESOFIT BALLOON CATHETER

Extra soft, 100% silicone

DESCRIPTION

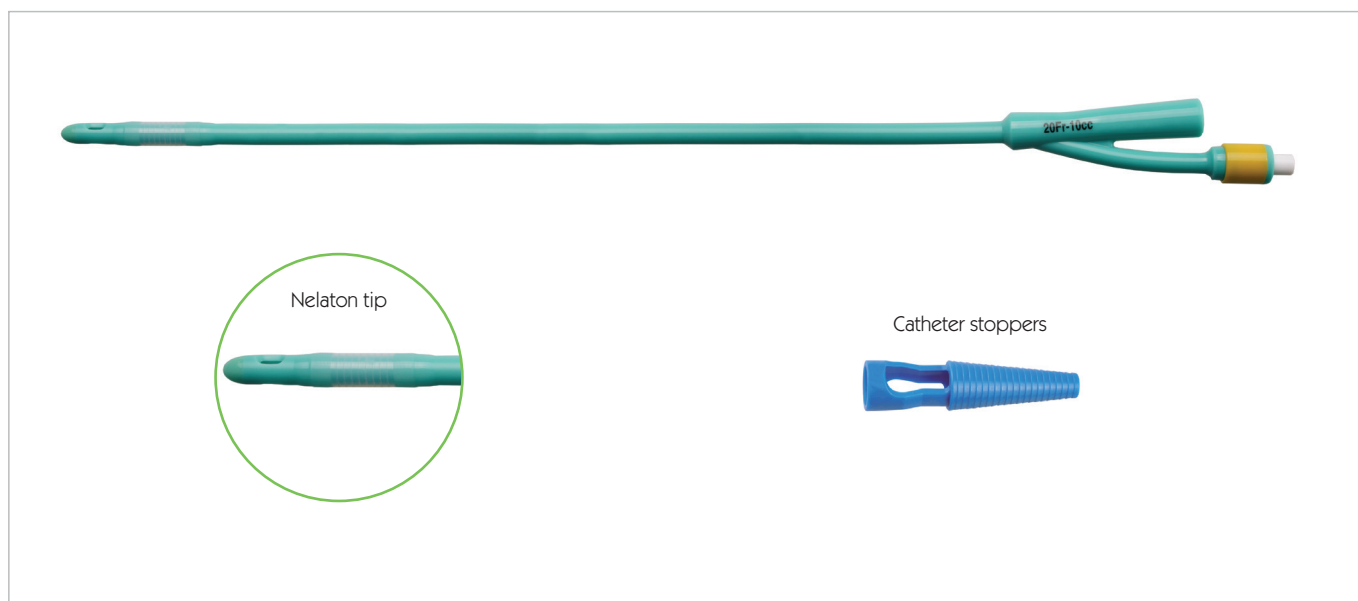

Balloon Catheter

- ◆ Silicone for optimal tissue compatibility
- ◆ Very soft balloon catheter for low irritation and a very high comfort level for the patient
- ◆ Very low propensity for encrustation
- ◆ Very good long-term draining performance due to large inner diameter

Order number	Size (CH/FR)	Length (cm)	Balloon capacity (ml)
KG-300810	8	30	5
KG-301010	10	30	5
KG-301210	12	40	10
KG-301410	14	40	10
KG-301610	16	40	10
KG-301810	18	40	10
KG-302010	20	40	10
KG-302210	22	40	10
KG-302410	24	40	10
KG-302610	26	40	10

VISI-INTEGRAL BALLOON CATHETER

With integrated balloon, 100% silicone

DESCRIPTION

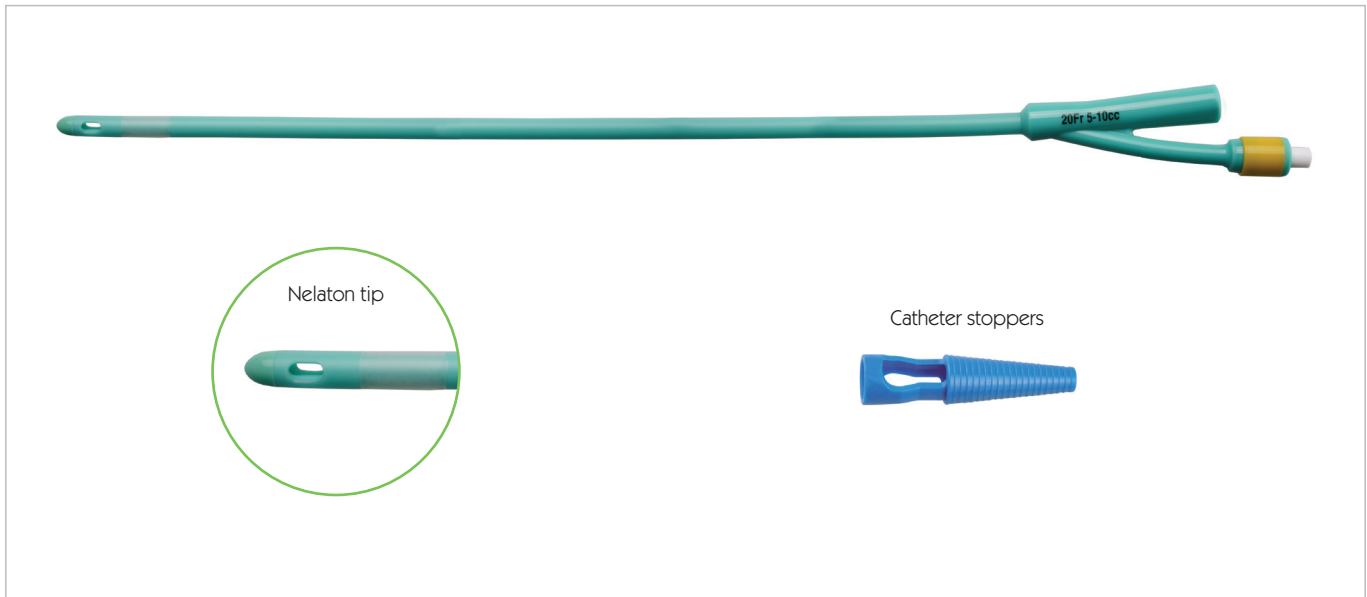

Balloon Catheter

- ◆ Gently dilating Nelaton tip
- ◆ Silicone for optimal tissue compatibility
- ◆ Less irritation in the urethra when placing and exchanging the catheters due to integrated balloon
- ◆ Very low propensity for encrustation
- ◆ Reinforced funnel attachment to prevent funnel from ripping and to enable secure connection of the urine drainage bag

Order number Nelaton tip, closed	Order number Nelaton tip with end hole	Size (CH/FR)	Length (cm)	Balloon capacity (ml)
KI-101040	KI-101040-SL	10	30	3
KI-101240	KI-101240-SL	12	40	5
KI-101440	KI-101440-SL	14	40	10
KI-101640	KI-101640-SL	16	40	10
KI-101840	KI-101840-SL	18	40	10
KI-102040	KI-102040-SL	20	40	10
KI-102240	KI-102240-SL	22	40	10
KI-102440	KI-102440-SL	24	40	10
KI-102640	KI-102640-SL	26	40	10

VISISOFT BALLOON CATHETER

With latex core and solid silicone coating inside and outside

DESCRIPTION

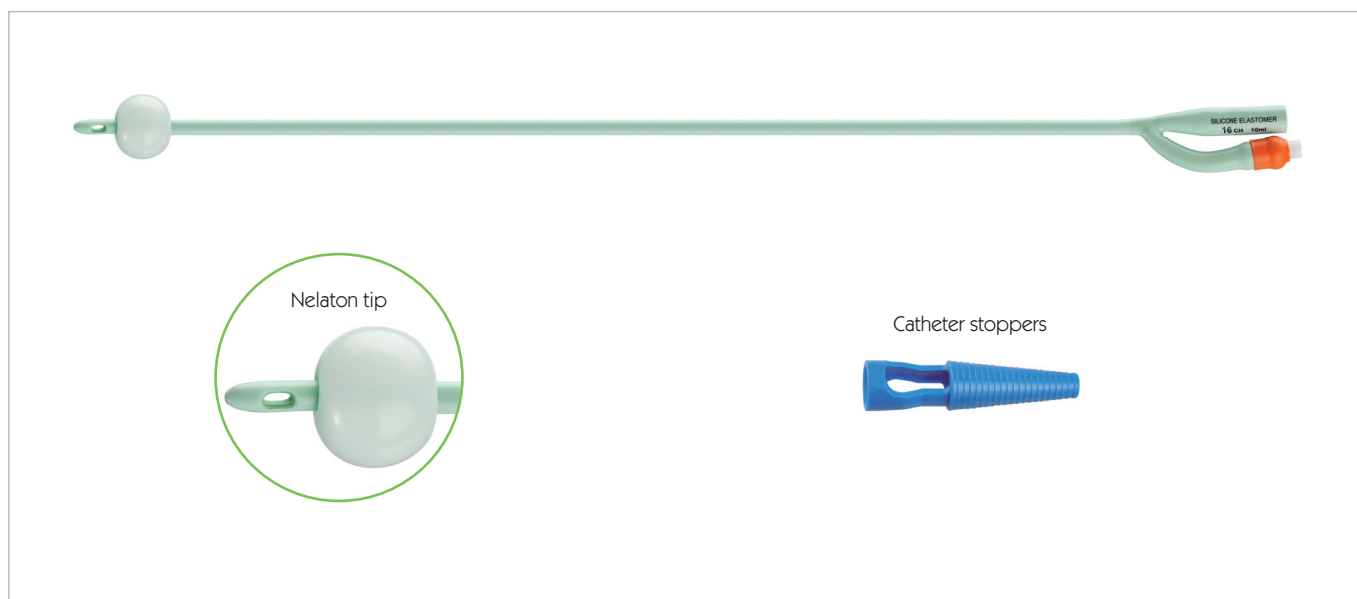

Balloon Catheter

- ◆ Nelaton tip
- ◆ Silicone coating for optimal tissue compatibility
- ◆ High balloon stability, which largely eliminates the possibility of balloon ruptures and subsequent blockage
- ◆ Soft balloon catheter offers wearing comfort for patients and is well suited for long-term drainage
- ◆ Non-rip funnel attachment offers ideal anchoring for bag system step connector
- ◆ Kidney stone resistance of the balloon

Order number Nelaton tip, closed	Order number Nelaton tip with end hole	Size (CH/FR)	Length (cm)	Balloon capacity (ml)
KI-200810	-	8	30	5
KI-201010	-	10	30	5
KI-201210	KI-201210-SL	12	40	10
KI-201410	KI-201410-SL	14	40	10
KI-201610	KI-201610-SL	16	40	10
KI-201810	KI-201810-SL	18	40	10
KI-202010	KI-202010-SL	20	40	10
KI-202210	KI-202210-SL	22	40	10
KI-202410	KI-202410-SL	24	40	10
KI-202610	KI-202610-SL	26	40	10

VISI-INTEGRAL SOFT BALLOON CATHETER

100% silicone

DESCRIPTION

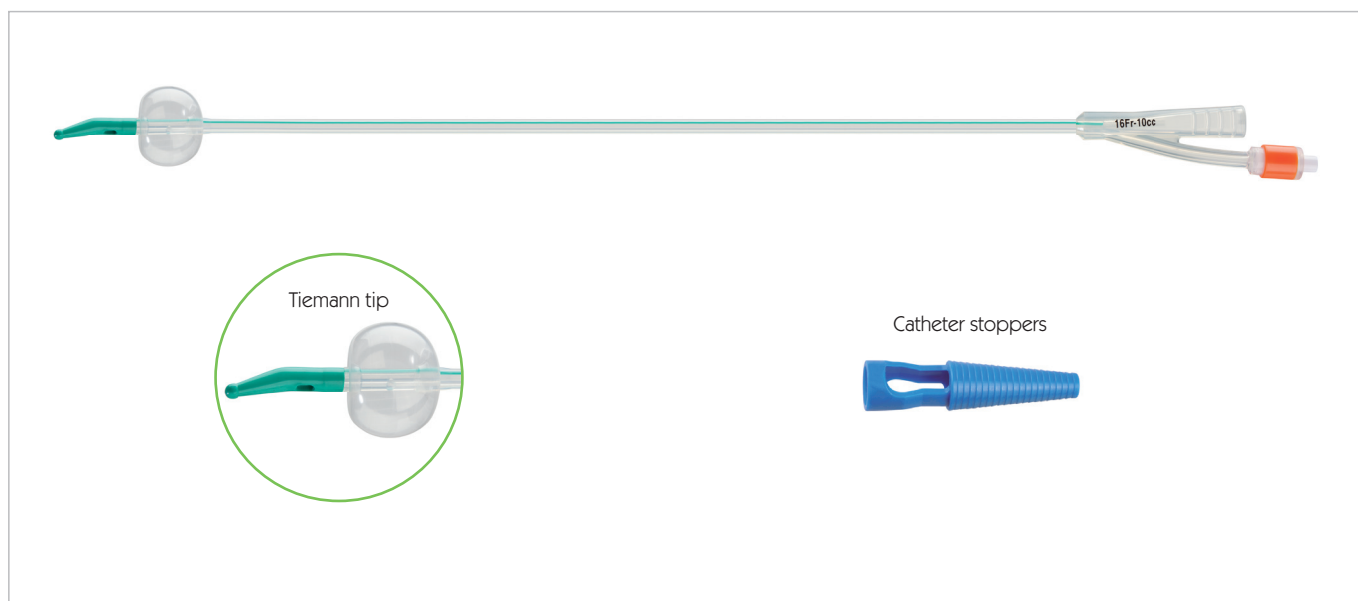

Balloon Catheter

- ◆ Silicone for optimal tissue compatibility
- ◆ Secure placement of the catheter in the bladder due to special balloon properties
- ◆ Easier placement and exchange of catheters due to integrated balloon
- ◆ Very low propensity for encrustation
- ◆ Balloon catheter with rotation-secure atraumatic Tiemann tip
- ◆ Optimally suited for long and short-term drainage

Order number	Size (CH/FR)	Length (cm)	Balloon capacity (ml)
KI-401010	10	31	5
KI-401210	12	40	5
KI-401410	14	40	5
KI-401610	16	40	10
KI-401810	18	40	10
KI-402010	20	40	10
KI-402210	22	40	10
KI-402410	24	40	10

VISIOCATH BALLOON CATHETER

100% silicone

DESCRIPTION

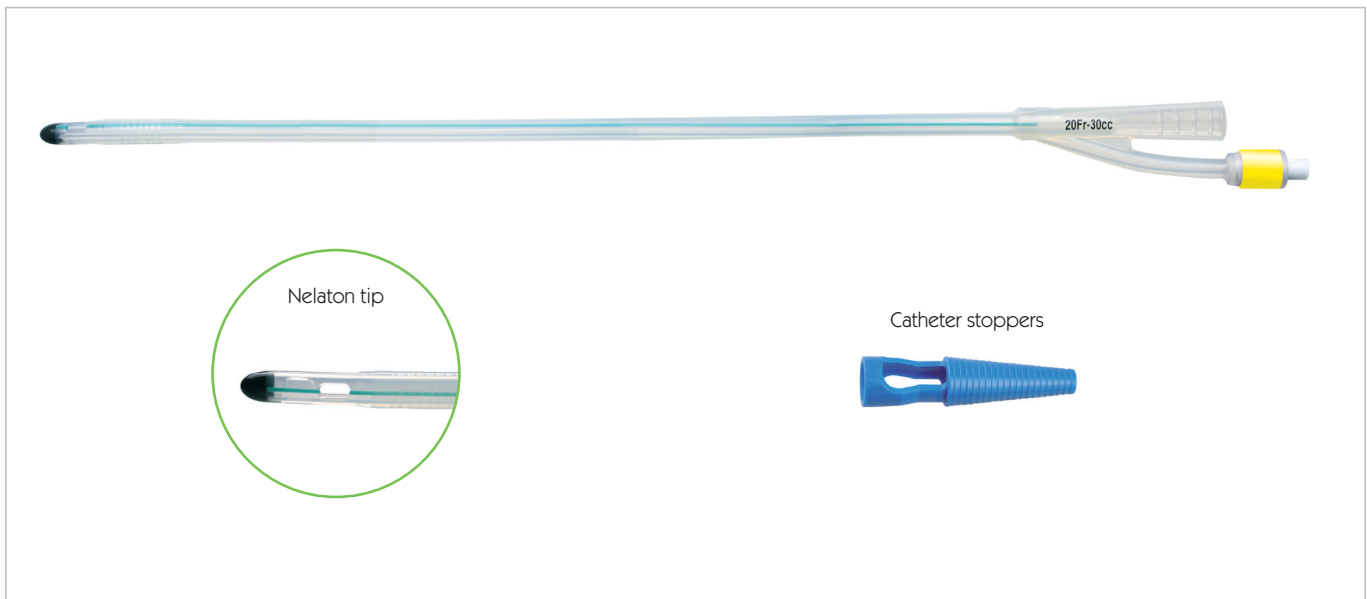

Balloon Catheter

- ◆ With VISIOSLIDE special coating or uncoated (standard)
- ◆ Nelaton tip
- ◆ For women, men, and children
- ◆ Silicone for optimal tissue compatibility
- ◆ High balloon stability with low diffusion
- ◆ Reinforced funnel attachment to prevent funnel from ripping and to enable secure connection of the urine drainage bag
- ◆ Transparent with integrated x-ray contrast strips
- ◆ Also available as a children's catheter with stiffening mandrin
- ◆ Very good lubricating properties
- ◆ Stable inner and outer coating

VISIOSLIDE Special Coating

- ◆ Improved lubricating properties, wear-resistant inside and outside
- ◆ Lower propensity for encrustation, resulting in increased life cycle

TRANSURETHRAL CATHETER

Balloon Catheter for Men – Standard				
Order number Nelaton tip, closed	Order number Nelaton tip with end hole	Size (CH/FR)	Length (cm)	Balloon capacity (ml)
KW-441210	KW-441210-SL	12	40	10
KW-441410	KW-441410-SL	14	40	10
KW-441610	KW-441610-SL	16	40	10
KW-441810	KW-441810-SL	18	40	10
KW-442010	KW-442010-SL	20	40	10
KW-442210	KW-442210-SL	22	40	10
KW-442410	KW-442410-SL	24	40	10
KW-442610	KW-442610-SL	26	40	10
KW-441430	KW-441430-SL	14	40	30
KW-441630	KW-441630-SL	16	40	30
KW-441830	KW-441830-SL	18	40	30
KW-442030	KW-442030-SL	20	40	30
KW-442230	KW-442230-SL	22	40	30
KW-442430	KW-442430-SL	24	40	30

Balloon Catheter for Men with Visioslide Special Coating			
Order number	Size (CH/FR)	Length (cm)	Balloon capacity (ml)
KW-441210-SC	12	40	10
KW-441410-SC	14	40	10
KW-441610-SC	16	40	10
KW-441810-SC	18	40	10
KW-442010-SC	20	40	10
KW-442210-SC	22	40	10
KW-442410-SC	24	40	10
KW-442610-SC	26	40	10

VISIOCATH BALLOON CATHETER

100% silicone

Balloon Catheter for Women			
Order number	Size (CH/FR)	Length (cm)	Balloon capacity (ml)
KW-451210	12	22	10
KW-451410	14	22	10
KW-451610	16	22	10
KW-451810	18	22	10
KW-452010	20	22	10
KW-452210	22	22	10
KW-452410	24	22	10

VISIOCATH BALLOON CATHETER

Balloon catheter made of latex, siliconized

DESCRIPTION

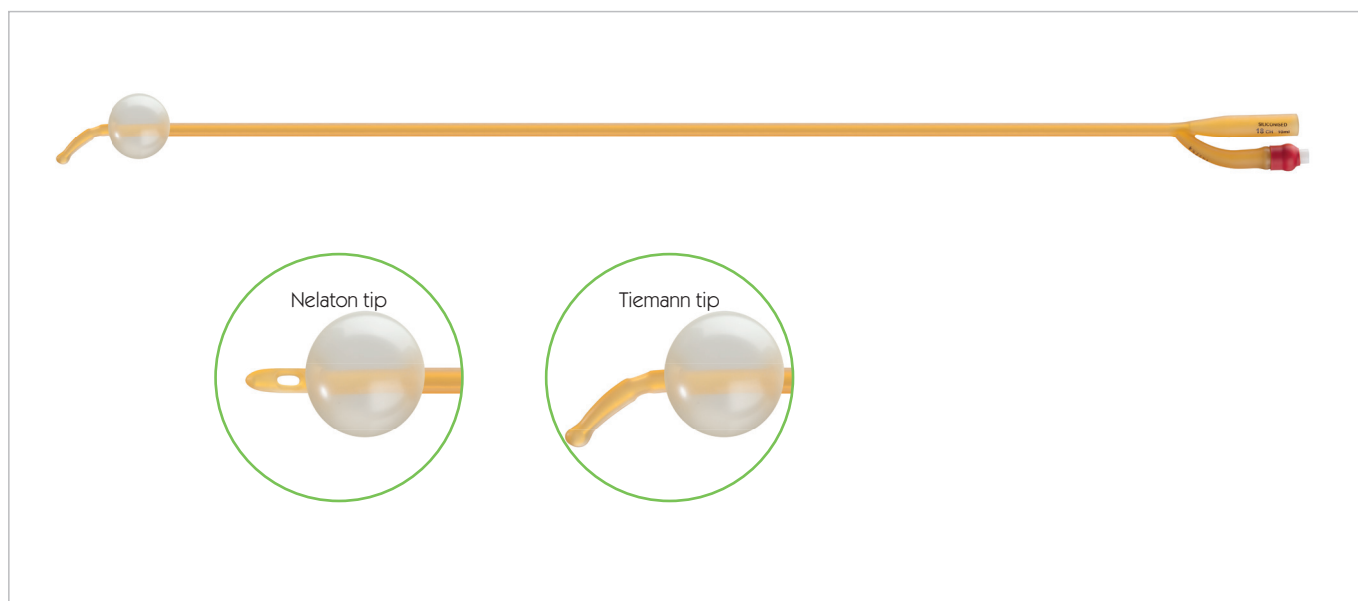

Balloon Catheter

- ◆ Siliconized latex catheter
- ◆ Available with Nelaton and Tiemann tips
- ◆ Balloon enables secure attachment of catheter
- ◆ Suitable for a short indwelling time

Order number Nelaton tip	Order number Tiemann tip	Size (CH/FR)	Length (cm)	Balloon capacity (ml)
KL-011210	KL-021210	12	41	10
KL-011410	KL-021410	14	41	10
KL-011610	KL-021610	16	41	10
KL-011810	KL-021810	18	41	10
KL-012010	KL-022010	20	41	10
KL-012210	KL-022210	22	41	10
KL-012410	KL-022410	24	41	10
KL-012610		26	41	10

WHISTLE TIP CATHETER

100% silicone

DESCRIPTION

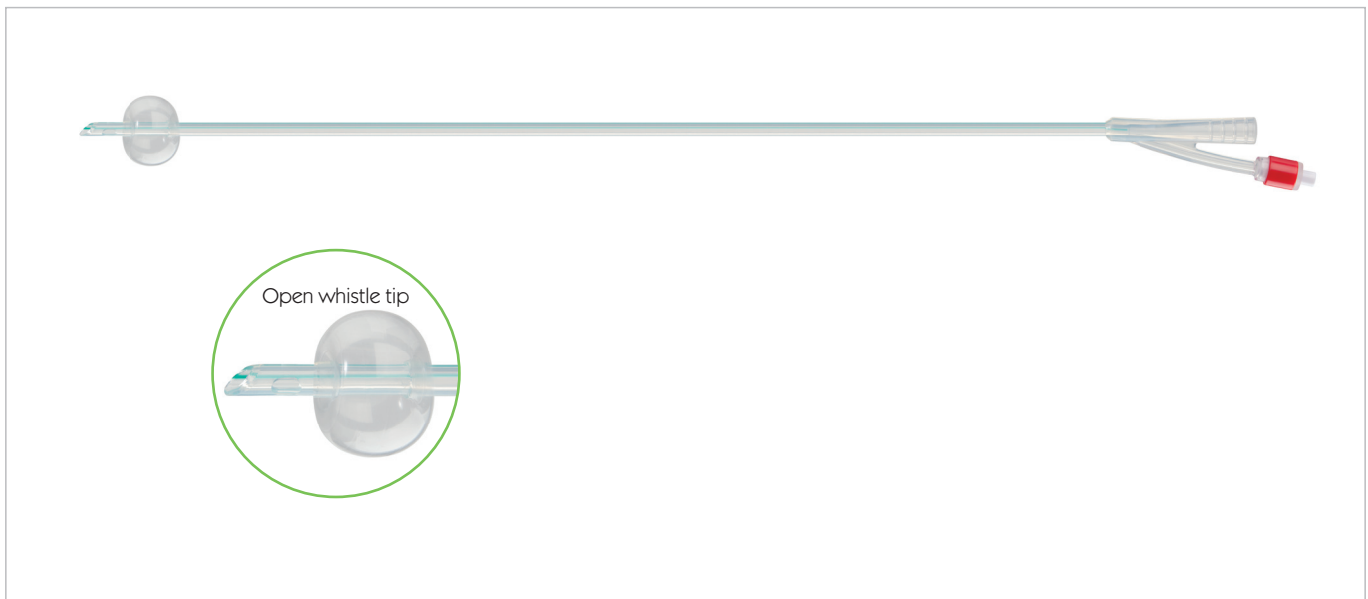

Whistle tip catheter

- ◆ With atraumatic, open and short whistle tip
- ◆ Especially for patients receiving enteral feeding
- ◆ Silicone for optimal tissue compatibility
- ◆ Reliable drainage performance due to large inside diameter for problematic urine findings

Order number	Size (CH/FR)	Length (cm)	Balloon capacity (ml)
KF-501610	16	40	10
KF-501810	18	40	10
KF-502010	20	40	10

UROVISION EXTENSION CATHETER

DESCRIPTION

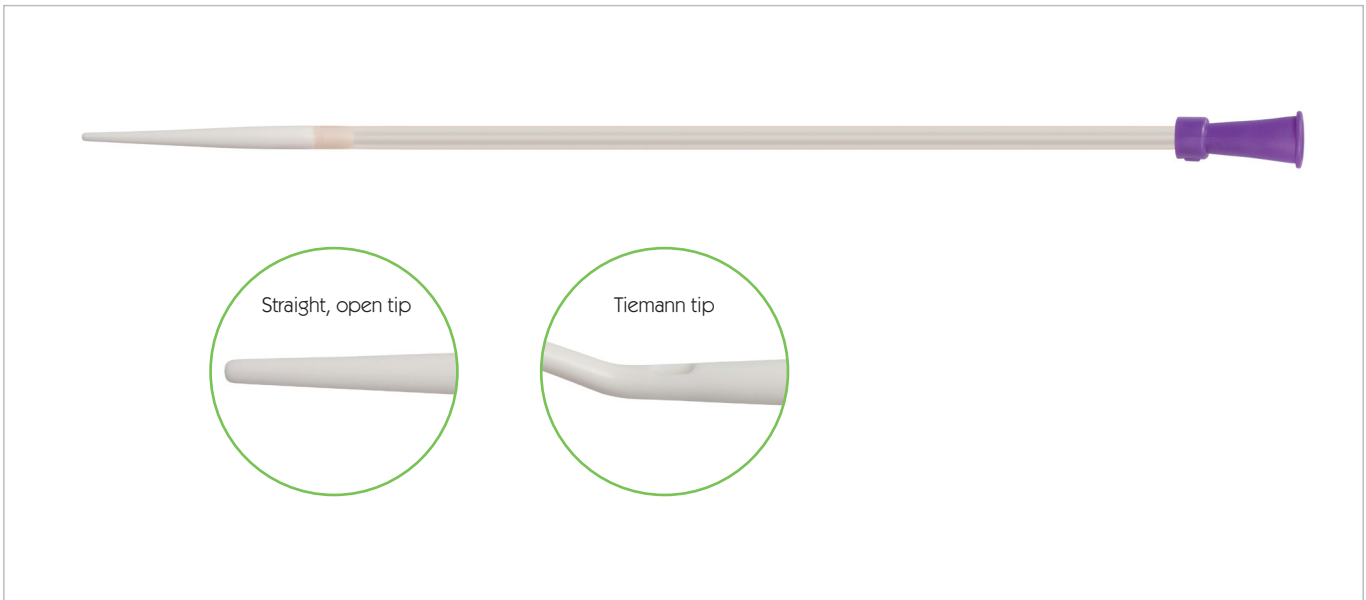

Extension catheter

- ◆ Nongraduated expansion of urethra, so there is only a single lesion in the mucous membrane
- ◆ Patient-friendly longitudinal passage (pain-free)
- ◆ Low recurrence rate of urethral strictures

Straight, open tip		
Order number	Size (CH/FR)	Length (cm)
EK-811022	10-22	40

Tiemann tip		
Order number	Size (CH/FR)	Length (cm)
EK-801022	10-22	40

VISIOKON CATHETER

100% silicone, for x-ray imaging of female urethra

DESCRIPTION

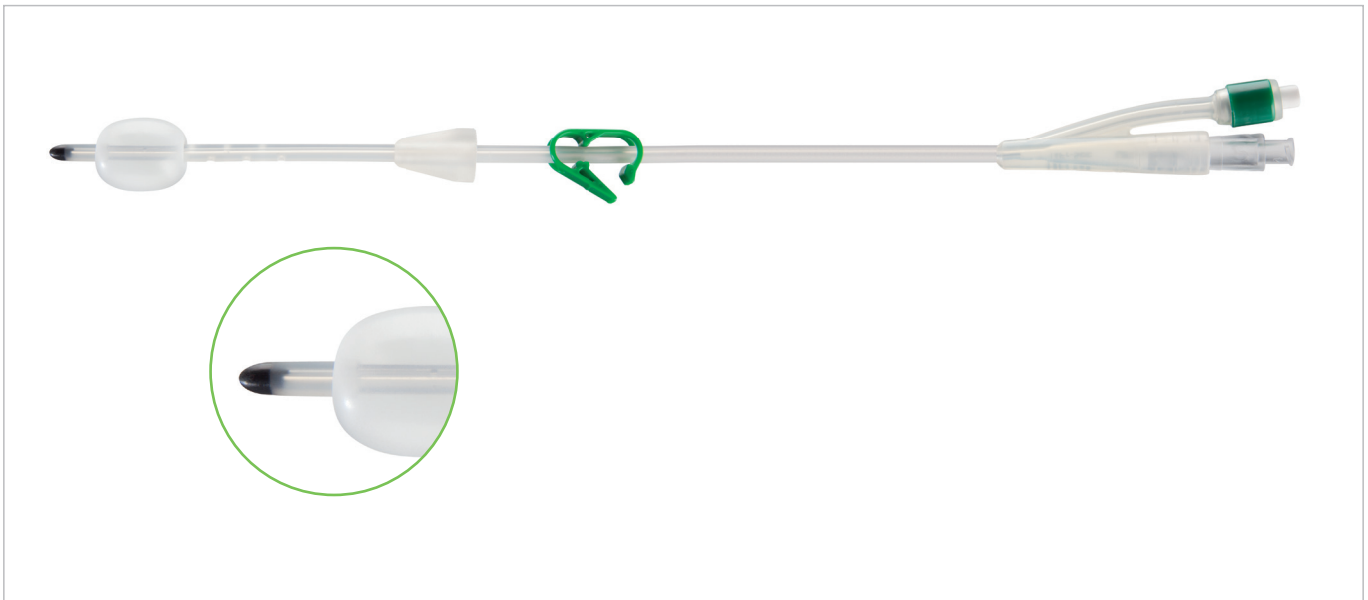

Balloon Catheter

- ◆ Silicone for optimal tissue compatibility
- ◆ X-ray contrast strips provide optimal visibility along the entire length of the catheter
- ◆ Pinch clamp for securing the cone
- ◆ Catheter and cone made of 100% silicone with additional Visioslide coating for improved lubricating properties

Order number	Size (CH/FR)	Length (cm)	Balloon capacity (ml)
PI-230	14	40	10

WWW.UROVISION.DE



UROVISION

Medi-Globe-Strasse 1-5
D-83101 Achenmühle,
Germany

☎ +49 (0) 80 32 / 973 - 400
📠 +49 (0) 80 32 / 973 - 411

URINE DRAINAGE
SYSTEMS



URINE DRAINAGE SYSTEMS

Urine drainage bag	12.1
Drainage bag Holders & One-Leg Pants	12.9

STANDARD BEDSIDE BAG

Urine drainage bag

DESCRIPTION



UVD-3

- ◆ Closed urine drainage system, 2000 ml bag volume
- ◆ Drainage tube with kink-resistant star-shaped profile
- ◆ 120 cm tube length with sliding clamp
- ◆ Odor-proof bag foil
- ◆ Standard gradation
- ◆ One-hand tap with open holder
- ◆ 2 universal hooks with cord for fastening
- ◆ Sliding clamp and bed sheet clip
- ◆ Drip chamber with anti-reflux valve
- ◆ Urine sampling port
- ◆ Sterilized

Standard Bedside Bag		
Order number	Bag volume (ml)	Tube attachment (cm)
UVD-3	2000	120

STANDARD BEDSIDE BAG

Urine drainage bag

DESCRIPTION



UVD-A4

- ◆ Urine drainage system, 2000 ml bag volume
- ◆ Anti-reflux valve
- ◆ Standard gradation
- ◆ Urine sampling port
- ◆ Tap
- ◆ Drainage tube with kink-resistant star-shaped profile
- ◆ Tube length of 120 cm
- ◆ Sterilized

UVD-A4 KH

- ◆ Urine drainage bag, 1500 ml bag volume
- ◆ Gradation
- ◆ Anti-reflux block
- ◆ Large connector
- ◆ No tap
- ◆ Tube length of 90 cm
- ◆ Sterilized



Standard Bedside Bag		
Order number	Bag volume (ml)	Tube attachment (cm)
UVD-A4	2000	120
UVD-A4 KH	1500	90

Plastic Holder
Order number
M02175NS

COMFORT BEDSIDE BAG

Closed Urine Drainage System and Bedside Bag

DESCRIPTION



Comfort Bedside Bag

- ◆ Gradation and odor-proof bag foil
- ◆ Drip chamber with foil anti-reflux valve provides optimal protection from rising germs
- ◆ One-hand tap with open holder
- ◆ Stable, removable nylon hook and cord for fastening to the bed
- ◆ Sliding clamp
- ◆ Bed sheet clip
- ◆ Soft, kink-resistant tube
- ◆ Urine sampling port
- ◆ Sterilized



Comfort Bedside Bag		
Order number	Bag volume (ml)	Tube attachment (cm)
UVD-47587	2000	120
M020365S	2500	120

Plastic Holder	
Order number	
M02175NS	

UROSID® ONE-CHAMBER LEG BAG

Leg bag with additional connector

DESCRIPTION



One-Chamber Leg Bag

- ◆ Soft and length-adjustable tube
- ◆ Short bag length due to retractable tap
- ◆ Anti-reflux block
- ◆ Attachment piece for night bag
- ◆ One-handed operation of tap
- ◆ Sterilized

Order number	Bag volume (ml)	Tube attachment (cm)	Suitable velcro straps
69 17 70	750	50	74.5766.XXX

Commercial products distributed by UROVISION.

VELCRO STRAPS

For fastening leg bags



31377

- ◆ Day and night
- ◆ Washable
- ◆ Universal size
- ◆ Packaged in pairs

Order number	Packaging (pieces)	Leg circumference = Length (mm)	Suitable for leg bag
31377	2	Universal size	5079 5081 5083

Commercial products distributed by UROVISION.



74.5766.XXX

- ◆ Skin-friendly padding
- ◆ Washable
- ◆ Wide elastic model

Order number	Packaging (pieces)	Leg circumference = Length (mm)	Suitable for leg bag
74.5766.001	1	380-430 (S)	74.58XX.005 U-750-X
74.5766.002	1	440-530 (M)	74.58XX.005 U-750-X
74.5766.003	1	550-650 (L)	74.58XX.005 U-750-X

Commercial products distributed by UROVISION.



UVD-591005

- ◆ Adjustable length
- ◆ For fastening to upper or lower leg
- ◆ Silicone straps secure against slippage
- ◆ Packaged in pairs

Order number	Packaging (pieces)	Leg circumference = Length (mm)	Suitable for leg bag
UVD-591005	2	Universal size	74.58XX.005 U-750-X

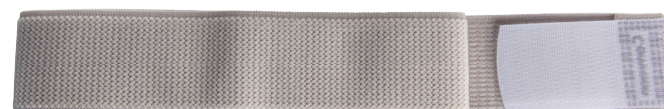

UVD-50501

- ◆ Skin-friendly padding
- ◆ Washable
- ◆ Buttons for fastening to the bag
- ◆ Packaged in pairs

Order number	Packaging (pieces)	Leg circumference = Length (mm)	Suitable for leg bag
UVD-50501	2	Universal size	516X 517X

BEDSIDE BAG HOLDERS & ONE-LEG PANTS

Bedside Bag Holders

- ◆ Bedside bag holders for all bedside bag sizes and shapes
- ◆ Can be closed with velcro strap
- ◆ Discreet case for the urine drainage bag



Order number
BETTBLTA FEMALE
BETTBLTA MALE
BETTBLTA NEUTRAL

One-Leg Pant for Leg Bag

- ◆ Leg bag holder for commercially available leg bags
- ◆ Can be washed at 95°C
- ◆ Skin-friendly and stretchable waistband
- ◆ High level of wearing comfort, with no constriction of leg
- ◆ Opening for tap for easier emptying of the bag
- ◆ Secure fastening of the urine bag
- ◆ Over-the-counter aid



Order number	Size	Waist (cm)
EB-15611	S (severity level)	50 - 64
EB-15612	M	65 - 85
EB-15613	L	86 - 100
EB-15614	XL	Over 101

Commercial products distributed by UROVISION.

PEDIATRICS



PEDIATRICS

Ureteral Stents and Sets	13.1
Pyeloplasty Catheters	13.2
RENOVISION Nephrostomy	13.3
SUPRAVISION PUR Sets	13.4
VISIOCATH Balloon Catheters, silicone	13.5

VISIOSTAR STANDARD Double-J Ureteral Stent Set

DESCRIPTION

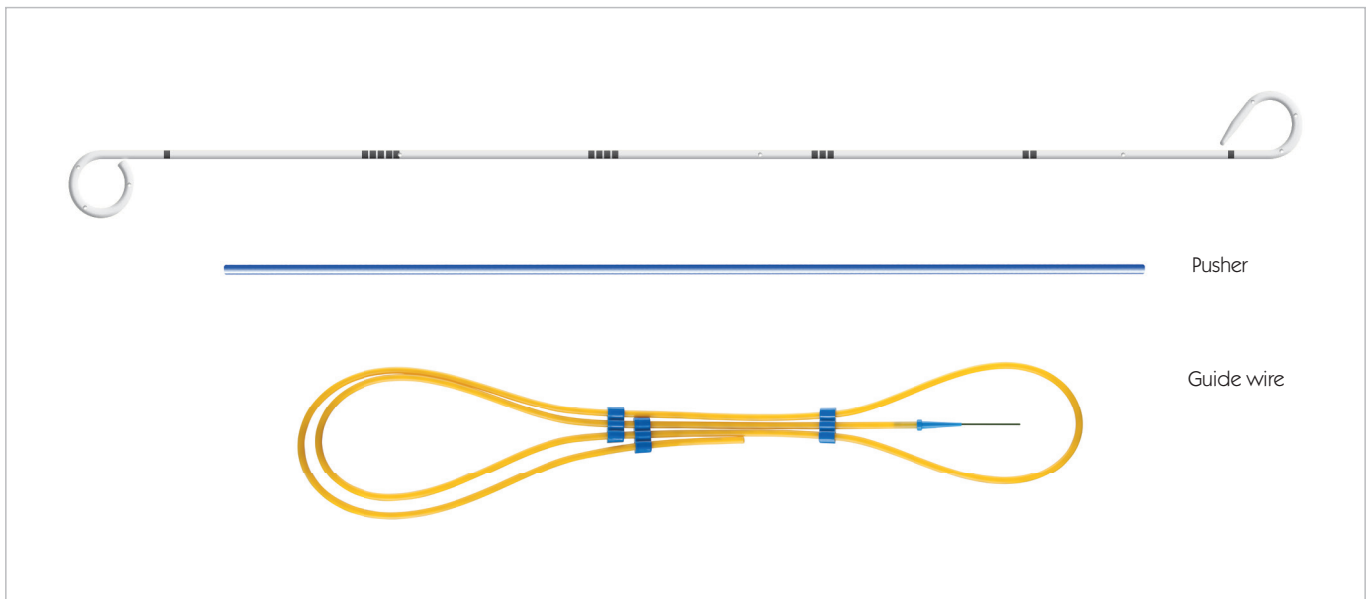

Ureteral Stent

- ◆ Polyurethane
- ◆ Drainage openings in pigtails and shaft
- ◆ Open or closed tip
- ◆ Markings for exact positioning
- ◆ Radiopaque

Pusher

- ◆ Length: 40 cm

Guide wire

- ◆ PTFE coating

Clip

- ◆ In sets with closed tip

URETERAL STENTS

VISIOSTAR STANDARD Double-J Ureteral Stent Set

Open tip							
Order number with guide wire	Order number without guide wire	Size (CH/FR)	Length (cm)	Wire (inch)	Wire length (cm)	Wire tip	Wire stiffness
ST-190308	ST-197308	3	8	0.018"	150	straight	standard
ST-190310	ST-197310	3	10	0.018"	150	straight	standard
ST-190312	ST-197312	3	12	0.018"	150	straight	standard
ST-190315	ST-197315	3	15	0.018"	150	straight	standard
ST-190318	ST-197318	3	18	0.018"	150	straight	standard
ST-190320	ST-197320	3	20	0.018"	150	straight	standard
ST-190408	ST-197408	4	8	0.025"	150	straight	standard
ST-190410	ST-197410	4	10	0.025"	150	straight	standard
ST-190412	ST-197412	4	12	0.025"	150	straight	standard
ST-190415	ST-197415	4	15	0.025"	150	straight	standard
ST-190418	ST-197418	4	18	0.025"	150	straight	standard
ST-190420	ST-197420	4	20	0.025"	150	straight	standard
ST-194708	ST-1974708	4.7	8	0.028"	150	straight	standard
ST-194710	ST-1974710	4.7	10	0.028"	150	straight	standard
ST-194712	ST-1974712	4.7	12	0.028"	150	straight	standard
ST-194715	ST-1974715	4.7	15	0.028"	150	straight	standard
ST-194718	ST-1974718	4.7	18	0.028"	150	straight	standard
ST-194720	ST-1974720	4.7	20	0.028"	150	straight	standard

Closed tip							
Order number with guide wire	Order number without guide wire	Size (CH/FR)	Length (cm)	Wire (inch)	Wire length (cm)	Wire tip	Wire stiffness
ST-180308		3	8	0.018"	150	straight	standard
ST-180310		3	10	0.018"	150	straight	standard
ST-180312		3	12	0.018"	150	straight	standard
ST-180315		3	15	0.018"	150	straight	standard
ST-180318		3	18	0.018"	150	straight	standard
ST-180320		3	20	0.018"	150	straight	standard
ST-180408		4	8	0.025"	150	straight	standard
ST-180410		4	10	0.025"	150	straight	standard
ST-180412		4	12	0.025"	150	straight	standard
ST-180415		4	15	0.025"	150	straight	standard
ST-180418		4	18	0.025"	150	straight	standard
ST-180420		4	20	0.025"	150	straight	standard
ST-184708	ST-1954708	4.7	8	0.028"	150	straight	standard
ST-184710	ST-1954710	4.7	10	0.028"	150	straight	standard
ST-184712	ST-1954712	4.7	12	0.028"	150	straight	standard
ST-184715	ST-1954715	4.7	15	0.028"	150	straight	standard
ST-184718	ST-1954718	4.7	18	0.028"	150	straight	standard
ST-184720	ST-1954720	4.7	20	0.028"	150	straight	standard

PYELOPLASTY CATHETERS

For pyeloplasty

DESCRIPTION

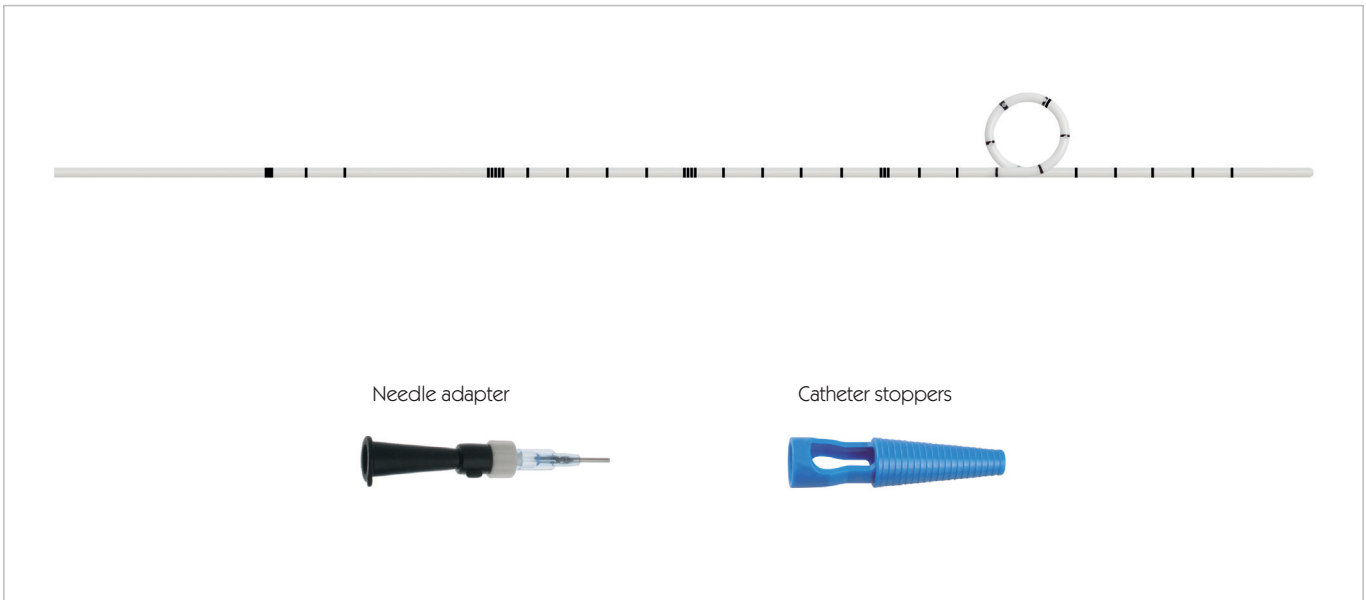

Catheter

- ◆ Polyurethane
- ◆ Drainage openings in pigtail and ureter section
- ◆ With straight tip
- ◆ Open tip
- ◆ Markings for exact positioning
- ◆ Radiopaque

Adapter

- ◆ For attaching to the urine drainage bag

With straight tip					
Order number	Size (CH/FR)	Length (cm)	Length of ureter section (cm)	Length of drainage section (cm)	Maximum guide wire
UR-910435	4	35	7	24	0.025"
UR-910535	4.7	35	7	24	0.028"
UR-910635	6	35	7	24	0.035"
UR-910835	8	35	7	24	0.038"

RENOVISION NEPHROSTOMY Puncture and Exchange Set with pigtail catheter

SET COMPONENTS

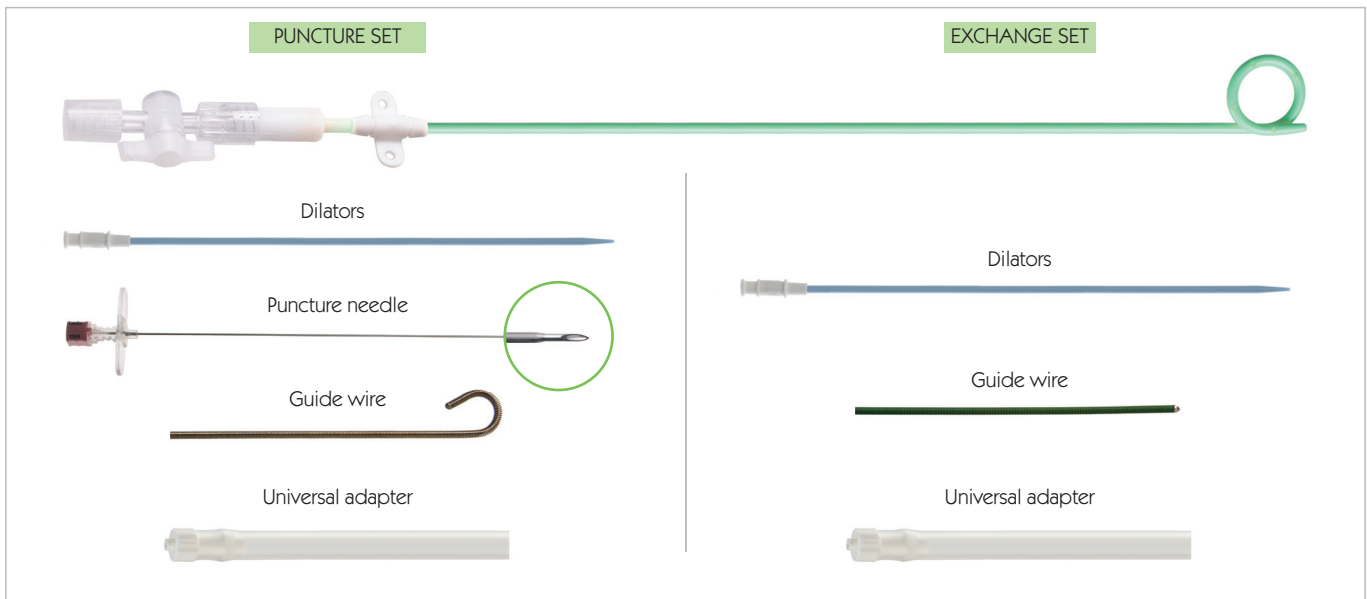

Nephrostomy Catheter

- ◆ Polyurethane
- ◆ Drainage openings in pigtail
- ◆ Luer Lock Connection

Puncture Needle

- ◆ 2-part needle
- ◆ Medical stainless steel
- ◆ 20 G, 15 cm in length

Guide Wire (Lunderquist)

- ◆ PTFE coating

Universal Adapter

- ◆ Luer lock connection and silicone tube attachment (polyurethane coating)
- ◆ Length: 10 cm

Single catheter		
Order number	Size (CH/FR)	Length (cm)
RN-480630	6	30

Puncture Set							
Order number	Size (CH/FR)	Length (cm)	Dilators	Wire (inch)	Wire length (cm)	Wire tip (r=1.5 mm)	Wire stiffness
RN-440630	6	30	05/06/07	0.025"	70	J-tip	stiff

Exchange Set							
Order number	Size (CH/FR)	Length (cm)	Dilators	Wire (inch)	Wire length (cm)	Wire tip	Wire stiffness
RN-450630	6	30	05/06/07	0.025"	70	straight	stiff

SUPRAVISION PUR Puncture and Exchange Set with pigtail and funnel

SET COMPONENTS

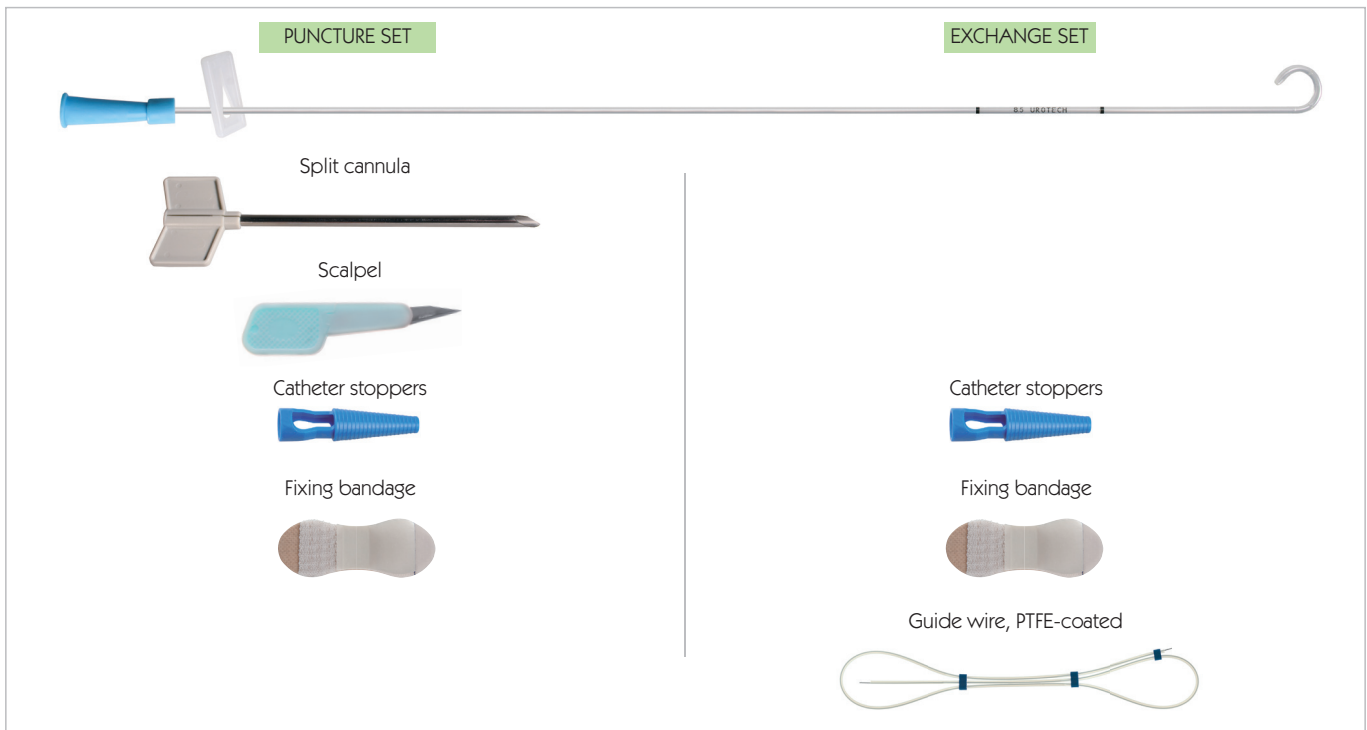

Pigtail catheter

- ◆ Polyurethane
- ◆ Flexible pigtail prevents irritation
- ◆ Funnel for attaching a urine drainage bag
- ◆ Markings for exact positioning



Puncture Set				
Order number	Size (CH/FR)	Length (cm)	Split cannula diameter size (mm)	Split cannula length (mm)
SV-378550	08	50	3.6	80

Exchange Set						
Order number	Size (CH/FR)	Length (cm)	Wire (inch)	Wire length (cm)	Wire tip	Wire stiffness
SV-378551	08	50	0.038"	100	straight	standard

VISIOCATH BALLOON CATHETER

With VISIOSLIDE special coating and stiffening mandrin, 100% silicone

DESCRIPTION

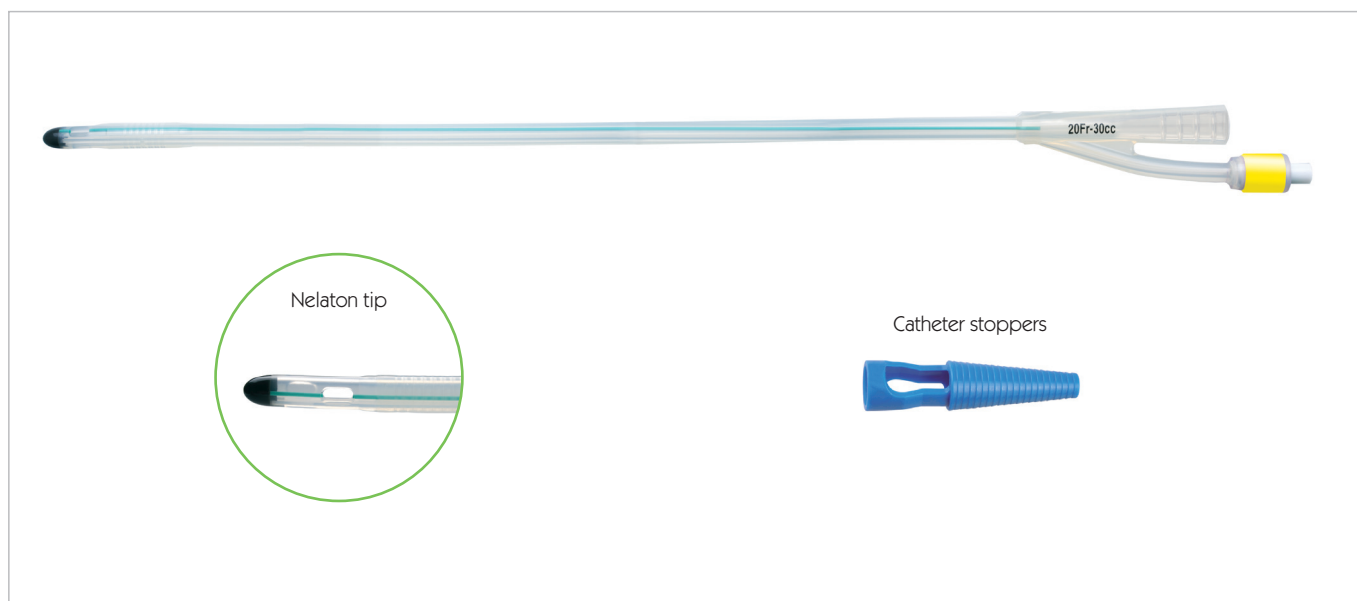

Balloon Catheter

- ◆ With VISIOSLIDE special coating or uncoated (standard)
- ◆ Nelaton tip
- ◆ Silicone for optimal tissue compatibility
- ◆ A high level of balloon stability with low diffusion
- ◆ Reinforced funnel attachment to prevent funnel from ripping and to enable secure connection of the urine drainage bag
- ◆ Transparent with integrated x-ray contrast strips

VISIOSLIDE Special Coating

- ◆ Improved lubricating properties, wear-resistant inside and outside
- ◆ Lower propensity for encrustation, increasing life cycle

Order number	Size (CH/FR)	Length (cm)	Balloon capacity (ml)
KW-450603-SC	6	30	1.5
KW-450803-SC	8	30	3
KW-451003-SC	10	30	3

SPECIAL PRODUCTS



SPECIAL PRODUCTS

Ureteral Access Sheath	14.1
Flexible Injection Needle	14.2
Ureteral Occlusion Catheter	14.4
Magnusson Locking System	14.5

URETERAL ACCESS SHEATH

with atraumatic needle transition

DESCRIPTION

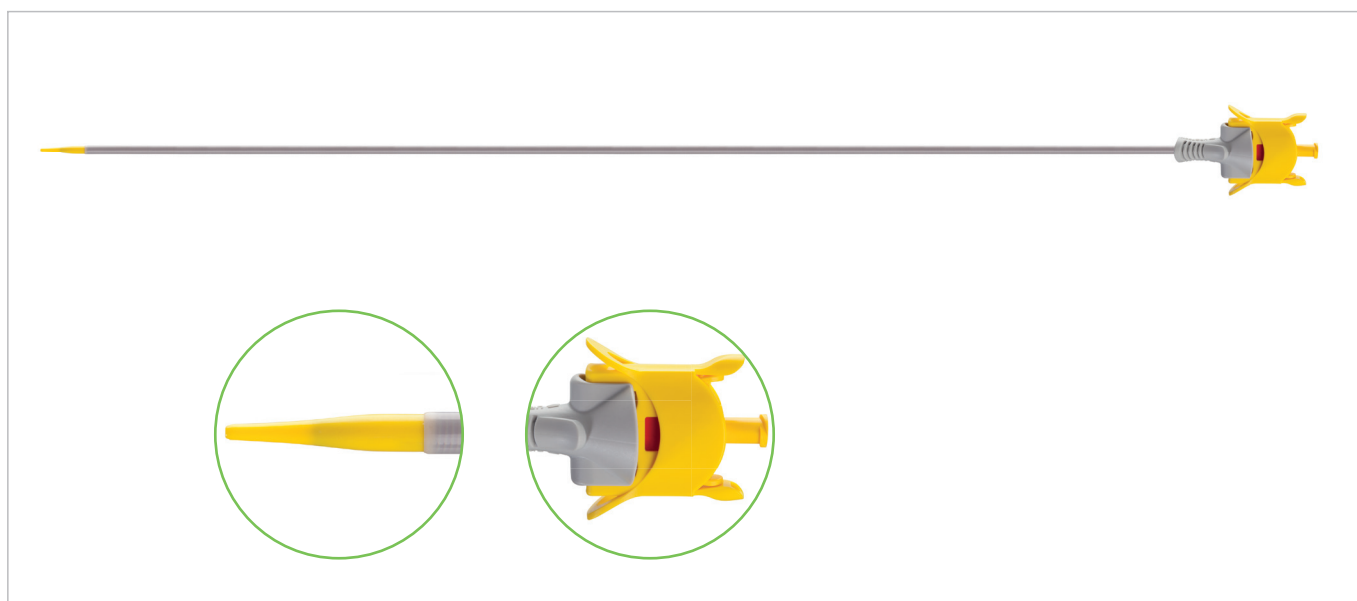

Ureteral Access Sheath

- ◆ Unique tip system for atraumatic transition between dilator and sheath
- ◆ Secure fixation system from dilator to sheath
- ◆ Visual monitoring of fixing for dilator and sheath
- ◆ PTFE operation canal allows for minimal friction when inserting instruments
- ◆ Radiopaque visibility of sheath and dilator tip facilitates safe placement
- ◆ Hydrophilic coating enables comfortable insertion of sheath
- ◆ High kink-resistance of the sheath due to integrated metal coil

Order number	Inner diameter (CH/FR)	Outer diameter (CH/FR)	Length (cm)
AS-1235	10	12	35
AS-1245	10	12	45
AS-1435	12	14	35
AS-1445	12	14	45
AS-1635	14	16	35
AS-1645	14	16	45

Commercial products distributed by UROVISION.

FLEXIBLE INJECTION NEEDLE

For injecting bulking agents

DESCRIPTION

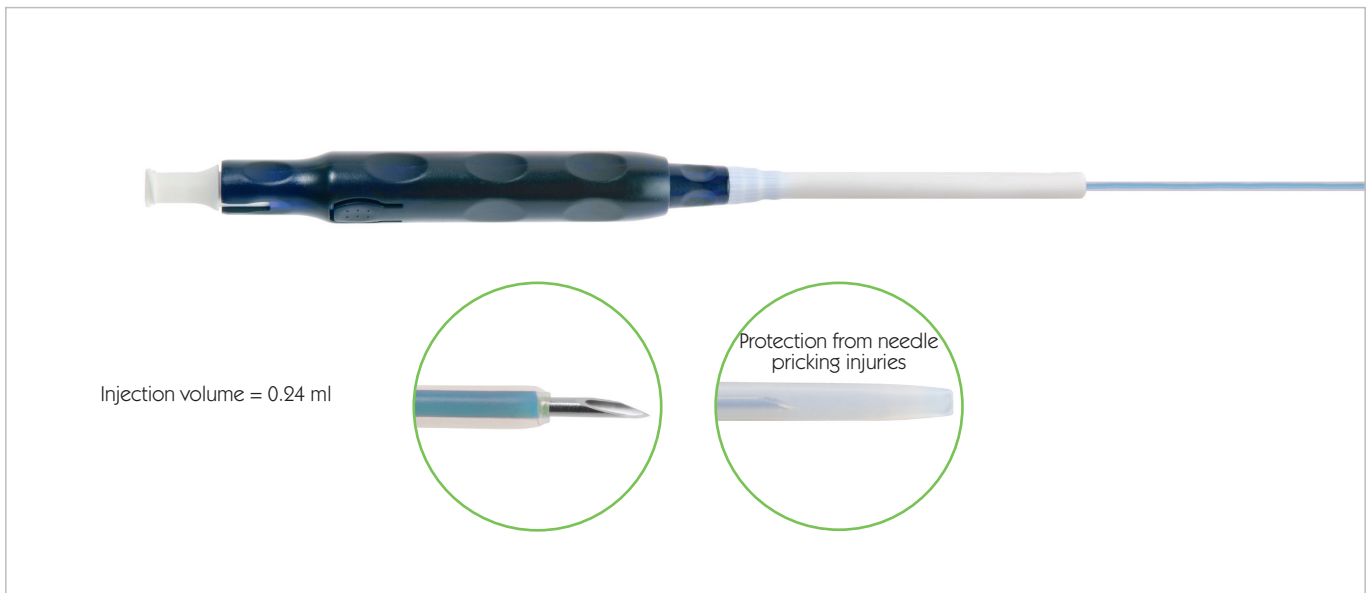

Flexible Injection Needle (Injectra)

- ◆ Safe needle control and protection from pricking due to locking mechanism
- ◆ Ergonomic handle
- ◆ Stainless steel needle with 15° beveling guarantees optimal insertion properties

Order number	Size (FR/CH)	Needle diameter (G)	Needle length (mm)	Operating length (cm)
FIN-57-066	6	22	4	66

FLEXIBLE INJECTION NEEDLE

For injecting bulking agents

DESCRIPTION

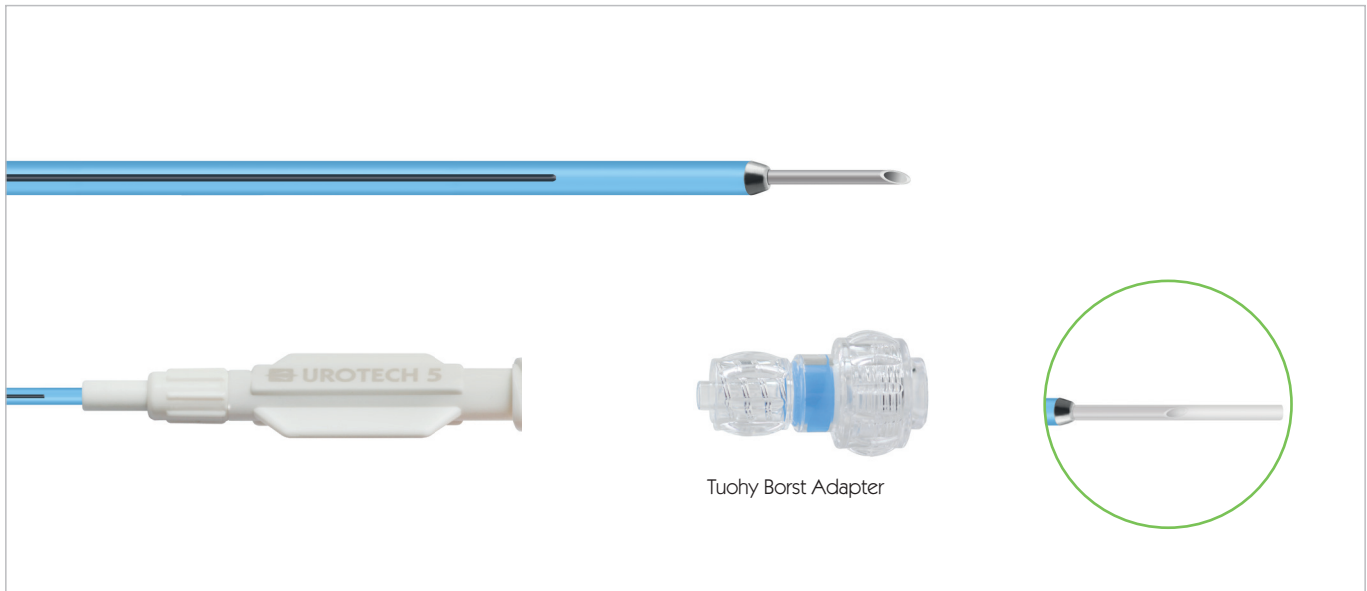

Short flexible needle

- ◆ With Tuohy Borst adapter for fixing to the operation canal of the cystoscope and for injection protection
- ◆ Simple and continuous orientation of injection (angle) using longitudinal markings

Order number	Size (FR/CH)	Needle diameter (G)	Needle length (mm)	Operating length (cm)
Flexible needle (injection volume: 0.9 ml)				
FIN-05-380	05	23	8	38
FIN-06-380	06	21	8	38
Flexible needle (injection volume: 0.9 ml) with Tuohy Borst adapter				
FIN-TB-05-360	05	23	8	36
FIN-TB-06-360	06	21	8	36

URETERAL OCCLUSION CATHETER

DESCRIPTION

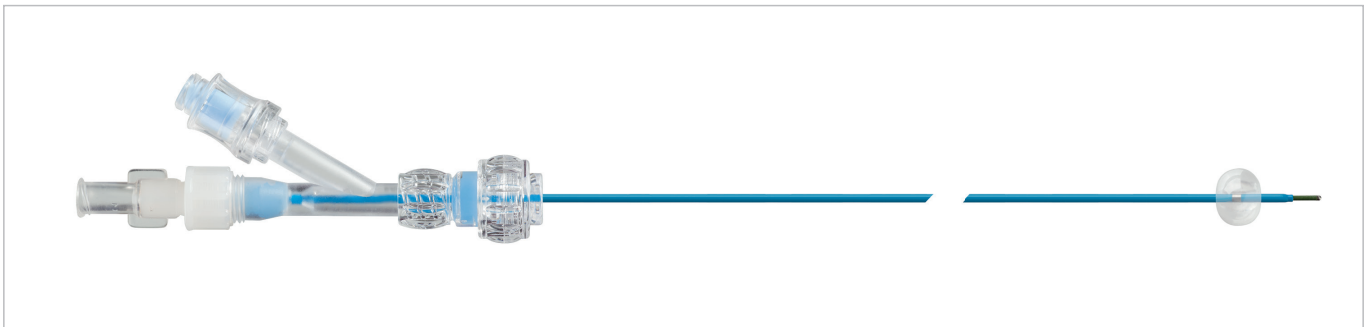

Ureteral Occlusion Catheter

- ◆ Hydrophilic tip for easy insertion of the catheter
- ◆ Additional platinum ring at the middle of the balloon for secure localization
- ◆ Non-demarcated transition from shaft to balloon
- ◆ Latex-free balloon
- ◆ Balloon fluid can be actively withdrawn with the syringe
- ◆ Adapter can be connected easily

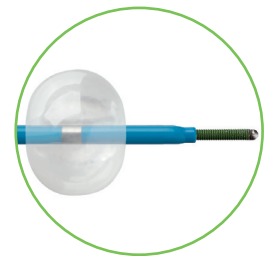

Order number	Size (FR/CH)	Size of tip (FR/CH)	Length (cm)	Balloon capacity (ml)	Mandrin length (cm)	Mandrin diameter (inch)
OK-05-75	5	4	75	1	84	0.035"

MAGNUSSON LOCKING SYSTEM Nephrostomy Puncture/Exchange Set Seldinger technique, PC-treated, with pigtail, with suture

SET COMPONENTS

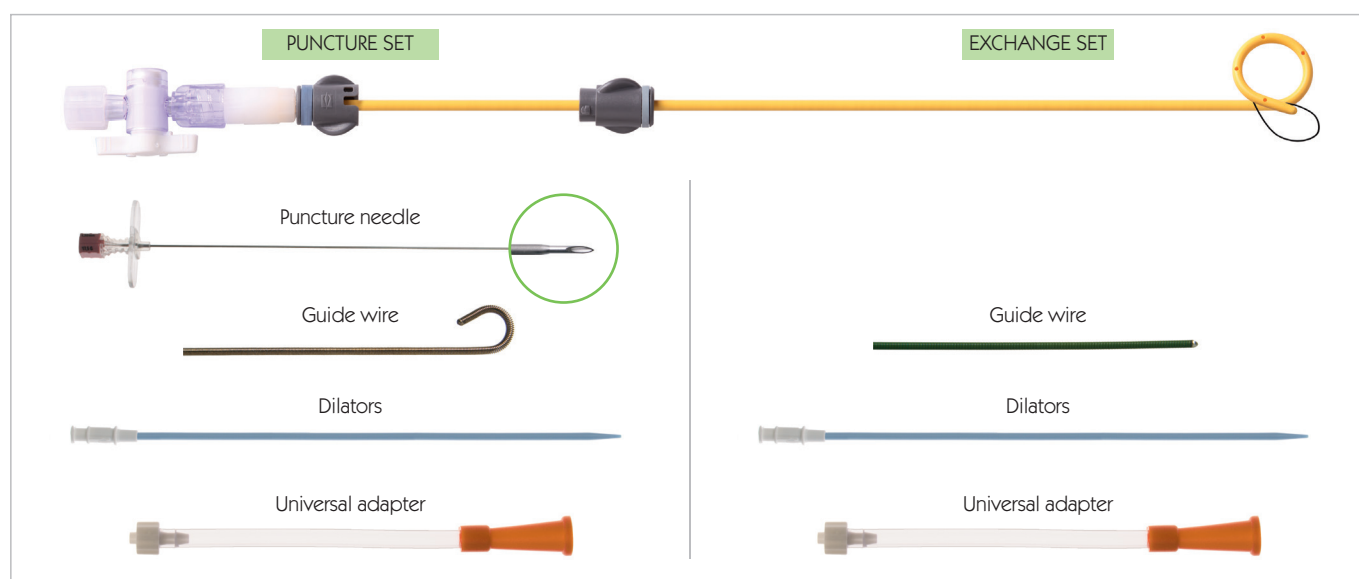

Nephrostomy Catheter

- ◆ Polyurethane
- ◆ PC treatment for lowering the risk of infection and encrustation, which can extend the indwelling time
- ◆ Controlled and complete closure of pigtail through a patented closure system with suture
- ◆ Drainage openings in pigtail
- ◆ Luer lock connection

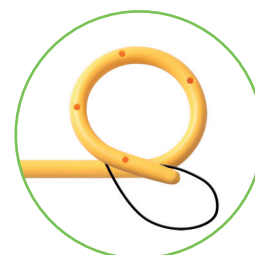

Puncture Needle

- ◆ 2-part needle
- ◆ Medical stainless steel
- ◆ 18 G, 20 cm in length
- ◆ Visible in ultrasound

Guide Wire (Lunderquist)

- ◆ PTFE coating

Universal Adapter

- ◆ Luer lock attachment and funnel for connecting a urine drainage bag
- ◆ Length: 10 cm

MAGNUSSON LOCKING SYSTEM Nephrostomy Puncture/Exchange Set

Seldinger technique, PC-treated, with pigtail, with suture

Single catheter		
Order number Pigtail catheter	Size (FR/CH)	Length (cm)
RP-410840-FI	8	24
RP-410850-FI	8	34
RP-410940-FI	9	24
RP-410950-FI	9	34
RP-411050-FI	10.5	30

Puncture set							
Order number Puncture set	Size (FR/CH)	Length (cm)	Dilators (FR/CH)	Wire length (cm)	Wire diameter	Wire tip (r=1.5 mm)	Wire stiffness
RP-400840-FI	8	24	07/09	80	0.035"	J-tip	stiff
RP-400850-FI	8	34	07/09	80	0.035"	J-tip	stiff
RP-400940-FI	9	24	08/10	80	0.035"	J-tip	stiff
RP-400950-FI	9	34	08/10	80	0.035"	J-tip	stiff
RP-401050-FI	10.5	30	08/12	80	0.035"	J-tip	stiff

Exchange set							
Order number Exchange set	Size (FR/CH)	Length (cm)	Dilators (FR/CH)	Wire length (cm)	Wire diameter	Wire tip	Wire stiffness
RP-400842-FI	8	24	08/09	80	0.035"	straight	stiff
RP-400852-FI	8	34	08/09	80	0.035"	straight	stiff
RP-400942-FI	9	24	09/10	80	0.035"	straight	stiff
RP-400952-FI	9	34	09/10	80	0.035"	straight	stiff
RP-401052-FI	10.5	30	10/12	80	0.035"	straight	stiff

Commercial products distributed by UROVISION.